

Infiniium Oscilloscope Probes and Accessories

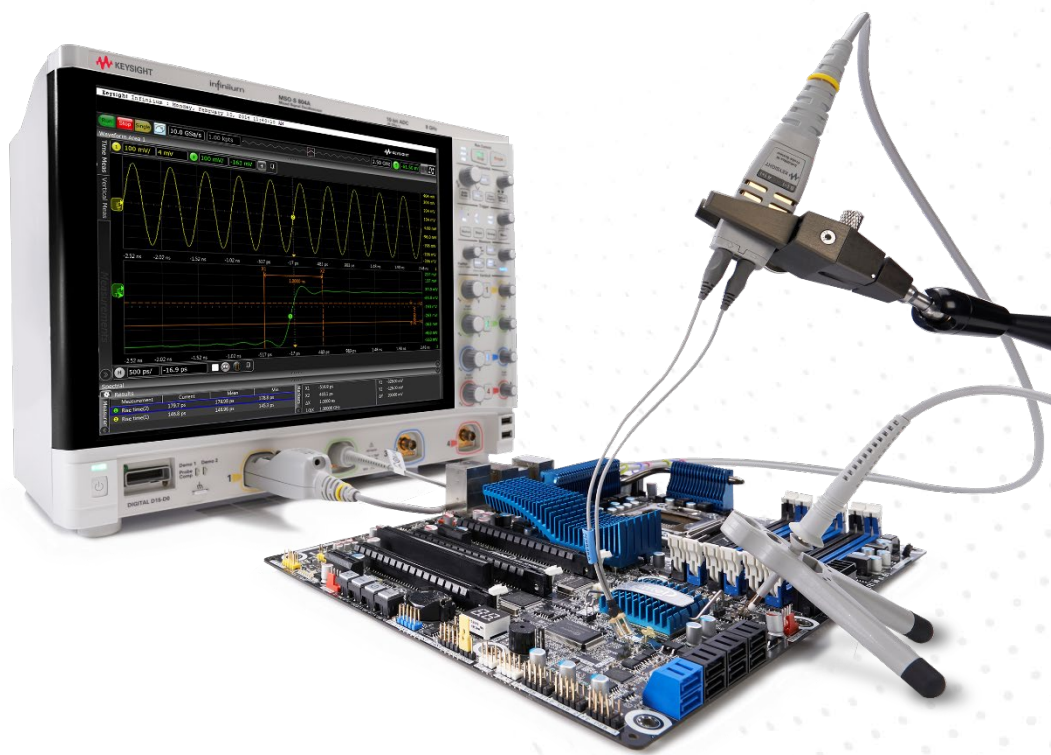

To get the most out of your Keysight Technologies, Inc. Infiniium oscilloscope, you need the right probes and accessories for your particular applications. Whether you need the high bandwidth and low loading of an active probe, an easy way to connect to surface mount ICs, or a passive probe to measure high voltages, there's a wide selection of high-quality probes and accessories for your Infiniium oscilloscope.

Table of Contents

Probe Compatibility Table	3
InfiniiMax Active Probe System Overview	4
InfiniiMax Ultra Series	12
InfiniiMax RC Probe	14
InfiniiMax Gen III/III+ Probes	19
InfiniiMax Gen II Probes	28
InfiniiMax Gen I Probes	33
Optical-to-Electrical Converters — N7005A 60 GHz	37
Optical-to-Electrical Converters — N7004A 33 GHz	38
Active Termination Adapter — N7010A	41
InfiniiMode Active Probes — N2750A/51A/52A	43
Single-Ended Active Probes — N2795A/96A/97A	48
Power Rail Probes — N7020A 2 GHz Power Rail Probe	51
Power Rail Probes — N7024A 6 GHz Power Rail Probe	52
High-Voltage Differential Probes — DP0001A	53
High-Voltage Differential Probes — N2790A/91A/891A	55
High-Voltage Differential Probes — N2804A/05A	56
General Purpose Differential Probes — N2818A/19A	58
AC/DC Current Probes — 1146B	59
AC/DC Current Probes — 1147B/N2893A/N7026A	60
AC/DC Current Probes — N2780B/81B/82B/83B/83L	62
Rogowski Coil AC Current Probes — N7040A/41A/42A	64
High-Sensitivity Current Probes — N2820A/21A	65
General Purpose Passive Probes — N2870A-76A	67
Extreme Temperature Passive Probe — N7007A	71
High Voltage Passive Probes — 10076C	72
Accessories — Mixed Signal Oscilloscope Logic Probes	74
Accessories — N2744A T2A Probe Interface Adapter	77
Accessories — N2784A/85A/86A/87A Probe Positioners	79
Accessories — Wedge Probe Adapters	80
Accessories — Fine Pitch and PC Board Accessories	81
Related Literature	83

Probe Compatibility Table

To assist you in selecting the proper probe for your application use our probe compatibility table below to find the probes that are recommended for use with your Infiniium scope. To best help you in probe selection, check out our [Oscilloscope Probe Selection Guide](#). For the most up-to-date compatibility between the probes and scopes, check out the [Probe Resource Center](#).

	MXR/EXR Series	S-Series	90000/90008A Series ¹	V-Series, 90000X/Q, Z-Series	UXR Series
Scope bandwidth	500 MHz to 6 GHz	500 MHz to 8 GHz	2.5 to 13 GHz	8 to 33 GHz (V-Series) 13 to 33 GHz (90000X) 16 to 63 GHz (90000Q) 20 to 63 GHz (90000Z)	5 to 110 GHz, both AutoProbe II (3.5 mm) and AutoProbe III (1 and 1.85 mm) models
Probe interface	AutoProbe	AutoProbe	AutoProbe	AutoProbe II	AutoProbe II (3.5 mm models), AutoProbe III (1 and 1.85 mm models) ²
Standard probe	N2873A	N2873A			
InfiniiMax active probing system, page 5	N2830A/31B/32B, 1130B/31B/32B/34B, 1168B/69B	N2830A/31B/32B, 1130B/31B/32B/34B, 1168B/69B	N2830A/31B/32B, 1131B/32B/34B, 1168B/69B	1168B/69B with N5442A, N2801A/02A/03A, N7000A/01A/02A/03A, MX0020/21/22/23/24/25A	1168/69B with N5442A, N2801A/02A/03A, N7000A/01A/02A/03A, MX0020/21/22/23/24/25A ²
Optical probe, page 32	—	—	—	N7004A	N7004A, N7005A ²
Active termination adapter, page 34	—	—	—	N7010A	N7010A ²
InfiniiMode active probes, page 36	N2750A/51A/52A	N2750A/51A/52A	N2750A/51A /52A	N2750A/51A/52A with N5442A	N2750A/51A/52A with N5442A ²
Single-ended active probes, page 39	N2795A/96A/97A	N2795A/96A/97A	N2795A/96A/97A	N2795A/96A/97A with N5442A	N2795A/96A/97A with N5442A ²
Power rail probes, page 42	N7020A, N7024A	N7020A, N7024A	N7024A	N7024A with N5442A	N7024A with N5442A ²
General purpose differential active probes, page 54	N2790A/91A, N2818A/19A, N2804A/05A, DP0001A	N2790A/91A, N2818A/19A, N2804A/05A, DP0001A	N2791A/N2891A with E2697A, N2818A/19A/04A/05A, DP0001A	N2790A/91A/891A with N5449A, N2818A/19A/04A/05A with N5442A, DP0001A with N5442A	DP0001A with N5442A ²
Current probes, page 47	1146B/47B, N2780B/81B/82B/83B/ N2893A, N7026A, N2820A/21A, N7040A/41A/42A	1146B/47B, N2780B/81B/82B/83B/ N2893A, N7026A, N2820A/21A, N7040A/41A/42A	1146B, N2780B/81B/82B/83B, N7040A/41A/42A with E2697A	1147B, N2893A with N5449A	1147B, N2893A ²
General purpose passive probes, page 52	N2870A-76A, 10073D, 10070D, N7007A (extreme temp)	N2870A-76A, 10073D, 10070D, N7007A (extreme temp)	N2870A-76A, 10073D, 10070D, N7007A (extreme temp) with E2697A	N2873A with N5449A (N5449A includes one N2873A)	N2873A with N5449A (N5449A includes one N2873A) ²
High voltage passive probe, page 60	10076C	10076C	10076C	10076C with N5449A	

1. The 1147B, N2790A and N2893A are not compatible with 80000, 90000 and 90008 Series scopes.

2. UXR with AutoProbe III interface (1 and 1.85 mm models) requires N2852A interface adapter to accommodate probes with AutoProbe II interface.

InfiniiMax Active Probe System Overview

For All High-Speed Digital Design Engineers

Get the highest performance available for measuring differential and single-ended signals on high-density ICs and PCBs. As devices get smaller and faster, accurately probing signals becomes more challenging. Keysight's InfiniiMax Probing System has the most accurate probe amplifiers, the widest variety of probe heads, and all the accessories you need to get the job done.

Best Accuracy

- Highest bandwidth, up to 30 GHz probe amplifier
- Industry's lowest probe loading and noise gives you a more accurate representation of your signals
- S-parameter corrections for a more accurate probe response
- Flat frequency response over the entire bandwidth eliminates distortion and ensures accurate measurement

Easy-to-Use

- The widest variety of probe heads and accessories available on the market
- InfiniiMode technology enables you to measure differential, single-ended A or B, and common-mode without having to reconnect the probe
- Easily probe small devices with the super flexible micro probe head
- QuickTip heads for a quick and secure connection

Industry-Leading

- Extreme temperature probing solutions from -55 to +150 °C - enables measurements in environmental chambers
- Damping resistor tips prevent signal distortion at high frequency
- Replaceable browser tips give you improved usability and versatility
- Economical solder-in differential probing solution with Zero Insertion Force (ZIF) probe heads

InfiniiMax Family Overview

	InfiniiMax I 1130B-34B	InfiniiMax II 1168B/69B	InfiniiMax III N2801A-03A	InfiniiMax III+ N2830A-32A N7000A-03A	InfiniiMax RC MX0023A	InfiniiMax Ultra MX0020-25A
Probe interface	AutoProbe I	AutoProbe I	AutoProbe II	AutoProbe I or II	AutoProbe II	AutoProbe II
1.5 GHz	1130B					
3.5 GHz	1131B					
4 GHz				N2830A (IM)		
5 GHz	1132B					
7 GHz	1134B					
8 GHz				N2831A (IM) N7000A (IM)		
10 GHz		1168B				MX0020A (IM)
13 GHz		1169B		N2832A (IM) N7001A (IM)		MX0021A (IM)
16 GHz				N7002A (IM)		MX0022A (IM)
20 GHz			N2801A	N7003A (IM)		MX0024A (IM)
25 GHz			N2802A		MX0023A	MX0025A (IM)
30 GHz			N2803A			

IM: InfiniiMode

Note: The N2800A 16 GHz InfiniiMax III probe is discontinued and replaced by N7002A 16 GHz InfiniiMax III+ probe.

Note: The 1130B-34B and 1168B/69B are the RoHS compliant version of A models with 100% form, fit, function and performance compatible to the A counterparts.

InfiniiMax Probes Oscilloscope Compatibility

Probe-to-Scope Interface	InfiniiMax Probes	Compatible Oscilloscopes
AutoProbe I	Gen I (1130/1/2/4B) Gen II (1168/9B) Gen III+ (N2830/1/2A)	InfiniiVision 3000A, 3000T, 4000, and 6000 X-Series (except N2830A/31A/32A)
		Infiniium MXR, EXR, S-Series, 9000, and 90000A Series
		Infiniium UXR (3.5 mm models), V, Z, Q, and 90000X Series with the use of the N5442A adapter
		Infiniium UXR (1 mm and 1.85 mm models) with the cascaded use of the N5442A and N2852A adapters
AutoProbe II	Gen III (N2801/2/3A) Gen III+ (N7000/1/2/3A) RC (MX0023A) Ultra (MX0020/1/2/4/5A)	Infiniium UXR (3.5 mm models), V, Z, Q, and 90000X Series
		Infiniium UXR (1 mm and 1.85 mm models) with the use of the N2852A adapter
		Infiniium N1000A and 86100D DCA-X with the use of the N5477A adapter (only for N2801A/02A/03A)

InfiniiMax Probes Key Features

Not only do InfiniiMax probes have the best accuracy and highest performance, they also offer a wide range of features to make the InfiniiMax probing system the easiest probing system to use. Not all features are found across all generations. Check out the chart and explanations of the features below.

	InfiniiMax I/II	InfiniiMax III	InfiniiMax III+	InfiniiMax RC	InfiniiMax Ultra
Input Impedance Profile	RC	RCRC	RCRC	RC	RC
InfiniiMode	No	No	Yes	No	Yes
Auto-selected input attenuation ranges	No, only 10:1 (I), 3.45:1 (II)	No, only 6:1	Yes, 5:1 and 10:1	Yes, 1:1 and 4:1	Yes, 1:1, 4:1, and 8:1
True View and Source Estimate Probe Response Correction Modes	No	No	No	No	Yes
Probe specific DSP correction	Yes, with nominal S- parameters	Yes, with unique S- parameters	Yes, with unique S- parameters	Yes, with unique S- parameters	Yes, with unique S- parameters
Extreme Temperature Probing	Yes, with MX0100A probe head	Yes, with MX0109A probe head	Yes, with MX0109A probe head	Yes, with MX0100A probe head	Yes, with MX0100A probe head

Understanding a Probes Input Impedance Profile

An ideal probe would simply provide an exact replica of the signal being probed. But, in the real world, the probe becomes part of the circuit under test because the probe introduces loading to the circuit. The probe impedance, thus probe loading changes with frequency. To get the most accurate measurements you want the biggest probe resistance and the smallest probe capacitance across the widest frequency range. The conventional way to model probe loading is to measure the impedance of the probe in a graph of input impedance vs frequency (Figure 1).

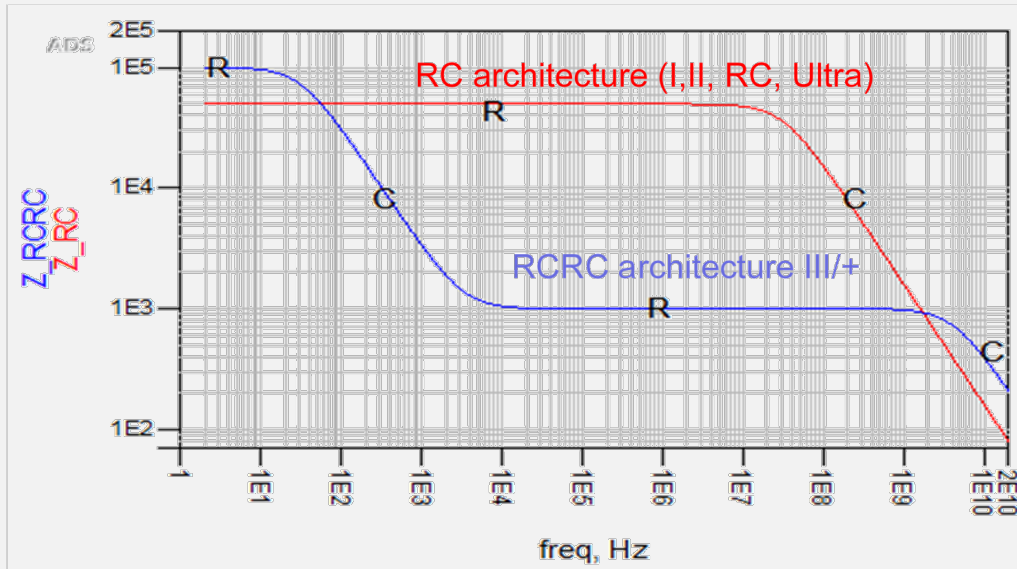

Figure 1. Input impedance profile of two common probe architectures: RC and RCRC

The InfiniiMax probes can be divided into two main categories: RC and RCRC architecture. As pictured above, an RC input impedance architecture has the lowest loading and least signal distortion across the widest frequency range. At lower frequencies, you can see that the input impedance is driven by input R of the probe. It then intersects the capacitance of the probe. The RCRC architecture is best when higher bandwidth is necessary, or for signals that have low source impedance. You can see here that at higher frequencies the RCRC input impedance is slightly higher, making it a better choice for high bandwidth measurements.

InfiniiMax I, II, RC, and Ultra all have RC architecture, whereas InfiniiMax III and III+ have RCRC architecture. You will need to choose the probe loading that best fits your application. Here are a few recommendations of when to use RC vs. RCRC probes.

RC architecture (InfiniiMax I/II/RC/Ultra)

- Best for measuring signals that transition to high impedance modes
- Highest impedance (lowest loading, least signal distortion) across the widest frequency range

RCRC architecture (InfiniiMax III/+)

- Best when higher bandwidth is necessary, or signals have low source impedance
- Probe loading can affect the circuit under test

InfiniiMode

In many of today's high-speed serial bus standards, the accurate measurement of single-ended and common-mode components of a differential signal is often compromised by having to rely on multiple probe channels and a scope's internal math functions, but these methods are prone to errors and cumbersome to use. InfiniiMode allows you to measure differential, single-ended and common-mode characteristics of a differential signal with a single connection. You will need to connect four inputs consisting of two differential signal inputs: +lead, -lead and two ground connections to make the multi-mode measurements possible with a single connection. Once you connect all input leads to the target, you don't need to reconnect the probe and it just takes one channel on the scope to make all three measurements. To make InfiniiMode measurements, you need both a probe amplifier and probe heads that are InfiniiMode capable.

Auto-Selected Input Attenuation Ranges

More attenuation ranges give you superior noise performance and larger voltage ranges all while maintaining maximum bandwidth. With auto-selected input attenuation ranges, the input range is automatically configured depending on the size of the input signal and the vertical scale of the scope.

True View and Source Estimate Probe Response Correction Modes

You can choose whether you want your probe to show you the voltage at the tip of probe (V_{out}/V_{in} - True View) as loaded by the probe or the estimate of the voltage at the probe point before the probe load was applied (V_{out}/V_{source} - Source Estimate).

Some helpful definitions:

- V_{source} - The signal at the probe point "before" the probe is connected which would be the signal at the probe point if an ideal probe with infinite input impedance were connected.
- V_{in} - The signal at the probe point while the signal is being loaded by the probe. Probe loading is caused by the input impedance of the probe making a voltage divider with the source impedance of the circuit being measured.
- V_{out} - The signal that is output from the probe or the signal that is shown on the scope screen.
- Source impedance - The impedance of the circuit that is driving the probe, which is the impedance looking back to the point being probed with the probe connected.

	True View	Source Estimate
Pros	The signal at the output of the probe is an accurate representation of the signal that currently exists, as it is being probed. Best to use for receiver sensitivity because you have to measure what is actually there. Doesn't hide the fact that the probe loaded the signal.	When system source impedance is known, it more accurately depicts the signal before it was probed. Best to use for transmitter test because it is best at estimating the signal coming out of the transmitter.
Cons	Doesn't estimate signal that was there before being probed. Signal at the probe point is loaded at the probe.	Error in receiver type testing because doesn't show the signal that is actually there while being probed Hides the effect that probe loading has on the signal being probed.

Probe Specific DSP Correction

When an InfiniiMax probe is connected to a scope channel and the proper probe head is selected, the scope calculates a DSP correction filter that includes the probe head, probe amplifier, and scope channel. This provides the maximum measurement accuracy for the complete probe and scope channel system. Some InfiniiMax probes store unique S parameters in on board memory for the scope to read out when the probe amp is connected to the scope. Unique S-parameters, as opposed to nominal, means each individual probe amp contains its own frequency response data to further flatten the magnitude and phase response of the probe for high accuracy measurements. Nominal S-parameters mean that s-parameters are standard across all probe models but are still used in the DSP correction algorithms.

Extreme Temperature Probing

InfiniiMax probes offer wide operating temperatures ranges with the appropriate probe head, making them ideal for environmental chamber testing with the probe head soldered to the DUT inside the chamber. The MX0100A 25 GHz micro probe head and the MX0109A 26 GHz solder-in probe head are both rated for a range of -55 to +150 °C as per JEDEC JESD22-A104 revision E spec.

InfiniiMax Probe Heads and Accessories

Keysight's InfiniiMax probing system supports a wide variety of high-speed probing applications with an extensive line-up of probe heads and accessories. Most InfiniiMax probe heads and accessories are split up into 2 groups based on input impedance architecture: RC architecture (Gen I, II, RC, and Ultra) and RCRC architecture (Gen III and III+). RC probe heads are only compatible with RC probe amplifiers; likewise, RCRC probe heads are only compatible with RCRC probe amplifiers.

InfiniiMax RC Architecture Probe Heads and Accessories

The following table lists all compatible RC probe heads and accessories. These are compatible with InfiniiMax Gen I/II/RC/Ultra probe amplifiers except where noted.

Model	Bandwidth	Description
E2655C	13 GHz	Probe deskew and performance verification kit ³
E2668B	N/A	InfiniiMax I connectivity kit for single-ended measurements (E2676B/77B/78B) ³
E2669B	N/A	InfiniiMax I connectivity kit for diff/single-ended measurements (E2675B/77B/78B)
E2675B	6 GHz	Differential browser head
E2676B	6 GHz	Single-ended browser probe head ³
E2677B	12 GHz	Differential solder-in head
E2678B	12 GHz	Differential/single-ended socketed probe head
E2679B	6 GHz	Single-ended solder-in probe head ³
MX0100A-001	25 GHz	Micro probe head (set of 5), supports InfiniiMode
MX0100A-002	25 GHz	Micro probe head (set of 25), supports InfiniiMode
MX0100A-003	25 GHz	Micro probe head (set of 50), supports InfiniiMode
MX0102A	N/A	Soldering Tool Kit
MX0103A	25 GHz	Bullet adapter
MX0104A	40 GHz	Performance verification and deskew fixture ^{1,2}
MX0105A	21 GHz	SMA probe head, supports InfiniiMode
MX0106A	23 GHz	Solder-in probe head, supports InfiniiMode
N2787A	N/A	3D probe positioner
N2823A	40 GHz	2.92 mm phase-matched cable pair (1 m)
N2833A	N/A	InfiniiMax II differential connectivity kit (N2839A, N5381B, N5425B/26A, N2851A/49A) ¹
N2837A	21 GHz	Browser head replace tip kit (set of 40) ¹
N2839A	21 GHz	Browser head ¹
N2849A	13 GHz	QuickTip probe head tips ³
N2851A	13 GHz	QuickTip probe head ³
N2852A	N/A	AutoProbe II to AutoProbe III interface adapter (for use with UXR 1- and 1.85-mm models)
N2880A	N/A	Coaxial attenuator Kit (pairs of 6, 12, and 20 dB attenuators)
N2881A	N/A	DC blocking caps (set of 2 30-VDC block caps)
N2884A	12 GHz	ZIF fine wire tips for wafer probing
N2887B	4 GHz	Soft touch pro probe interface adapter ³
N2888A	4 GHz	soft touch half-channel probe interface adapter ³
N5380B	12 GHz	SMA probe head
N5381B	12 GHz	Solder-in probe head
N5425B	18 GHz	ZIF probe head
N5426A	18 GHz	ZIF tip (set of 10)
N5442A	N/A	AutoProbe I to AutoProbe II interface adapter (3.5 mm to precision BNC adapter)
N5448B	40 GHz	2.92 mm phase-matched cable pair (25 cm)
N5450B	N/A	Extreme temperature extension cable, 1 m long
N5451A	5 & 9.9 GHz	Long-wired ZIF tip kit (7 and 11 mm)

1. NOT compatible with Gen I.
2. NOT compatible with Gen II.
3. NOT compatible with Gen RC.

InfiniiMax RCRC Architecture Probe Heads and Accessories

The following table lists compatible RCRC probe heads and accessories. These are compatible with InfiniiMax Gen III/III+ probe amplifiers except where noted.

Model	Bandwidth	Description
E2655C	13 GHz	Performance verification and deskew fixture
MX0104A	40 GHz	Performance verification and deskew fixture
MX0109A	26 GHz	Extreme temperature solder-in head, supports InfiniiMode
N2787A	N/A	3D probe positioner
N2812A	N/A	High performance input cable, 2.92 mm connectors, 1 m length
N2823A	40 GHz	2.92 mm phase-matched cable pair (1 m)
N2835A	N/A	InfiniiMax III/III+ differential connectivity kit (N5439A/45A, N2836A/38A/48A/49A)
N2838-68701	N/A	10x 130-ohm resistors for tip resistor replacement
N2838A	25 GHz	450-ohm PCB ZIF tips (set of five)
N2848A	16 GHz	QuickTip probe head, supports InfiniiMode
N2849A	16 GHz	QuickTip tips (set of 4)
N2852A	N/A	AutoProbe II to AutoProbe III interface adapter
N5381B	12 GHz	Wire tips
N5439A	28 GHz	ZIF probe head
N5440A	28 GHz	450-ohm ceramic ZIF tip kit (set of five)
N5442A	N/A	3.5 mm to precision BNC adapter
N5444A	30 GHz	3.5/2.92 SMA probe head, supports InfiniiMode
N5445A	30 GHz	Differential browser probe head
N5447A	28 GHz	200-ohm ceramic ZIF tip kit (set of five)
N5448B	40 GHz	2.92 mm phase-matched cable pair (25cm)
N5449A	N/A	High impedance probe adapter, include one N2878A 500 MHz 10:1 passive probe
N5450B	N/A	Extreme temperature extension cable, 1 m long
N5476A	30 GHz	Browser tip replacement (set of 4)
N5477A	N/A	Sampling scope adapter ¹

1. NOT compatible with Gen III+.

InfiniiMax Ultra Series

The latest series of InfiniiMax probes for high speed digital designers. They are the most accurate and easiest to use.

Ultra Performance

- Lowest noise to see your signal more clearly
- More breadth with 5 models ranging from 10 to 25 GHz of bandwidth
- Highest input impedance in midband frequencies, crucial for probing high impedance nodes

Ultra Accuracy

- Highest accuracy across the widest frequency range to see the truest representation of your signal
- Lowest loading for least impact to your circuit
- Boost test margins with the least signal distortion from your probe

Ultra Usability

- Easily probe small devices with the super flexible micro probe head
- Compatible with your existing probe heads and accessories
- Measure differential, single-ended, and common mode signals with a single probe tip

Model	Bandwidth	Description
MX0020A	10 GHz	InfiniiMax Ultra probe amplifier, AutoProbe 2 interface
MX0021A	13 GHz	InfiniiMax Ultra probe amplifier, AutoProbe 2 interface
MX0022A	16 GHz	InfiniiMax Ultra probe amplifier, AutoProbe 2 interface
MX0024A	20 GHz	InfiniiMax Ultra probe amplifier, AutoProbe 2 interface
MX0025A	25 GHz	InfiniiMax Ultra probe amplifier, AutoProbe 2 interface

InfiniiMax Ultra Probe Amplifier Characteristics

These are characteristics that are mainly determined by the probe amplifier.

	With 25 k Ω probe heads	With MX0105A SMA probe head
DC input resistance	Rse = 25 k Ω \pm 2% each input to ground, Rdiff = 50 k Ω \pm 2%	50 Ω (to V _{term})
Maximum input power	N/A	100 mW or 2.28 V _{rms} (V _{in} -V _{cm_term}) into 50 Ω
Input voltage range (differential or single-ended)	0.6 V _{pp} , \pm 0.3 V @ 1:1	0.38 V _{pp} , \pm 0.19 V @ 1:1.56
	2.5 V _{pp} , \pm 1.25 V @ 4:1	1.54 V _{pp} , \pm 0.77 V @ 2.57:1
	5.0 V _{pp} , \pm 2.5 V @ 7.6:1	3.2 V _{pp} , \pm 1.6 V @ 4.87:1
Input common mode range	\pm 8 V (DC to 100 Hz)	\pm (4.3 V – V _{cm_term} x 0.29) (DC to 100 Hz)
	\pm 0.5 V @ 1:1, \pm 4 V @ 4:1 (> 100 Hz)	\pm 0.19 V @ 1:1.57, \pm 0.77 V @ 2.57:1 (> 100 Hz)
Maximum signal slew rate	25 V/ns when probing a SE signal	16 V/ns when probing a SE signal
	40 V/ns when probing a differential signal	26 V/ns when probing a differential signal
DC attenuation ratio	1:1, 4:1, or 7.6:1 automatically selected based on volts/division setting	1:1.56, 2.57:1, or 4.87:1 automatically selected based on volts/division setting
Offset range (for probing a single-ended signal)	\pm 16 V	
Offset accuracy	< 3 %	
Zero offset error referred to input	< 2 mV x DC attenuation	< 2 mV
Input referred noise, in spectral density	25.0 nV/ $\sqrt{\text{Hz}}$ @ 1:1	16.0 nV/ $\sqrt{\text{Hz}}$ @ 1:1.56
	39.7 nV/ $\sqrt{\text{Hz}}$ @ 4:1	25.5 nV/ $\sqrt{\text{Hz}}$ @ 2.57:1
	45.0 nV/ $\sqrt{\text{Hz}}$ @ 7.6:1	29.0 nV/ $\sqrt{\text{Hz}}$ @ 4.87:1
Input referred noise, in mV _{rms}	3.95 mV _{rms} @ 1:1 and 25 GHz	2.26 mV _{rms} @ 1:1.56 and 20 GHz
	6.28 mV _{rms} @ 4:1 and 25 GHz	3.61 mV _{rms} @ 2.57:1 and 20 GHz
	7.10 mV _{rms} @ 7.6 and 25 GHz	4.55 mV _{rms} @ 4.87:1 and 20 GHz
Propagation delay	~6.1 nsec	~6.1 nsec
Maximum non- destructive input voltage	30 V peak (mains isolated)	
Probe interface	AutoProbe II interface – direct connection to Infiniium 90000X, V, Z, Q, UXR (3.5 mm models), requires N2852A adapter with UXR (1 and 1.85 mm models)	
Oscilloscope compatibility	Infiniium UXR, 90000X, V, Z, Q series with software	
	<ul style="list-style-type: none"> Ver 6.70 or later (for 90000X, V, Z, Q models) Ver 11.20 or later (for UXR models) 	

For more information on the InfiniiMax Ultra Series, please see the following datasheet and user guide.

- [InfiniiMax Ultra User Guide](#)
- [InfiniiMax Ultra Data Sheet](#)



InfiniiMax RC Probe

Key features

- 25 GHz bandwidth with an RC input impedance topology for low mid-band probe loading
- Enabling today's emerging signaling standards including: LPDDR/DDR5, MIPI bus signaling and other high-speed signal debug and validation test needs
- Probe amp specific S parameter correction filter enabling high accuracy measurements
- Auto-switchable 1:1 and 4:1 attenuation ratio at full 25 GHz bandwidth
- Support for Keysight's broad variety of probe heads and InfiniiMax I/II accessories
- AutoProbe II interface for easy direct connection to Keysight's Infiniium Series Oscilloscopes

Scope compatibility

See the table on page 3.

Keysight's new MX0023A InfiniiMax RC probe provides high bandwidth and low loading, offering up to 25 GHz bandwidth and an RC input impedance profile for extremely low mid-band loading, which is necessary to address modern high-speed probing requirements. It also provides a wide variety of flexible connectivity solution, covering today's emerging signaling standards such as DDR5/LPDDR5 and other high-speed signal debug and validation test needs.



Characteristics performance plots: MX0023A 25 GHz probe amp with MX0100A micro probe head

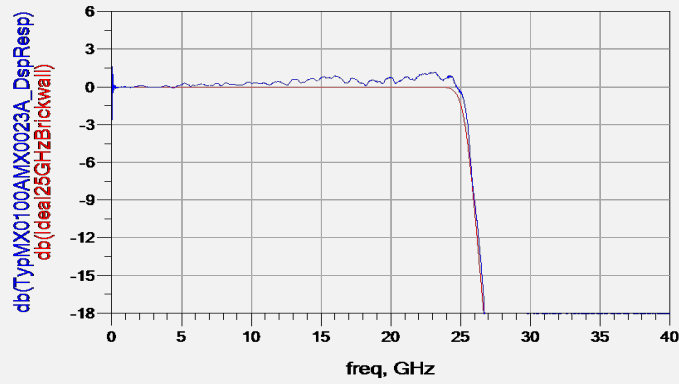

Frequency response of an ideal 25 GHz brickwall filter (red) and the typical DSP corrected probe response filtered by the brickwall filter (blue).

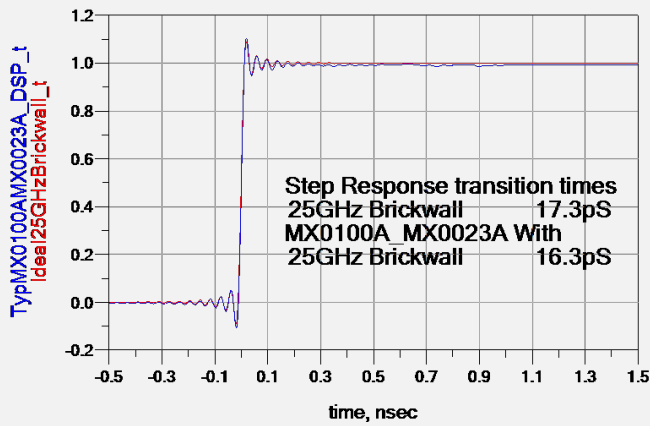

Time domain step responses for the two responses

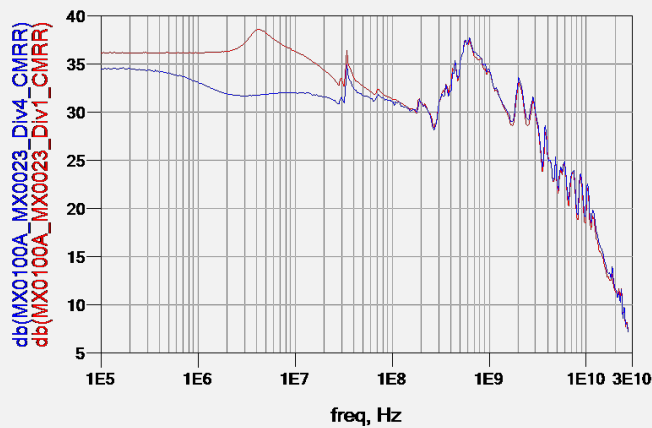

CMRR for the 1:1 (red) and 4:1 (blue) mode.

InfiniiMax RC probing system family diagram

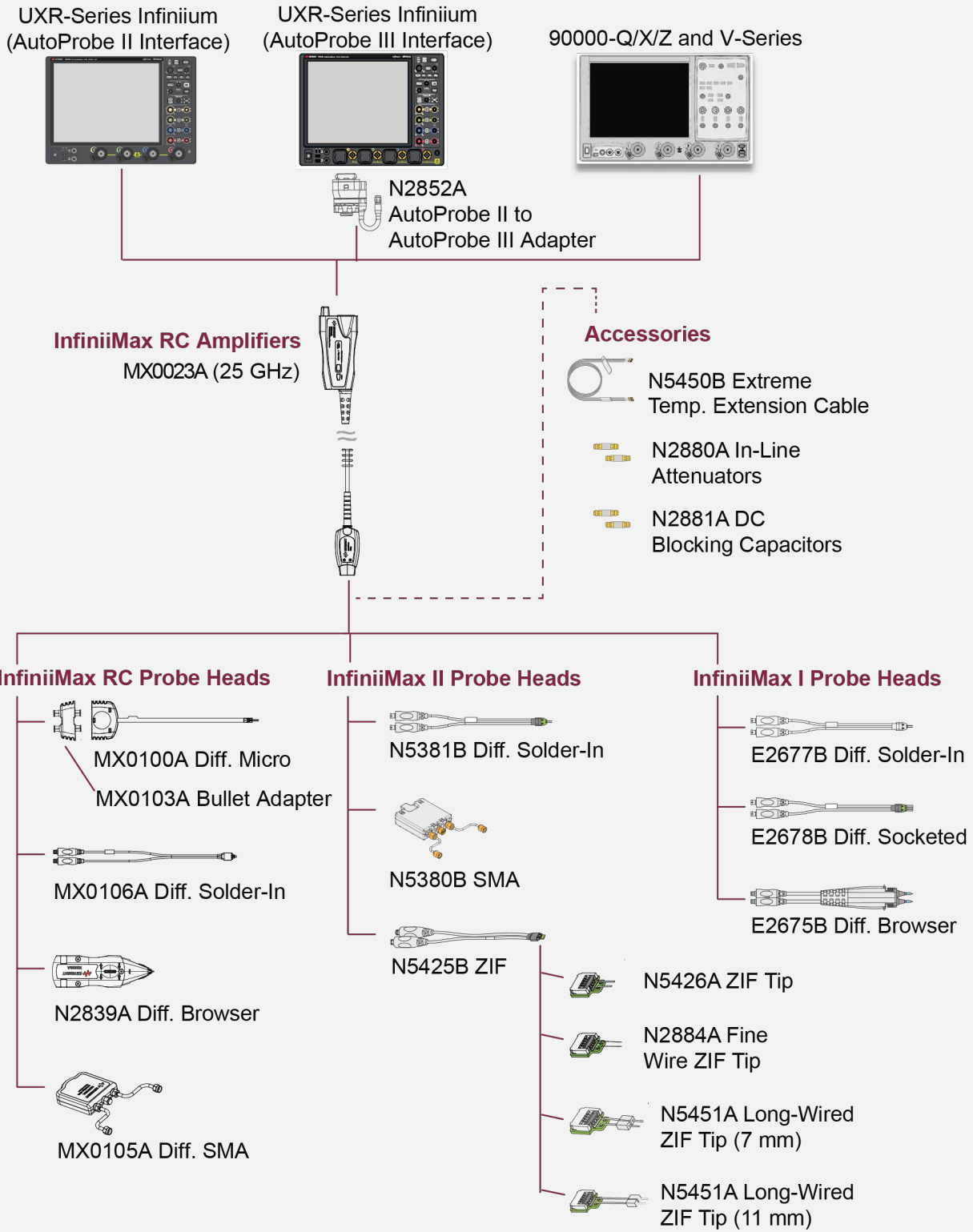

Characteristics (of MX0023A with each probe head)

Key specifications	Probe amp	Bandwidth	DC input resistance
MX0100A Micro probe head (with 60 mil leads)	MX0023A	25 GHz	Rdiff = 50 kΩ ± 2%
			Rse = 25 kΩ ± 2%

InfiniiMax RC probe head characteristics

- These are characteristics that are mainly determined by the probe head.
- Bandwidth and rise time numbers listed are: -3 dB bandwidth/10-90% transition time/20-80% transition time.
- Performance listed below is with the MX0023A probe amp.
- Refer to the MX0023A user's guide for more details.

Characteristics (of MX0023A with each probe head)

Probe heads	Input capacitance DC input resistance	Bandwidth and rise time (AmpBW/(.435/AmpBW)/ (.308/AmpBW))
MX0100A micro probe head (with 60 mil leads)	Cdiff=170 fF; Cse=260 fF	25 GHz/17.4 pS/12.3 pS
	Rdiff=50 kΩ; Rse=25 kΩ	
MX0100A micro probe head (with 135 mil leads)	Cdiff= 170 fF, Cse=260 fF	12 GHz/36.3 pS/25.7 pS
	Rdiff=50 kΩ, Rse=25 kΩ	
MX0106A solder-in probe head	Cdiff=170 fF; Cse=290 fF	23 GHz/18.9 pS/13.4 pS
	Rdiff=50 kΩ; Rse=25 kΩ	
N2839A browser	Cdiff=205 fF; Cse=340 fF	21 GHz/20.7 pS/14.7 pS
	Rdiff=50 kΩ; Rse=25 kΩ	
MX0105A SMA probe head	N/A	21 GHz/21.8 pS/15.4 pS
	50 Ω to V _{term}	
N5425B ZIF head with N5426A ZIF tip	Cdiff=330 fF; Cse=530 fF	18 GHz/24.1 pS/17.1 pS
	Rdiff=50 kΩ; Rse=25 kΩ	
N5380B SMA head	N/A	12 GHz/36.3 pS/25.7 pS
	50 Ω to V _{term}	
N5381B solder-in head	Cdiff=210 fF; Cse=350 fF	12 GHz/36.3 pS/25.7 pS
	Rdiff=50 kΩ; Rse=25 kΩ	

InfiniiMax RC probe amp characteristics

These are characteristics that are mainly determined by the probe amp.

	With 25 k Ω probe heads	With MX0105A SMA probe head
DC input resistance	Rse = 25 k Ω \pm 2% each input to ground, Rdiff = 50 k Ω \pm 2%	50 Ω (to V _{term})
Maximum input power	N/A	100 mW or 2.28 V _{rms} (V _{in} -V _{cm_term}) into 50 Ω
Input voltage range (differential or single-ended)	0.6 V _{pp} , \pm 0.3 V (at 1:1)	0.38 V _{pp} , \pm 0.19 V (at 1:1.56)
	2.5 V _{pp} , \pm 1.25 V (at 4:1)	1.54 V _{pp} , \pm 0.77 V (at 2.57:1)
Input common mode range	\pm 8 V (DC to 100 Hz)	\pm (4.3 V – V _{cm_term} x 0.29) (DC to 100 Hz)
	\pm 0.5 V at 1:1, \pm 4 V at 4:1 (> 100 Hz)	\pm 0.19 V at 1:1.57, \pm 0.77 V at 2.57:1 (> 100 Hz)
Maximum signal slew rate	25 V/ns when probing a SE signal	16 V/ns when probing a SE signal
	40 V/ns when probing a differential signal	26 V/ns when probing a differential signal
DC attenuation ratio	1:1 or 4:1, automatically selected based on volts/division setting	1:1.56 or 2.57:1 automatically selected based on volts/division setting
Offset range (for probing a single-ended signal)	\pm 16 V	
Offset accuracy	< 3 %	
Zero offset error referred to input	< 2 mV x DC attenuation	< 2 mV
Input referred noise, in spectral density	25.0 nV/ $\sqrt{\text{Hz}}$ at 1:1	16 nV/ $\sqrt{\text{Hz}}$ at 1:1.56
	39.7 nV/ $\sqrt{\text{Hz}}$ at 4:1	25.5 nV/ $\sqrt{\text{Hz}}$ at 2.57:1
Input referred noise, in mV _{rms}	3.95 mV _{rms} at 1:1 and 25 GHz	2.26 mV _{rms} at 1:1.56 and 20 GHz
	6.28 mV _{rms} at 4:1 and 25 GHz	3.61 mV _{rms} at 2.57:1 and 20 GHz
Propagation delay	~6.1 nsec	~6.1 nsec
Maximum non-destructive input voltage	30 V peak (mains isolated)	
Probe interface	AutoProbe II interface – direct connection to Infiniium 90000X, V, Z, Q, UXR \leq 33 GHz models, requires N2852A with UXR \geq 40 GHz models	
Oscilloscope compatibility	Infiniium UXR, 90000X, V, Z, Q series with software	
	<ul style="list-style-type: none"> • Ver 6.55 or later (for 90000X, V, Z, Q models) • Ver 10.25 or later (for UXR models) 	

InfiniiMax Gen III/III+ Probes

Key features

- Full 30 GHz bandwidth to the probe tip
- InfiniiMode probing for making differential, single-ended and common mode measurements with a single probe (InfiniiMax III+)
- Industry's highest fidelity and accuracy due to bandwidth and extremely low loading
- Probe amplifiers loaded with measured S-parameters for more accurate response correction
- Bandwidth upgradeable (InfiniiMax III only)
- Variety of probe heads for different use models with maximum usability

Scope compatibility

See the table on page 3.

The InfiniiMax III/III+ probing system provides the highest performance and low loading to allow for a completely new level of signal fidelity and accuracy. Eleven different InfiniiMax III/III+ probe amplifiers ranging from 4 to 30 GHz are available for matching your probing solution to your performance and budget requirements. The InfiniiMax III+ probing system is the next generation of InfiniiMax probing. It greatly expands the measurement capability and usability of probes capable of measuring all components of a differential signal with the built-in InfiniiMode technology.

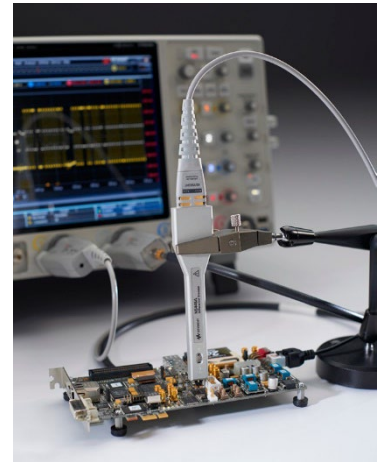

InfiniiMax III amp with ZIF head/tips

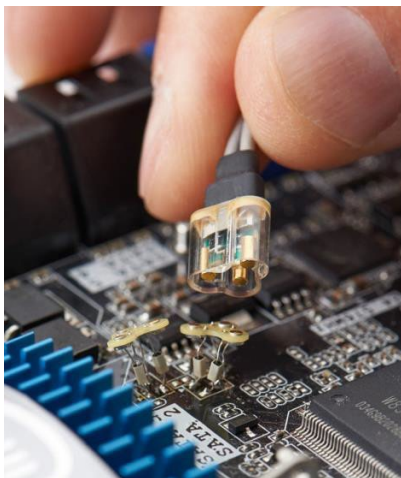

QuickTip head and tip

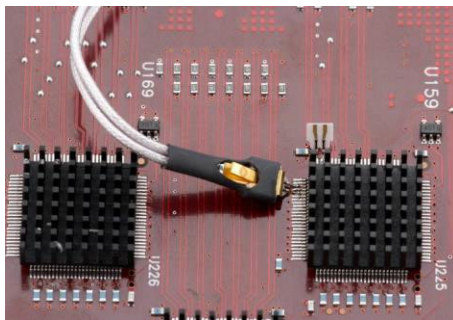

InfiniiMax III amp with ZIF head/tips



N2830A InfiniiMax III+ amp with QuickTiphead

Characteristics performance plots: N2803A 30-GHz probe amp with N5445A 30-GHz browser

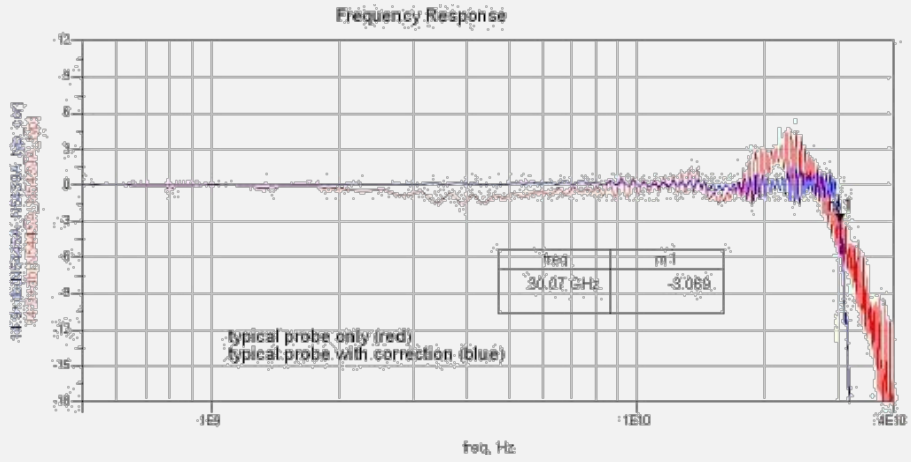

Frequency response plot with 1 mm span

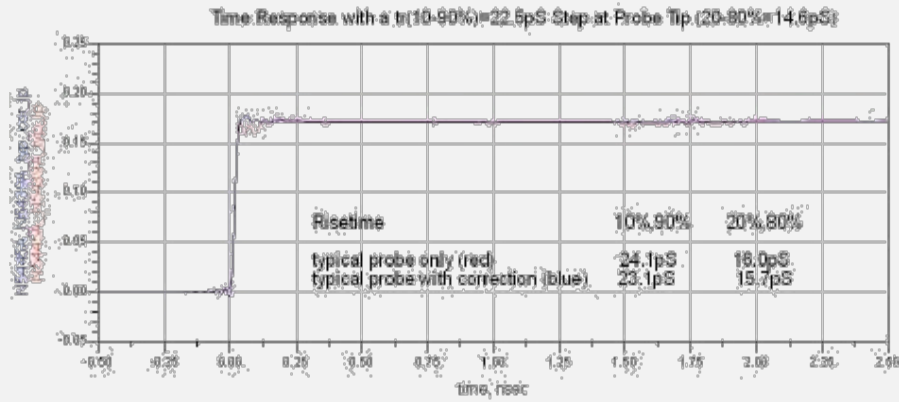



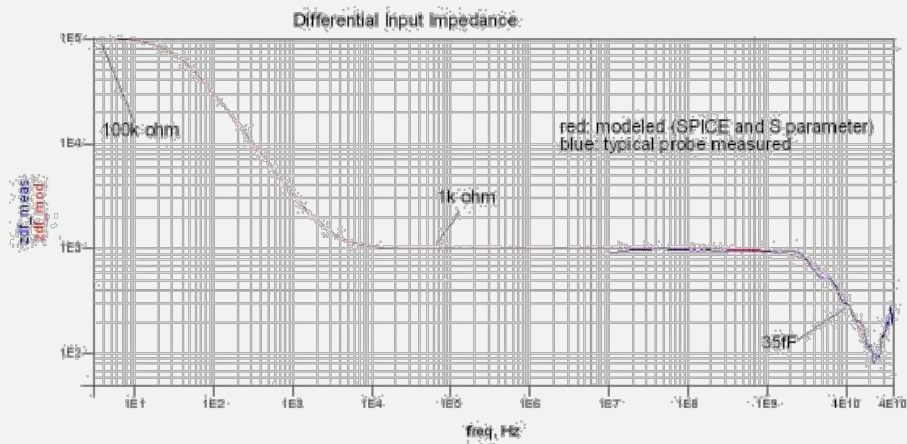

Time domain response plot with 1 mm span



Differential input impedance

InfiniiMax III/III+ probe heads

InfiniiMax III/III+ probe heads are recommended for InfiniiMax III N2801A/02A/03A, and InfiniiMax III+ N2830A/31A/32A and N7000A/01A/02A/03A probe amplifiers. Any probe heads for InfiniiMax I or II are not compatible with InfiniiMax III or III+ amplifier and vice versa.

Probe heads	Model numbers	BW and input loading	Key features
Differential browser head 	N5445A	30 GHz, $C_{diff} = 35 \text{ fF}$, $C_{se} = 50 \text{ fF}$, $R_{diff} = 100 \text{ k}\Omega$, $R_{se} = 50 \text{ k}\Omega$	Z axis compliance and variable spacing from 20 mil to 125 mils, integrated LED lighting
ZIF probe head/tips 	N5439A head, N2838A 450 Ω PCB tip, N5440A 450 Ω ceramic tip, N5447A 200 Ω ceramic tip	28 GHz, $C_{diff} = 95 \text{ fF}$, $C_{se} = 130 \text{ fF}$, with N2838A: $C_{diff} = 32 \text{ fF}$, $C_{se} = 44 \text{ fF}$, with N5440A: $R_{diff} = 100 \text{ k}\Omega$, $R_{se} = 50 \text{ k}\Omega$ N5447A: $R_{diff} = 50 \text{ k}\Omega$, $R_{se} = 25 \text{ k}\Omega$ with N5440A/N2838A	Extremely low loading, Variable spacing from 5 mil to 80 mil. User replaceable damping resistor tips (N2838A only)
2.92 mm/3.5 mm/ SMA probe head 	N5444A	30 GHz, N/A, 55 Ω to V_{term}	Provides termination voltage of $\pm 4 \text{ V}$ controlled by scope or externally. Supports InfiniiMode with InfiniiMax III+ amp
Extreme temperature solder-in head 	MX0109A	26 GHz, $C_{diff} = 108 \text{ fF}$, $C_{se} = 140 \text{ fF}$, $R_{diff} = 100 \text{ k}\Omega$, $R_{se} = 50 \text{ k}\Omega$	For solder-in connection, variable span of leads ranges from 5 to 250 mil, user replaceable damping resistor tips. Supports extreme operating temperature of -55 to $+150 \text{ }^\circ\text{C}$ per JEDEC JESD22-A104 revision E. Form, fit, function compatible with N2836A. Supports InfiniiMode with InfiniiMax III+ amp.
Solder-in head 	N2836A	26 GHz, $C_{diff} = 108 \text{ fF}$, $C_{se} = 140 \text{ fF}$, $R_{diff} = 100 \text{ k}\Omega$, $R_{se} = 50 \text{ k}\Omega$	Economical and semi-permanent connection, variable span of leads ranges from 5 to 80 mil, user replaceable damping resistor tips. N2836A supports InfiniiMode with InfiniiMax III+ amp. N2836A replaced the N5441A. N2836A has -40 to $+85 \text{ }^\circ\text{C}$ of operating temperature range.
Quick tip 	N2848 QuickTip head for InfiniiMax III/III+, N2849A QuickTip tips	16 GHz (with InfiniiMax III/III+), 13 GHz (with InfiniiMax II), $C_{diff} = 340 \text{ fF}$, $C_{se} = 200 \text{ fF}$	Magnetically-engaged probe head and tip for quick and secure connection, compatible with I/II/III/III+ amp. Supports InfiniiMode with InfiniiMax III+ amp. For using QuickTip with InfiniiMax I/II amp, choose the N2851A QuickTip head for InfiniiMax I/II and N2849A QuickTip tips.

InfiniiMax III/III+ probing system family diagram

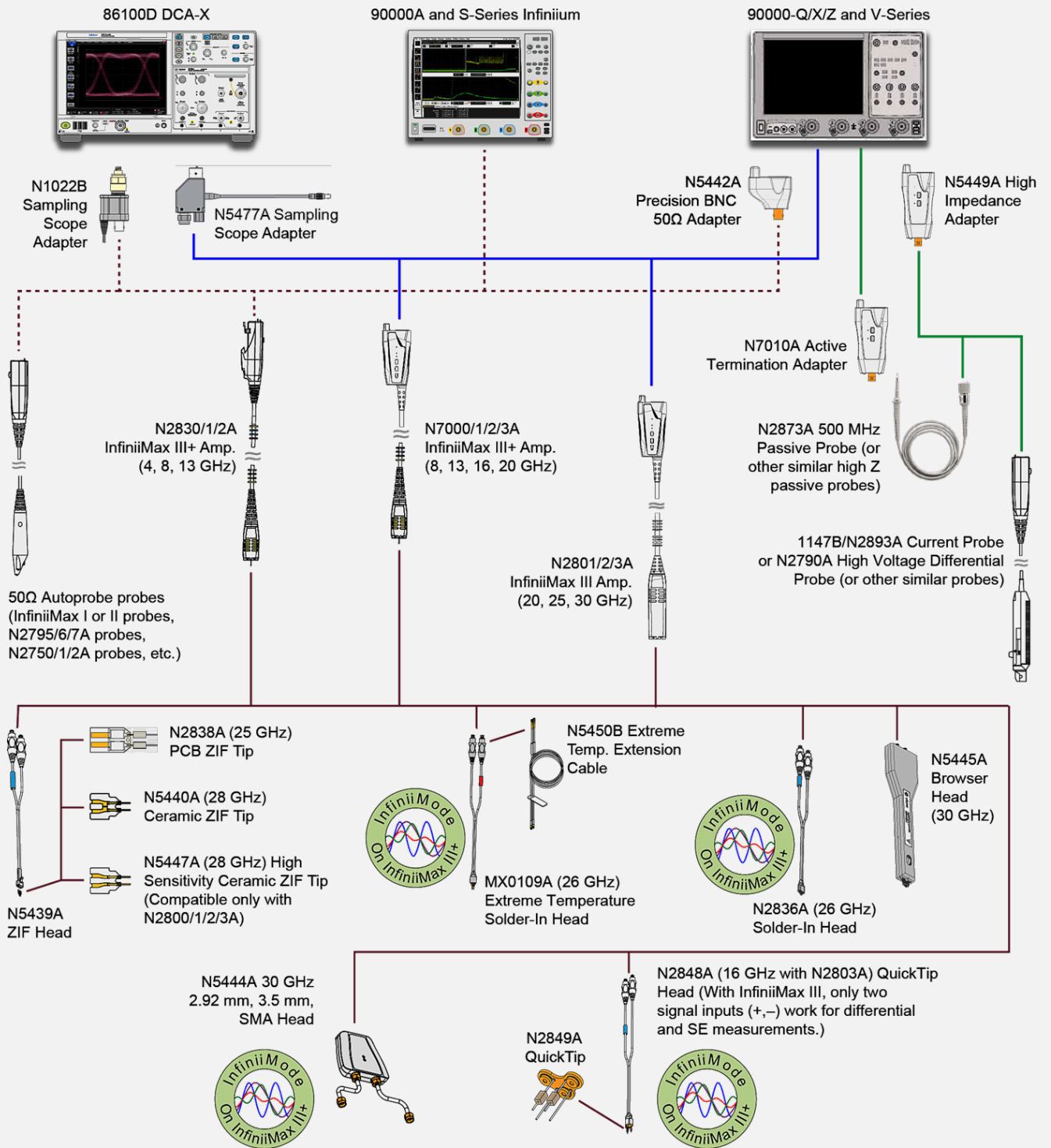

InfiniiMax III/III+ warranted specifications

Probe head	Probe amp	Bandwidth	DC input
N5440A_N5439A ceramic 450 Ω ZIF tip and ZIF probe head	N2803A 30 GHz probe amp	26 GHz	Rdiff = 100 kΩ ± 2%
			Rse = 50 kΩ ± 2%
N5445A 450 Ω browser	N2803A 30 GHz probe amp	28 GHz	Rdiff = 100 kΩ ± 2%
			Rse = 50 kΩ ± 2%
MX0109A/N2836A 450 Ω solder-in probe head vertical orientation with no ground wires	Differential mode N7003A 20 GHz probe amp	20 GHz	Rdiff = 100 kΩ ± 2%
			Rse = 50 kΩ ± 2%

InfiniiMax III/III+ probe head characteristics

These characteristics are mainly determined by the probe head. Performance numbers listed are: –3 dB bandwidth/10 to 90% transition time/20 to 80% transition time. Performance listed is with the highest bandwidth probe amp models in each family. Performance with lower bandwidth amps is the lower of the: AmpBW, (0.434/AmpBW), (0.308/AmpBW), or bandwidth measured with the highest bandwidth amp in the family.

Probe head	Input C	InfiniiMax III N2803A 30-GHz probe amp	InfiniiMax III+ N7003A 20-GHz probe amp		Common mode
		Differential mode	Differential mode	Single- ended mode	
N5440A_N5439A ceramic 450 Ω ZIF tip and ZIF probe head	Cdiff = 32 fF; Cse = 44 fF	28 GHz, 15.5 pS, 11.0 pS	20 GHz, 21.7 pS, 15.4 pS	N/A	
N5447A_N5439A ceramic 200 Ω ZIF tip and ZIF probe head	Cdiff = 32 fF; Cse = 44 fF	28 GHz, 15.5 pS, 11.0 pS	N/A		
N5445A 450 Ω browser	Cdiff = 35 fF; Cse = 50 fF	30 GHz, 14.5 pS, 10.3 pS	20 GHz, 21.7 pS, 15.4 pS	N/A	
N2838A_N5439A PC board 450 Ω ZIF tip and ZIF probe head	Cdiff = 95 fF; Cse = 130 fF	25 GHz, 17.4 pS, 12.3 pS	20 GHz, 21.7 pS, 15.4 pS	N/A	
MX0109A/N2836A 450 Ω solder-in probe head vertical orientation with no ground wires	Cdiff = 108 fF; Cse = 140 fF	27 GHz, 16.1 pS, 11.4 pS	20 GHz, 21.7 pS, 15.4 pS	N/A	
MX0109A/N2836A 450 Ω solder-in probe head flat orientation with minimum length ground wires	Cdiff = 108 fF; Cse = 140 fF	27 GHz, 16.1 pS, 11.4 pS	Differential: 20 GHz, 21.7 pS, 15.4 pS Single-ended: 20 GHz, 21.7 pS, 15.4 pS Common mode: 20 GHz, 21.7 pS, 15.4 pS		

N2849A_N2848A 450 Ω QuickTip and QuickTip probe head with ground wires connected	C _{diff} = 200 fF; C _s = 340 fF	16 GHz, 27.1 pS, 19.3 pS	Differential: 20 GHz, 21.7 pS, 15.4 pS Single-ended: 13 GHz, 33.4 pS, 23.7 pS Common mode: 13 GHz, 33.4 pS, 23.7 pS	
N5444A 2.92 mm, SMA, 3.5 mm probe head	N/A	30 GHz, 15.5 pS, 11.0 pS	Differential: 20 GHz, 21.7 pS, 15.4 pS Single-ended: 20 GHz, 21.7 pS, 15.4 pS Common mode: 20 GHz, 21.7 pS, 15.4 pS	

InfiniiMax III/III+ probe amp characteristics

These characteristics are mainly determined by the probe amp.

N280XA InfiniiMax III probe amp			N700xA InfiniiMax III+ probe amp		
Features	450 Ω probe heads	200 Ω probe heads	N5444A 2.92 mm, SMA, 3.5 mm probe head	450 Ω probe heads	N5444A 2.92 mm, SMA, 3.5 mm probe head
DC input resistance	R _{se} = 50 kΩ ± 2% each input to ground, R _{diff} = 100 kΩ ± 2% and R _{cm} = 25 kΩ ± 2%	R _{se} = 50 kΩ ± 2% each input to ground, R _{diff} = 100 kΩ ± 2% and R _{cm} = 25 kΩ ± 2%	55 Ω to V _{term}	R _{se} = 50 kΩ ± 2% each input to ground, R _{diff} = 100 kΩ ± 2% and R _{cm} = 25 kΩ ± 2%	55 Ω to V _{term}
Input resistance > 10 kHz	R _{se} = 500 Ω each input to ground, R _{diff} = 1 kΩ and R _{cm} = 250 Ω	R _{se} = 250 Ω each input to ground, R _{diff} = 1 kΩ and R _{cm} = 250 Ω	50 Ω to 0.901*V _{term}	R _{se} = 500 Ω each input to ground, R _{diff} = 1 kΩ and R _{cm} = 250 Ω	50 Ω to 0.901*V _{term}
Input voltage range (differential or single-ended)	1.6 V _{pp} , ± 0.8 V (HD2&3 < -38 dbc), 2.5 V _{pp} , ± 1.25 V (HD2&3 < -34 dbc)	0.8 V _{pp} , ± 0.4 V (HD2&3 < -38 dbc), 1.6 V _{pp} , ± 0.8 V (HD2&3 < -34 dbc)	1.6 V _{pp} , ± 0.8 V (HD2&3 < -38 dbc), 2.5 V _{pp} , ± 1.25 V (HD2&3 < -34 dbc)	2.5 V _{pp} or ± 1.25 V at 5:1 attenuation, 5.0 V _{pp} or ± 2.50 V at 10:1 attenuation	2.5 V _{pp} or ± 1.25 V at 5:1 attenuation, 5.0 V _{pp} or ± 2.50 V at 10:1 attenuation without violating max input power
Max input power	N/A	N/A	125 mW calculated by $\{[\text{rms}(\text{vin}-\text{V}_{\text{term}})]^2/55\}$ for each input	N/A	125 mW calculated by $\{[\text{rms}(\text{vin}-\text{V}_{\text{term}})]^2/55\}$ for each input

Input common mode range	± 12 VDC to 250 Hz, ± 1.25 V > 250 Hz	± 6 VDC to 250 Hz, ± 0.65 V > 250 Hz	± 6 VDC to 250 Hz, ± 1.25 V > 250 Hz without violating max input power	± 7 VDC to 100 Hz, ± 1.25 V > 100 Hz at 5:1 attenuation, ± 2.5 V > 100 Hz at 10:1 attenuation	± 6 VDC to 100 Hz, ± 1.25 V > 100 Hz at 5:1 attenuation, ± 2.5 V > 100 Hz at 10:1 Attenuation without violating max input power
DC attenuation ratio	6:1	3:1	6:1	5:1 or 10:1 Automatically selected based on volts/division (all modes)	5:1 or 10:1 Automatically selected based on volts/division (all modes)
Offset range (for probing a single-ended signal)	± 16 V	± 8 V	± 6 V without violating max input power	± 16 V	± 6 V without violating max input power
Input referred noise spectral density	23.9 nV/rt (Hz)	12.0 nV/rt (Hz)	23.9 nV/rt (Hz)	Diff 5:1 atten 33.5 nV/rt(Hz), Diff 10:1 atten 53.9 nV/rt(Hz), SE A or B 5:1 atten 27.8 nV/rt(Hz), SE A or B 10:1 atten 47.7 nV/rt(Hz), CM 5:1 atten 21.8 nV/rt(Hz), CM 10:1 atten 38.4 nV/rt(Hz)	
Input referred noise example	4 mVrms with 28 GHz probe head and 30 GHz probe amp	2 mVrms with 28 GHz probe head and 30 GHz probe amp	4 mVrms	4.5 mVrms in diff mode 5:1 atten with ≥ 18 GHz probe head and 13 GHz probe amp	4.5 mVrms in diff mode 5:1 atten with 30 GHz N5444A probe head and 13 GHz probe amp
Maximum input voltage	18 Vpeak mains isolated	18 Vpeak mains isolated	8 Vpeak without violating max input power	18 Vpeak mains isolated	8 Vpeak without violating max input power

Ordering information

InfiniiMax III/III+ probe amplifier models

Model number	Description	Recommended oscilloscope
N2803A	30 GHz InfiniiMax III probe amplifier	Infiniium UXR (3.5 mm models), V, Z, Q, and 90000X Series, UXR (1 mm and 1.85 mm models) with N2852A adapter, N1000A and 86100D DCA-X with N5477A adapter (only for N2801A/02A/03A)
N2802A	25 GHz InfiniiMax III probe amplifier	
N2801A	20 GHz InfiniiMax III probe amplifier	
N7003A	20 GHz InfiniiMax III+ probe amplifier	
N7002A	16 GHz InfiniiMax III+ probe amplifier	
N7001A	13 GHz InfiniiMax III+ probe amplifier	
N7000A	8 GHz InfiniiMax III+ probe amplifier	
N2832A	13 GHz InfiniiMax III+ probe amplifier	Infiniium MXR, EXR, S-Series, 9000, and 90000A Series, UXR (3.5 mm models), V, Z, Q, and 90000X Series with N5442A adapter, UXR (1 and 1.85 mm models) with both N5442A and N2852A adapters
N2831A	8 GHz InfiniiMax III+ probe amplifier	
N2830A	4 GHz InfiniiMax III+ probe amplifier	

Note: InfiniiMax III and III+ probe amps are not compatible with existing InfiniiMax I or II probe heads.

InfiniiMax III/III+ probe heads

Model number	Description	Notes
N2848A	InfiniiMax III QuickTip probe head	Compatible with InfiniiMax III/III+ amp
		Supports InfiniiMode with InfiniiMax III+ amp
		Order N2849A QuickTip tips (set of 4)
N5445A	InfiniiMax III browser head	Order N5476A for replacement probe tips (set of 4)
N5439A	InfiniiMax III ZIF probe head	Order N2838A PC board ZIF (450 Ω), N5440A ceramic ZIF (450 Ω) or N5447A Ceramic ZIF (200 Ω) for a set of 5 ZIF tips with plastic sporks. Order N2838-68701 (10x 130 ohm resistors) for N2838A tip resistor replacement.
N5444A	InfiniiMax III 2.92 mm/3.5 mm/SMA probe head	Order N5448B (25 cm) or N2823A (1 m) 2.92 mm head flex cables to extend the cable length. Supports InfiniiMode with InfiniiMax III+ amp
MX0109A	InfiniiMax III 26 GHz extreme temperature solder-in probe head	Supports -55 to +150 °C of operating temperature range and InfiniiMode with InfiniiMax III+ amp. Order N2838-68701 (10x 130 ohm resistors) for tip resistor replacement.
N2835A	InfiniiMax III/III+ differential connectivity kit	Containing N5445A InfiniiMax III browser head (qty 1)
		N2836A InfiniiMax III 26 GHz solder-in head (qty 2)
		N5439A InfiniiMax III ZIF head (qty 2)
		N2838A InfiniiMax III ZIF tip kit (qty 2)
		N2848A InfiniiMax III QuickTip head (qty 2)
N2849A QuickTip tips (qty 2)		

Note: N54xxA InfiniiMax III/III+ probe heads are not compatible with InfiniiMax I or II probe amps.

InfiniiMax III probe adapters

Model number	Description	Notes
N5442A	Precision BNC adapter (50 Ω)	For use with InfiniiMax I/II/III+ 1130B/31B/32B/34B/68B/69B and N2830A/31A/32A probes, N2750A-52A, N2795A/96A/97A, 1156A-58A etc.
N5449A	High impedance probe adapter	Includes one N2873A 500MHz 10:1 passive probe
N5477A	Sampling scope adapter	For InfiniiMax III amp to use with Keysight 86100C DCA-J sampling scope
N1022B	Probe adapter	For InfiniiMax III+ amp to use with 86100C DCA-J sampling scope
N5443A	Performance verification and deskew fixture	For InfiniiMax III and InfiniiMax III+ > 13 GHz
E2655C	Performance verification and deskew fixture	For InfiniiMax III+ ≤13 GHz and InfiniiMax I/II

Probe bandwidth upgrade options (for InfiniiMax III only)

Model number	Description	Notes
N5446A-001	16 to 20 GHz bandwidth upgrade	
N5446A-002	20 to 25 GHz bandwidth upgrade	
N5446A-003	25 to 30 GHz bandwidth upgrade	
N5446A-004	16 to 25 GHz bandwidth upgrade	
N5446A-005	16 to 30 GHz bandwidth upgrade	
N5446A-006	20 to 30 GHz bandwidth upgrade	

Note: To upgrade the probe bandwidth, you simply need to send the probe to the Keysight service center.

Other recommended accessories for InfiniiMax III/III+ probing system

Model number	Description	Notes
N2787A	3D probe positioner	For hands-free probing
N5450B	Extreme temperature extension cable	1 m long
N2812A	High performance input cable, 2.92 mm connectors, 1 m length	For use with Infiniium V, 90000-X/Q Series oscilloscope
N2823A	Cable assembly, coax phase matched pair, 1 m	2.92 mm (m) to 2.92 mm (m)
N5448B	Cable assembly, coax phase matched pair, 25 cm	2.92 mm (m) to 2.92 mm (m)
MV-23	Carson Optical MagniVisor	https://carson.com/products/magnivisor-mv-23/

InfiniiMax Gen II Probes

Key features

- Up to 13 GHz bandwidth for differential, solder-in, browser, and SMA connections
- Low noise and flat frequency response
- Industry's widest variety of differential probe head types

Scope compatibility

See the table on page 3.

The InfiniiMax II Series 1168B/69B probing system provides real-time bandwidth to 12 GHz specified and has 13 GHz typical performance. The innovative InfiniiMax probing system supports even the most demanding mechanical access requirements without sacrificing performance.

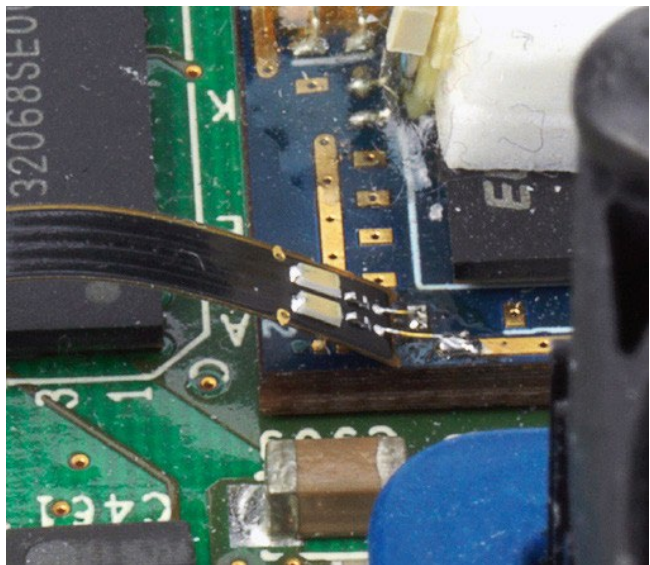

Characterized performance plots: 1169B with N5381B differential solder-in probe head

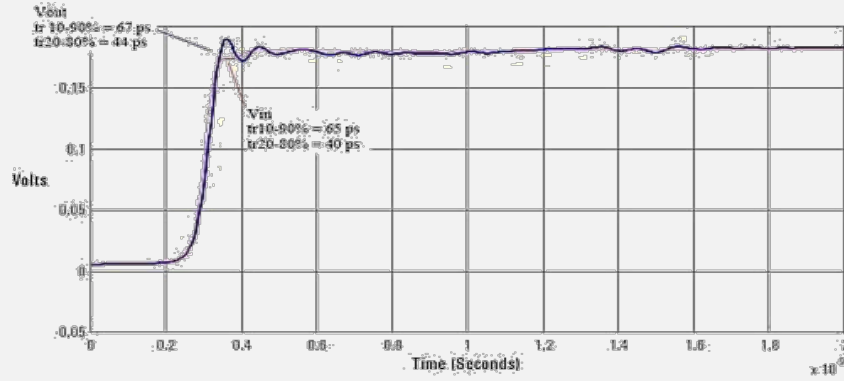

Graph of Vin and Vout of 1169B and N5381B solder-in head with a 25 Ω 58 psec step generator

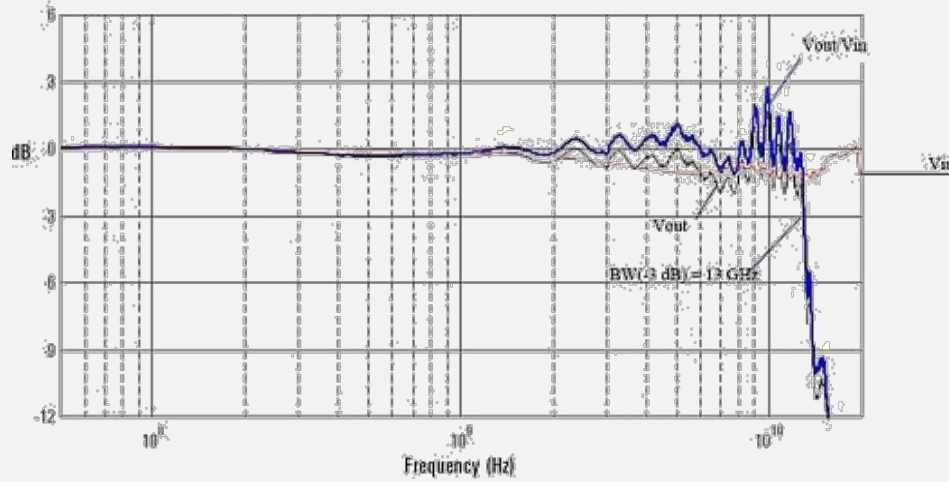

Frequency response of 1169B and N5381B with a 25 Ω source

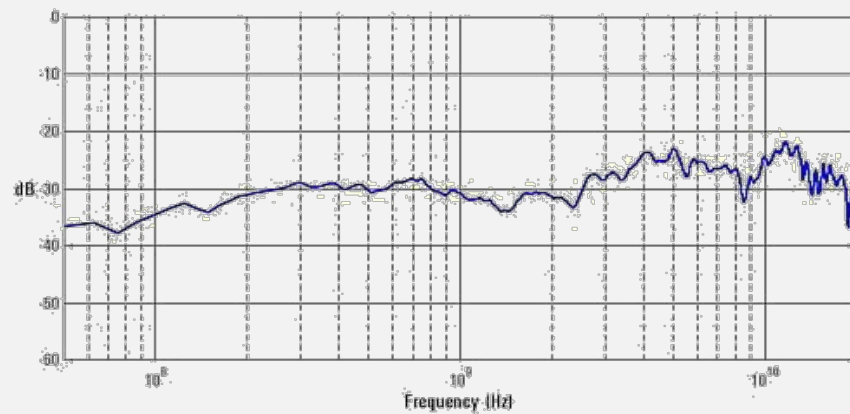

Common mode rejection ratio of 1169B

Ordering information

InfiniiMax II Series probe amplifiers

Model number	Bandwidth	Description
1169B	12 GHz (spec) 13 GHz (typical)	InfiniiMax II probe amplifier – order one or more probe heads
1168B	10 GHz	InfiniiMax II probe amplifier – order one or more probe heads

InfiniiMax probe amplifier specifications: Dynamic range = 3.3 V, DC offset range = ± 16 V, maximum voltage = ± 30 V.

InfiniiMax II Series probe heads

InfiniiMax II Series probe heads are recommended for 1168B/69B probe amplifiers. When used with a compatible Infiniium oscilloscope with >12 GHz bandwidth, the MX0100A, N5380B, N5381B, and N2839A will typically achieve 13 GHz bandwidth.

Probe head	Model number	Differential measurement (BW, input C, input R)	Single-ended measurement (BW, input C, input R)
Hi-BW Micro probe head	MX0100A	12 GHz, 0.17 pF, 50 kΩ	12 GHz, 0.26 pF, 25 kΩ
Hi-BW differential SMA	N5380B	12 GHz	12 GHz
Hi-BW differential solder-in	N5381B	12 GHz, 0.21 pF, 50 kΩ	12 GHz, 0.35 pF, 25 kΩ
ZIF solder-in	N5425B		
	with N5426A	12 GHz, 0.33 pF, 50 kΩ	12 GHz, 0.53 pF, 25 kΩ
	with N5451A 7 mm, 0 deg	9.9 GHz, —, 50 kΩ	9.9 GHz, 0.6 pF, 25 kΩ
	with N5451A 11 mm, 0 deg	5 GHz, —, 50 kΩ	5 GHz, 0.68 pF, 25 kΩ
	with N2884A	12 GHz, 350 fF, 50 kΩ	12 GHz, 320 fF, 25k Ω
QuickTip	N2851A head with N2849A tips	12 GHz, 0.2 pF, 50 kΩ	12 GHz, 0.34 pF, 25 kΩ
Hi-BW differential browser	N2839A	12 GHz, 0.21 pF, 50 kΩ	12 GHz, 0.34 pF, 25 kΩ
InfiniiMax II differential connectivity kit	N2833A	Containing N2839A InfiniiMax II browser head (qty 1)	
		N5381B InfiniiMax II solder-in head (qty 2)	
		N5425B InfiniiMax II ZIF head (qty 2)	
		N5426A ZIF tip kit (qty 2)	
		N2851A InfiniiMax II QuickTip head (qty 2)	
		N2849A QuickTip tips (qty 2)	

InfiniiMax II probing system tree diagram

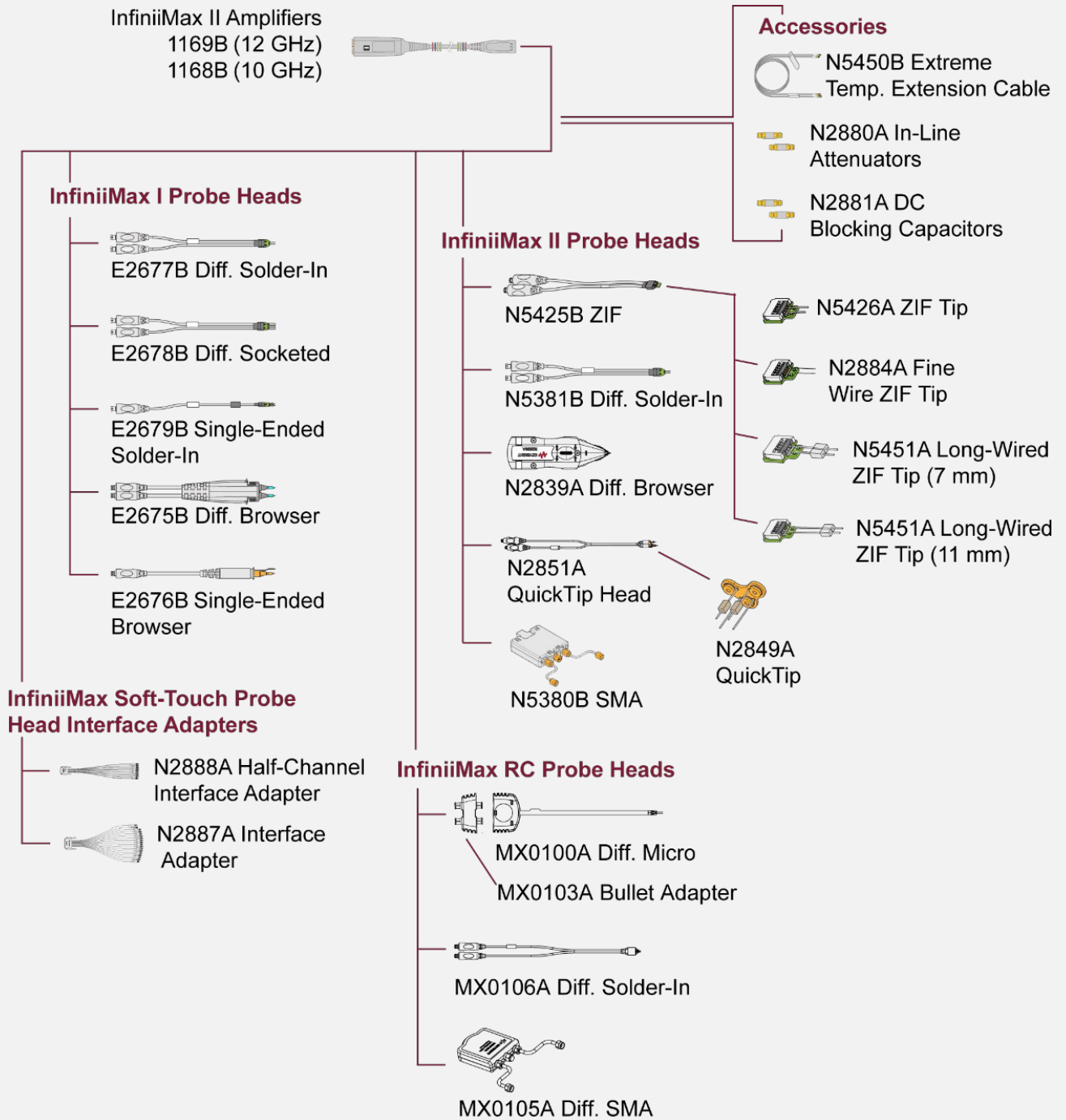

Performance characteristics

	1169B	1168B
Bandwidth ¹	1169B: 12 GHz (13 GHz typical)	1168B: > 10 GHz
Rise and fall time <ul style="list-style-type: none"> • Probe only • When phase compensated by 90000A Series oscilloscope 	1169B: 28 ps (20 to 80%), 40 ps (10 to 90%)	1168B: 34 ps (20 to 80%), 48 ps (10 to 90%)
	1169B with 91204A: <ul style="list-style-type: none"> • 25 ps (20 to 80%) • 36 ps (10 to 90%) 	1168B with 90804A: 38 ps (20 to 80%)
	1169B with 91304A: <ul style="list-style-type: none"> • 23 ps (20 to 80%) • 33 ps (10 to 90%) 	54 ps (10 to 90%)
System bandwidth (–3 dB)	1169B with 91304A: 13 GHz (typical) 1169B with 91204A: 12 GHz	1168B with 90804A: 8 GHz
Input capacitance ²	C _m = 0.09 pF C _m is between tips	
	C _g = 0.26 pF C _g is to ground for each tip	
	C _{diff} = 0.21 pF Differential mode capacitance = C _m + C _g /2	
	C _{se} = 0.35 pF Single-ended mode capacitance = C _m + C _g	
Input resistance ¹	Differential mode resistance = 50 kΩ ± 2%	
	Single-ended mode resistance = 25 kΩ ± 2%	
Input dynamic range	3.3 V peak to peak, ± 1.65 V	
Input common mode range	± 6.75 V DC to 100 Hz; ± 1.25 V > ± 100 Hz	
Maximum signal slew rate	25 V/ns when probing a single-ended signal	
	40 V/ns when probing a differential signal	
DC attenuation	3.45:1	
Zero offset error referred to input	± 1.5 mV	
Offset range	± 16.0 V when probing single-ended	
Offset gain accuracy	< ± 1% of setting when probing single-ended	
Noise referred to input	2.5 mV rms, probe only	
Propagation delay	~6 ns (this delay can be deskewed relative to other signals)	
Maximum input voltage	30 V peak, mains isolated	
ESD tolerance	> 8 kV from 100 pF, 300 Ω HBM	
Temperature	Operating: 5 to +40 °C	
	Non-operating: 0 to +70 °C	

1. Denotes warranted specifications, all others are typical.

2. Measured using the probe amplifier and solder-in differential probe head with full bandwidth resistors.

InfiniiMax Gen I Probes

Key features

- Up to 7 GHz bandwidth for differential, solder-in, browser, and SMA connections
- Low noise and flat frequency response
- Wide dynamic range (± 2.5 V) and offset range (± 12 V)

Scope compatibility

See the table on page 3.

For high-speed differential or single-ended probing in embedded designs, the InfiniiMax 1130B Series differential probe amplifiers are perfect complements to the Infiniium 600 MH to 6 GHz oscilloscopes. Its extremely low input capacitance, flat frequency response and the patented resistor probe tip technology provide ultra low loading of the DUT and superior signal fidelity.

Characterized performance plots: with E2677B differential solder-in probe head

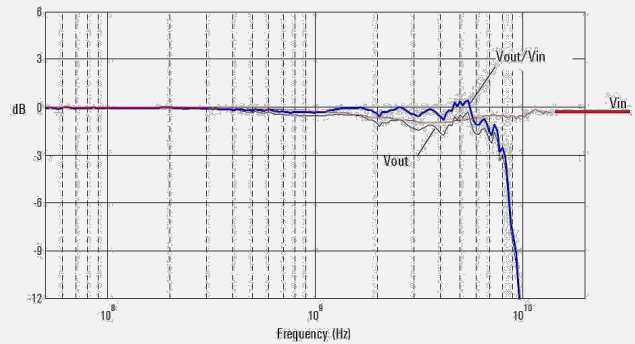
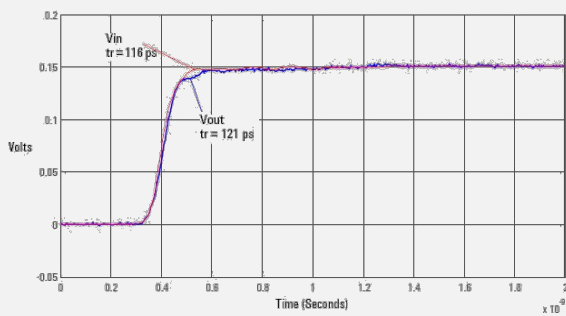

Vin and Vout of probe with a 25- Ω , 100 psec step signal

Swept frequency response with a 25- Ω source

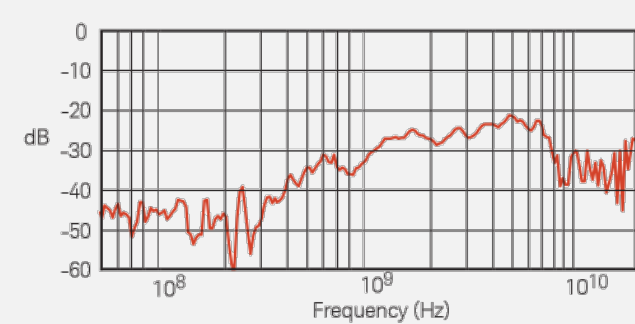
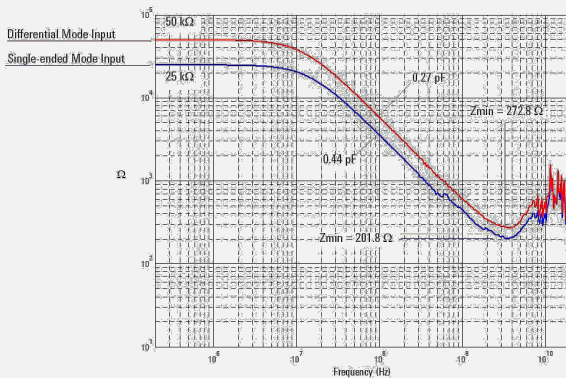

Probe input impedance versus frequency

Common mode rejection versus frequency

InfiniiMax I probing system tree diagram

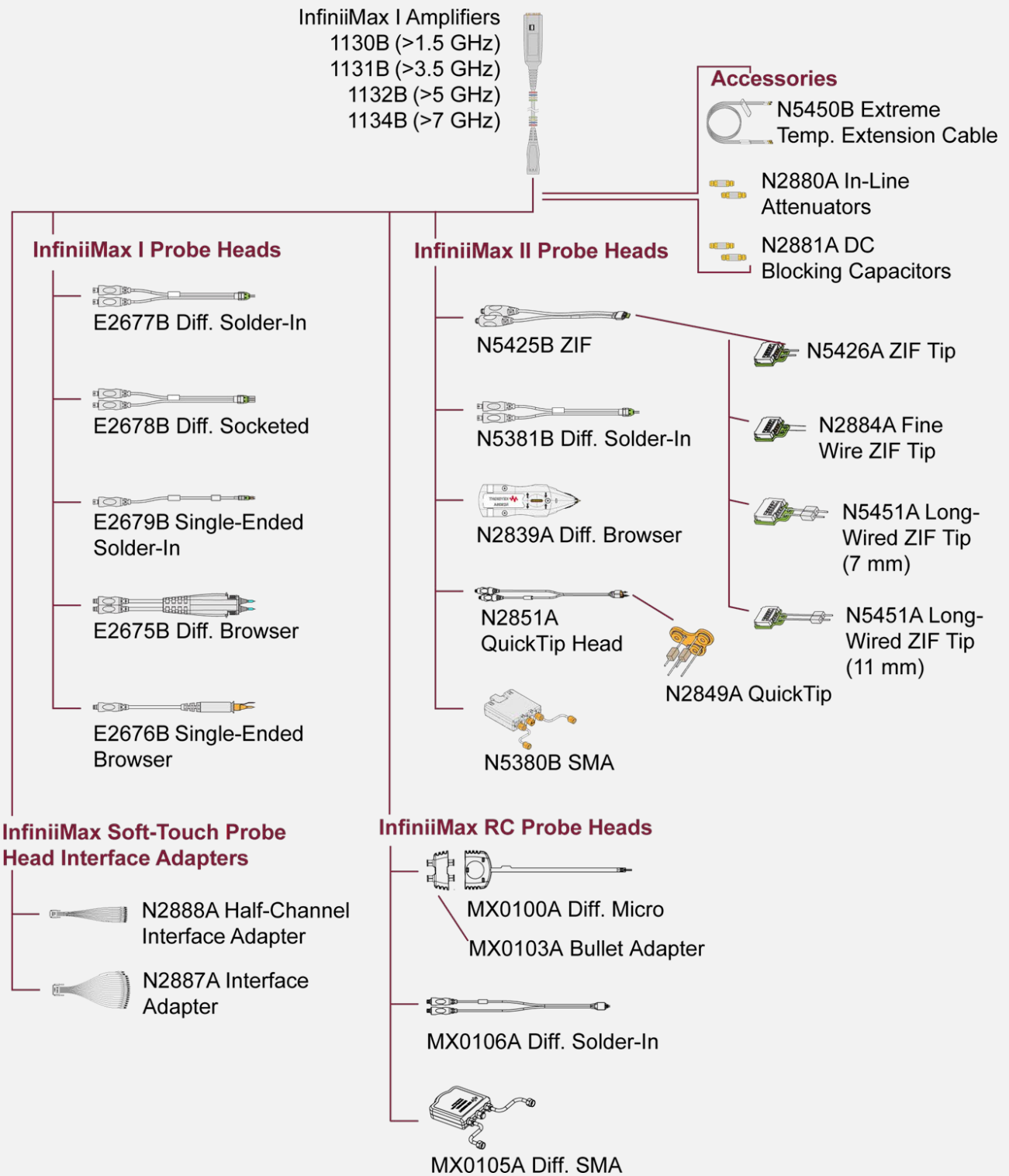

Performance characteristics

	1130B/31B/32B/34B
Probe bandwidth ¹	1134B: 7 GHz
	1132B: 5 GHz
	1131B: 3.5 GHz
	1130B: 1.5 GHz
Rise and fall time (10 to 90%)	1134B: 60 ps
	1132B: 86 ps
	1131B: 100 ps
	1130B: 233 ps
System bandwidth (–3 dB)	1134B with DSO/DSA90604A: 6 GHz
	1132B with DSO/DSA90404A, DSO/MSO9404A: 4 GHz
	1131B with DSO/DSA90254A, DSO/MSO9254A: 2.5 GHz
	1130B with DSO/MSO9104A: 1 GHz
	1130B with DSO/MSO9064A: 600 MHz
Input capacitance ²	C _m = 0.1 pF C _m is between tips.
	C _g = 0.34 pF C _g is to ground for each tip.
	C _{diff} = 0.27 pF Differential mode capacitance = C _m + C _g /2
	C _{se} = 0.44 pF Single-ended mode capacitance = C _m + C _g
Input resistance	Differential mode resistance = 50 kΩ ± 2%
	Single-ended mode resistance = 25 kΩ ± 2%
Input dynamic range	± 2.5 V
Input common mode range	± 6.75 V DC to 100 Hz; ± 1.25 V > 100 Hz
Maximum signal slew rate	18 V/ns when probing a single-ended signal
	30 V/ns when probing a differential signal
DC attenuation	10:1 ± 3% before calibration on oscilloscope
	10:1 ± 1% after calibration on oscilloscope
Zero offset error referred to input	< 30 mV before calibration on oscilloscope
	< 5 mV after calibration on oscilloscope
Offset range	± 12.0 V when probing single-ended
Offset accuracy	< 3 % setting before calibration on oscilloscope
	< 1 % setting after calibration on oscilloscope
Noise referred to input	3.0 mV _{rms}
Propagation delay	~6 nsec (This delay can be deskewed relative to other signals.)
Maximum input voltage	30 V _{peak} , mains isolated
ESD tolerance	> 8 kV from 100 pF, 300 Ω HBM

1. Denotes warranted specifications, all others are typical.

2. Measured using the probe amplifier and solder-in differential probe head with full bandwidth resistors.

Ordering information

InfiniiMax I probe amplifier models

Model number	Description	Quantity
1134B	7 GHz InfiniiMax probe amplifier (order one or more probe heads or connectivity kits per amplifier)	1
1132B	5 GHz InfiniiMax probe amplifier (order one or more probe heads or connectivity kits per amplifier)	1
1131B	3.5 GHz InfiniiMax probe amplifier (order one or more probe heads or connectivity kits per amplifier)	1
1130B	1.5 GHz InfiniiMax probe amplifier (order one or more probe heads or connectivity kits per amplifier)	1

InfiniiMax I connectivity kits models

Model number	Description	Quantity
E2669B	InfiniiMax connectivity kit for differential/single-ended measurements. Includes one differential browser, four solder-in differential probe heads and two socketed differential probe heads. Includes all necessary accessories	1
E2668B	InfiniiMax connectivity kit for single-ended measurements. Includes one single-ended browser, one solder-in probe heads and one socketed probe heads. Includes all necessary accessories	1

InfiniiMax I individual probe heads

Model number	Description	Quantity
E2675B	InfiniiMax differential browser probe head and accessories. Includes 20 replaceable tips and ergonomic handle. Order E2658A for replacement accessories	1
E2676B	InfiniiMax single-ended browser probe head and accessories. Includes 2 ground collar assemblies, 10 replaceable tips, a ground lead socket, and ergonomic handle. Order E2663A for replacement accessories	1
E2677B	InfiniiMax differential solder-in probe head and accessories. Includes 20 full bandwidth and 10 medium bandwidth damping resistors. Order E2670B for replacement accessories	1
E2678B	InfiniiMax single-ended/differential socketed probe head and accessories. Includes 48 full bandwidth damping resistors, 6 damped wire accessories, 4 square pin sockets, and socket heatshrink. Order E2671A for replacement accessories	1
E2679B	InfiniiMax single-ended solder-in probe head and accessories. Includes 16 full bandwidth, 8 medium bandwidth damping resistors, and 24 zero ohm ground resistors. Order E2672A for replacement accessories	1

InfiniiMax I adapters

Model number	Description	Quantity
N1022B	Adapts InfiniiMax I/II active probes to 86100 Infiniium DCA	1
N2887A	InfiniiMax Soft touch pro probe adapter (36 channel, up to 4 GHz)	1
N2888A	InfiniiMax Soft touch half-channel probe adapter (18 channel, up to 4 GHz)	1

Optical-to-Electrical Converters — N7005A 60 GHz

- DC to 60 GHz typical (-3 dBe, electrical)
- Single-mode input
- 9/125 μm , 1250 nm - 1600 nm (covers main wavelengths: 1310 nm, and 1550 nm)
- FlexDCA SW supports PAM4 measurement capabilities such as TDECQ
- Optical measurement features built into the Infiniium UXR baseline software version
- 10.25 patch or higher
- Compatible with Infiniium UXR oscilloscope with ≥ 40 GHz bandwidth

The N7005A is a 60 GHz (-3 dB, Brickwall) O/E converter compatible with Keysight UXR oscilloscope with 1.85 mm or 1 mm input. The frequency response of a DSP corrected N7005A is either flat to up to 60 GHz Brickwall response or it follows a 4th order Bessel Thomson response until it hits the Brickwall at 70 GHz. The N7005A used in conjunction with 70 GHz Infiniium UXR oscilloscope supports 4th order Bessel Thomson response to view optical streams at speeds up to 56 Gbaud PAM4, making this the ideal solution for characterizing or troubleshooting high-speed optical signals in system level testing and debugging.

Infiniium UXR baseline software v 10.25 patch or higher covers basic optical measurement features and dark calibration. The FlexRT measurement software installed on Infiniium UXR oscilloscope supports deep analysis of PAM4 signaling measurement capabilities such as TDECQ.



Optical-to-Electrical Converters — N7004A 33 GHz

- DC to 33 GHz typical (–3 dBe, electrical)
- Single-mode and multimode inputs
- 50/125 μm , 750 to 1650 nm (covers main wavelengths: 850 nm, 1310 nm, and 1550 nm)
- Designed for reference receiver testing of industry optical standards or characterizing raw response of an optical transmitter
- Optical measurement features built into the Infiniium baseline software version 05.70 or higher
- Compatible with Infiniium UXR, V-Series, 90000 X-Series, Z-Series and discontinued 90000 Q-Series real-time oscilloscopes



The Keysight N7004A optical-to-electrical converter is a high-sensitivity photodetector module designed for direct optical-to-electrical conversion of optical telecom or data com signals into an Infiniium real-time oscilloscope with AutoProbe II interface.

The N7004A is the first fully-integrated optical-to-electrical converter solution for Infiniium real-time oscilloscopes. A full suite of optical measurement software is built into the Infiniium baseline software v 05.70 and is offered at no additional cost. The N7004A comes in a compact form factor that is plugged directly into the AutoProbe II probe interface of the Infiniium oscilloscope.

The adapter provides from DC to 33 GHz of electrical bandwidth. When used with an Infiniium V-Series or Z-Series 33 GHz oscilloscope, the N7004A allows users to view optical streams at speeds up to 28 Gbps, making this the ideal solution for characterizing or troubleshooting high-speed optical signals in the system level testing. The N7004A with an Infiniium real-time oscilloscope is the ideal solution for users who want to see the unfiltered response of optical transmissions as well.

Each N7004A adapter contains its unique S-parameter correction filter, and this frequency response data is used to flatten the frequency response for more accurate measurement.

The input is a 50 μm /125 μm fiber that can be used with 9 μm single-mode fiber or 50 μm multimode fiber at wavelengths from 750 to 1650 nm and has a FC/PC adaptor. The reference receiver measurement is made with a built-in 4th order Bessel Thomson software filter that allows the waveform to be viewed similarly to what an optical receiver in an actual communication system would display. The 4th order Bessel Thomson filter bandwidth is limited to 2/3 of the Brickwall bandwidth of the oscilloscope. For a 33 GHz oscilloscope with the Bessel Thomson filter on, this yields a 22 GHz Bessel Thomson filter, which covers $28 \text{ Gbps} \times 0.75 = 21 \text{ GHz}$.

Optical and electrical characteristics and specifications

	N7004A	N7005A
Bandwidth, typical (electrical, -3 dBe)	33 GHz (with Brickwall filter)	60 GHz (with Brickwall filter)
	22 GHz (with 4th order Bessel Thomson filter)	46.6 GHz (with 4th order Bessel Thomson filter)
Bandwidth, warranted (electrical, -3 dBe)	32 GHz (with Brickwall filter)	
	21.3 GHz (with 4th order Bessel Thomson filter)	
Rise time (10 to 90%), typical	13.3 psec (with Brickwall filter)	7.3 psec (with Brickwall filter)
	17.7 psec (with 4th order Bessel Thomson filter)	8.4 psec (with 4th order Bessel Thomson filter)
Rise time (20 to 80%), typical	9.4 psec (with Brickwall filter)	5.2 psec (with Brickwall filter)
	12.3 psec (with 4th order Bessel Thomson filter)	5.8 psec (with 4th order Bessel Thomson filter)
Optical output coupling	DC	
Wavelength range	750 to 1650 nm	1250 to 1600 nm
RMS noise (μ W)	See the noise characteristics table on the N7005A user's guide	
Conversion gain (V/W)	850 nm MM: 68 (min), 75 (typical)	
	1310 nm MM/SM: 105 (min), 110 (typical)	1310 nm SM: 85 (min), 93 (typical)
	1550 nm SM: 105 (min), 110 (typical)	1550 nm SM: 72 (min), 85 (typical)
Maximum linear input power	4 mW	
	8 mW	
Input return loss (dB)	850 nm MM: -17 (typical), -15 (max) (fully filled fiber)	
	1310 nm SM: -18.5 (typical), -16 (max)	1310 nm SM: -25 (max)
	1550 nm SM: -14 (typical)	1550 nm SM: -25 (max)
Connector type	FC/PC to 50/125 μ m fiber, compatible with single-mode or multimode fiber	FC/PC to 9/125 μ m fiber, compatible with single-mode fiber
Infiniium software features	Optical measurements in watts, extinction ratio with dark calibration, eye mask testing (including ability to load DCA masks with margin and user defined mask support), power of 1 and 0, optical modulation amplitude, average power, remote command support for all new features.	
Oscilloscope compatibility	Infiniium UXR, V, 90000X, Z series and discontinued 90000 Q series	Infiniium UXR with 40 GHz or higher
Oscilloscope software compatibility	Infiniium software version 05.70 or higher for Infiniium non-UXR	Infiniium software version 10.25 for UXR models
	Infiniium software version 10.25 or higher for UXR models	



Figure 1. A full suite of optical measurement software is built into the Infiniium baseline software.

Active Termination Adapter — N7010A

- 30-GHz single-ended active termination adapter supporting 2.92 mm/3.5 mm/SMA cable input
- Low attenuation setting (1.16:1) for high SNR, low noise measurements
- Ability to terminate signal to a 50 Ω non-ground voltage (VTERM)
- Compatible with Infiniium UXR, 90000Q, Z-Series, or V-Series installed with software version 5.30 or higher, and Infiniium 90000X with 5.50.0030 or higher



To date, most oscilloscopes with 50 Ω inputs terminate to ground by definition. However, a particular communication system often requires the 50 Ω termination to a voltage rather than to ground. The Keysight N7010A active termination adapter is a 30-GHz single-ended adapter featuring a user-adjustable common termination voltage (VTERM) and extremely low noise performance. The termination voltage between –4.0 to +4.0 V can be controlled internally by the oscilloscope. The N7010A is a single-ended adapter. Two scope channels and two adapters are needed for making differential measurement, which allow the A-to-GND, B-to-GND and differential (A-B) signals to be viewed in real time.

Utilizing low attenuation ratio setting (1.16:1), the adapter enables an extremely lower noise floor, especially at high-sensitivity vertical scales (< 400 mV) when compared to the Keysight InfiniMax III probe with the N5444A SMA/2.92 mm head.

Key characteristics and specifications	N7010A
Bandwidth ¹	30 GHz (warranted), 32 GHz (typical)
Rise time (10 to 90%)	14.5 ps
Attenuation ratio	1.16:1
Noise with oscilloscope	See chart
V _{in} max active signal	1.2 V _{pp} (not including DC component)
V _{term} range	–4 to +4 V
V _{term} accuracy	± 2 mV
V _{offset} range	–4 to +4 V
Input signal range (V _{in} - V _{term} difference)	–0.6 V ≤ (V _{in} — V _{term}) ≤ +0.6 V
Input resistance at DC ¹	50 Ω ± 3 %
Max non-destructive input voltage	± 8 V

1. Warranted specifications.

Noise of N71010A with Infiniium V-Series oscilloscopes



Eye diagram comparison with MIPI® M-PHY® Gear 3 data rate at 5.8304 Gb/s, amplitude swing: = 140 mVpp

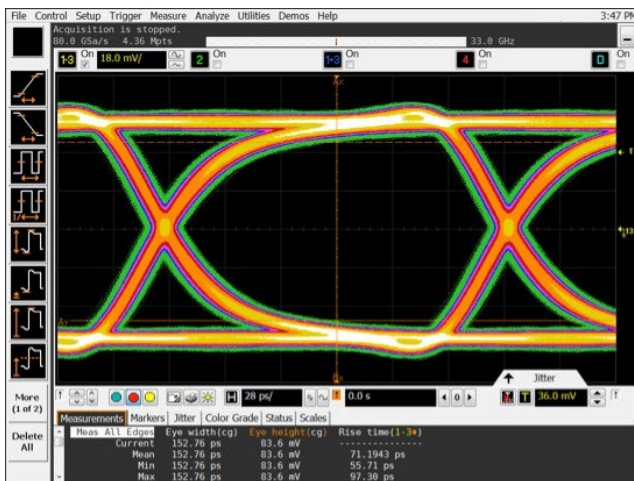

Figure 2. Direct signal connect to Infiniium scope

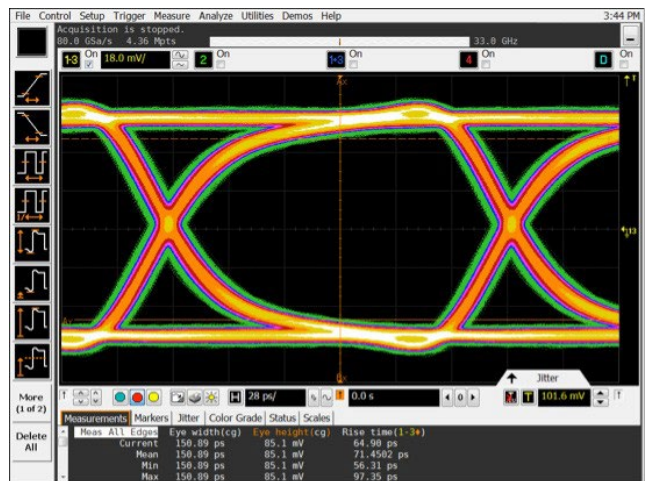

Figure 3. Signal through N71010A active termination adapter; N71010A not inherently contribute noise

InfiniiMode Active Probes — N2750A/51A/52A

InfiniiMode active probes N2750A/51A/52A InfiniiMode probes

- 1.5, 3.5, and 6 GHz probe bandwidth models
- Dual attenuation ratio (2:1/10:1)
- High input resistance (200 k Ω differential, 100 k Ω single-ended)
- Wide input dynamic range (10 Vpp) and offset range (± 15 V)
- High CMRR (> 60 dB at 1 MHz)
- InfiniiMode probing for making differential, single-ended, and common mode measurements with a single probe
- Built-in quick action scope control for quick access to a variety of scope functions
- Built-in headlight
- Includes solder-in, browser, and socketed tips standard
- AutoProbe interface for auto configuration and probe power for Infiniium scopes



The N2750A Series InfiniiMode differential probes are a new generation of low-cost, 1.5, 3.5, and 6 GHz differential active probes compatible with Infiniium oscilloscope's AutoProbe interface

Measurement versatility

The N2750A Series differential probes offer 2:1 and 10:1 dual attenuation settings, allowing them to be used for a broad range of applications. Dual attenuation range is automatically configured depending on the size of the input signal.

The new differential probes have an input resistance of 200 k Ω (differential) or 100 k Ω (each input to ground) and an extremely low input capacitance of 700 fF to minimize circuit loading. This, accompanied with superior signal fidelity, makes these probes useful for most digital design and debug applications. And with their wide dynamic range (10 Vpp) and offset range (± 15 V), these probes can be used in a wide variety of analog signal measurements as well.

InfiniiMode usability

The N2750A Series probes come with new InfiniiMode operation modes. The InfiniiMode allows convenient measurements of differential, single-ended, and common mode signals with a single probe tip without reconnecting the probe to change the connection. The N2750A probe's InfiniiMode provides the following modes of operation.

- A – B (differential)
- A – ground (single-ended A)
- B – ground (single-ended B)
- (A+B)/2 – ground (common mode)

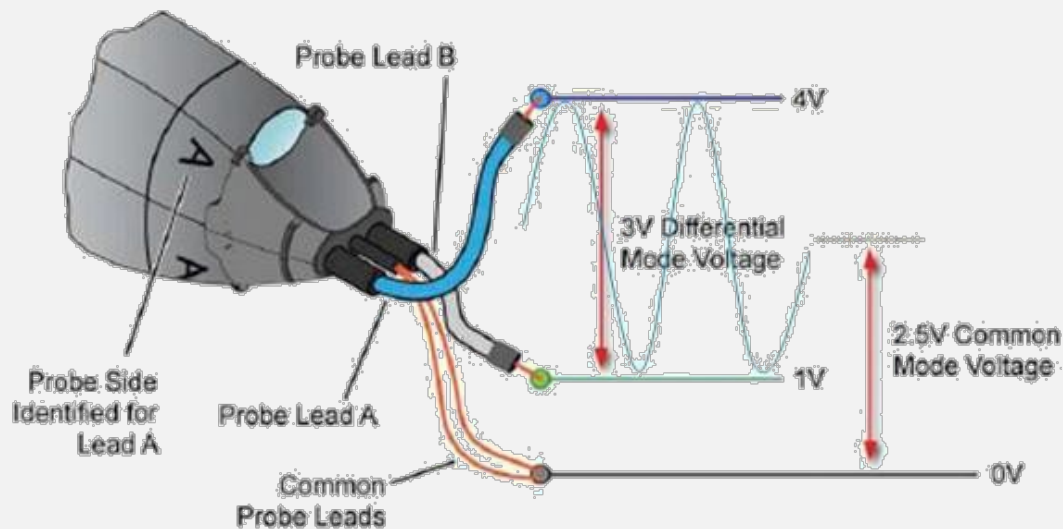

The InfiniiMode probe allows convenient measurements of differential, single-ended (A and B) and common mode signals with a single probe

Quick action scope control

The N2750A Series differential probes provide convenient and quick access to various functions on the scope. You often have a need to control the scope while you hold a probe in your hand. With the quick action scope control feature built into the probe, you can turn the built-in headlight of the probe on and off or control some frequently used scope functions, such as RUN/STOP, auto scale, quick print, and quick save with only the push of a button on the probe. Get control of your most needed function with a push of the quick action control button on the probe.

Flexibility in probe use models is also a vital necessity. The probes come standard with three different types of exchangeable probe tips that allow for easy connections to the circuit under test. These probe tips enable you to access multiple signals on anything from header connectors to hard-to-reach, high-density circuitry. The probes are equipped with a white LED headlight to illuminate the circuit under test which will help you see where you are probing.

The probes are powered directly by the Infiniium AutoProbe interface, eliminating the need for an additional power supply.

Characteristics and specifications			
Model number	N2750A	N2751A	N2752A
Probe bandwidth 1 (-3 dB)	1.5 GHz	3.5 GHz	6 GHz (warranted), 7 GHz (typical)
Rise time, probe only (10 to 90%)	233 psec	100 ps	58.3 ps
System bandwidth (with Keysight oscilloscope)	1 GHz (with Keysight's Infiniium oscilloscope)	2.5 GHz (with Keysight's Infiniium oscilloscope)	4/6 GHz (with Keysight's Infiniium oscilloscope)
Input resistance (at DC) ¹		200 kΩ ± 2% (differential mode)	
		100 kΩ ± 2% (single- ended mode)	
		50 kΩ ± 2% (common mode)	
Input capacitance		700 fF (with browser)	
Attenuation ratio (at DC)		2:1 / 10:1	
Input dynamic range		± 1 V, 2 Vpp (at 2:1)/ ± 5 V, 10 Vpp (at 10:1)	
Input common mode range		± 15 V (from DC to 100 Hz), ± 2.5 V (for > 100 Hz) ³	
Offset range		± 15 V	
Offset accuracy ²		< 3%	
Maximum non-destructive input voltage		± 30 V (DC + peak AC) mains isolated	

1. Denotes warranted electrical specifications at 2:1 attenuation mode after 20 minute warm-up. All others are typical.
2. When calibrated on the oscilloscope, these characteristics are determined by the oscilloscope characteristics.
3. Assumes symmetric differential signals.

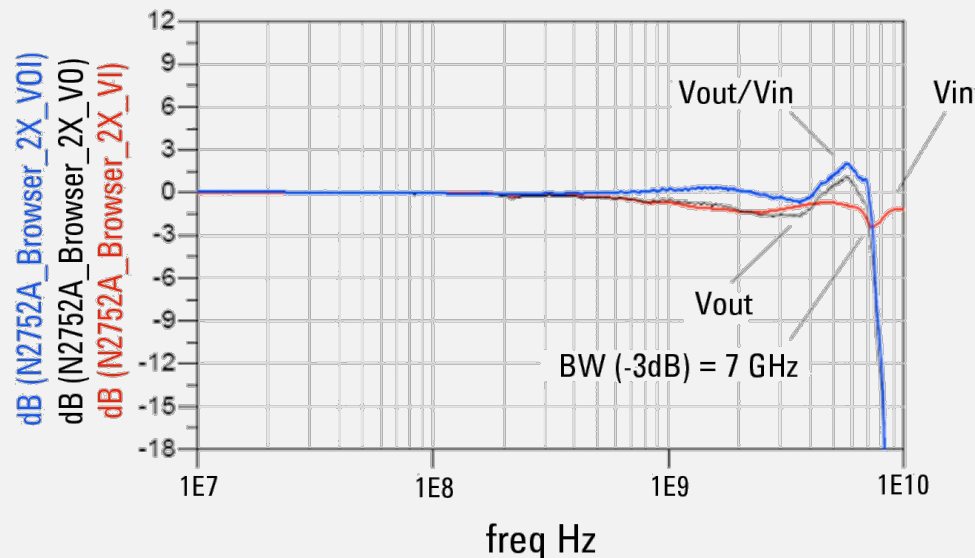

V_{out}/V_{in} frequency response of N2752A (at 2:1) with browser tip

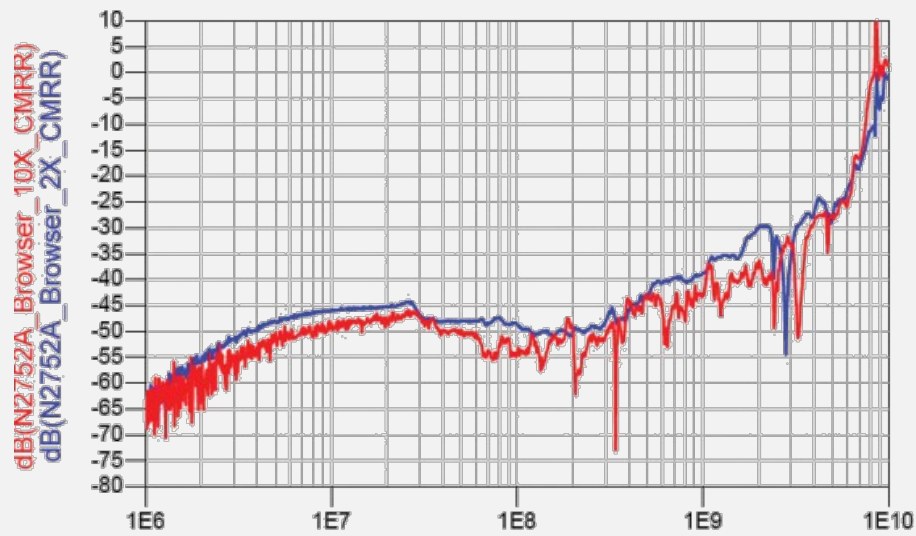

Common mode rejection ratio (red= 2:1, blue= 10:1)

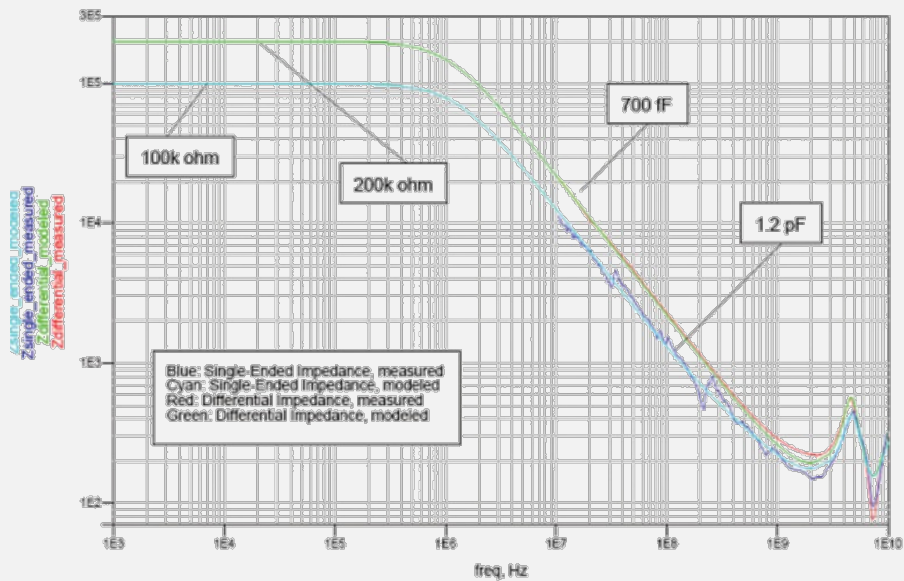

V_{out}/V_{in} frequency response of N2752A (at 2:1) with browser tip

Ordering information	
Model number	Description
N2750A	1.5 GHz InfiniiMode differential probe
N2751A	3.5 GHz InfiniiMode differential probe
N2752A	6 GHz InfiniiMode differential probe
N2776A	Differential browser tips (qty 3)
N2777A	InfiniiMode solder-in tips (qty 3)
N2778A	InfiniiMode socketed tips (qty 3)
N4822A	Socketed tip for USB/Ethernet application fixtures (qty 1)

The N2750A/51A/52A InfiniiMode probes include two browser tips, two socketed tips, and two solder-in tips as standard. The N4822A is not included in the N2750A-52A probe.

Other recommended accessories	
Model number	Description
N2787A	3D probe positioner
E2655C	Performance verification and deskew fixture
N5442A	Precision BNC adapter for V-Series, 90000X/Q Series oscilloscopes

For more information about the N2750A Series InfiniiMode probes, refer to the datasheet with the Keysight literature number, 5991-0560EN.

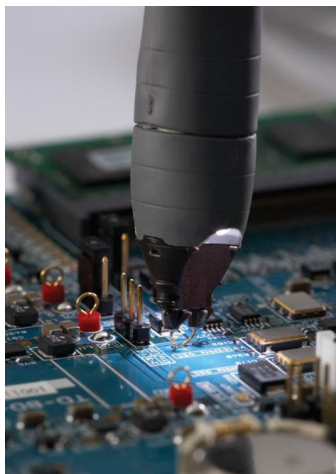

N2750A with browser tip



N2750A with solder-in tip



N2750A with socketed tip



N2750A with N4822A socketed tip for application fixtures

Single-Ended Active Probes — N2795A/96A/97A

- High resistance (1 M Ω) and low capacitance (1 pF) input for low loading
- Wide input dynamic range (± 8 V) and offset range (± 12 V for N2796A/97A, ± 8 V for N2795A)
- Built-in headlight
- Direct connection to AutoProbe interface (no power supply required)
- N2797A for extreme temperature environmental chamber testing at -40 to $+85$ °C

The N2795A/96A are a new generation of low-cost, 1 to 2 GHz single-ended active probes with the AutoProbe interface (compatible with Keysight's Infiniium family of oscilloscopes). These probes integrate many of the characteristics needed for today's general-purpose, high-speed probing—especially in digital system design, component design/characterization, and educational research applications. Its 1 M Ω input resistance and extremely low input capacitance (1 pF) provide ultra low loading of the DUT. This, accompanied with superior signal fidelity, makes these probes useful for most of today's digital logic voltages.

Testing devices over extreme temperature ranges is quite common these days. The N2797A 1.5 GHz single-ended active probe is the industry's first low-cost high input impedance active probe with rugged probe tips for environmental chamber testing of ICs and devices. The probe gives the ability to probe signals at drastic temperature swings ranging from -40 to $+85$ °C. The probe provides a 2-m long cable. Order N2798A for replacement accessories.

The N2795A/96A/97A are equipped with a white LED headlight to illuminate the circuit under test. The probes are powered directly by the Infiniium AutoProbe interface, eliminating the need for an additional power supply. The probes also come with a number of accessories that allow for easy connections to the circuit under test.

For more information about N2795A/96A/97A active probe, refer to the Keysight N2795A/96A/97A active probe data sheet literature number 5990-6480EN.

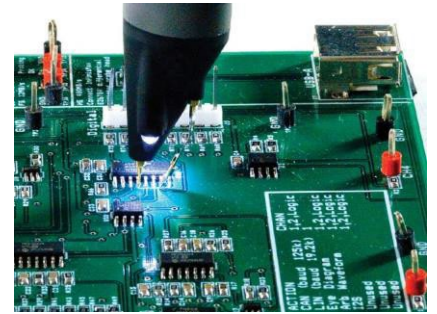

Characteristics for N2795A, N2796A, and N2797A active probes

	N2795A	N2796A	N2797A
Probe bandwidth ¹ (-3 dB)	1 GHz	2 GHz	1.5 GHz
Rise time	350 ps	175 ps	233 ps
System bandwidth	600 MHz (with Keysight's 600 MHz Infiniium oscilloscope)	1 GHz (with Keysight's 1 GHz Infiniium oscilloscope)	
Attenuation ratio (at DC)	10:1 ± 0.5%		
Input dynamic range	-8 to +8 V (DC or peak AC)		
Non-destructive input voltage	-20 to +20 V mains isolated		
Offset range	± 8 V	± 12 V	
DC offset error (output zero)	± 1 mV		
Low frequency accuracy	0.5% at 70 Hz, 1 Vpp		
Input resistance ¹	1 MΩ		
Input capacitance	1 pF		
Output impedance	50 Ω		

1. Denotes warranted electrical specifications after 20 minute warm-up. All others are typical.

Measurement plots

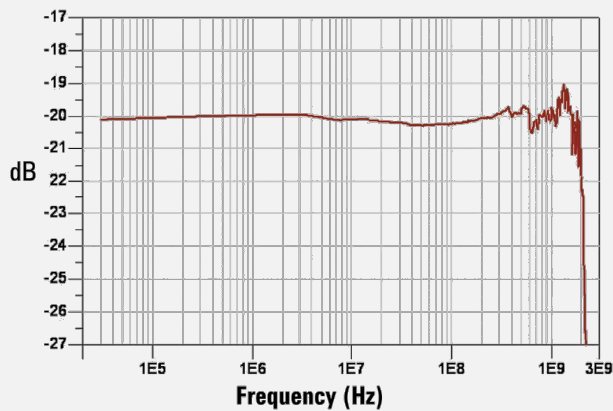

Frequency response of N2796A (V_{out}/V_{in})



Time domain step response of N2796A (with Keysight MSO9404A)

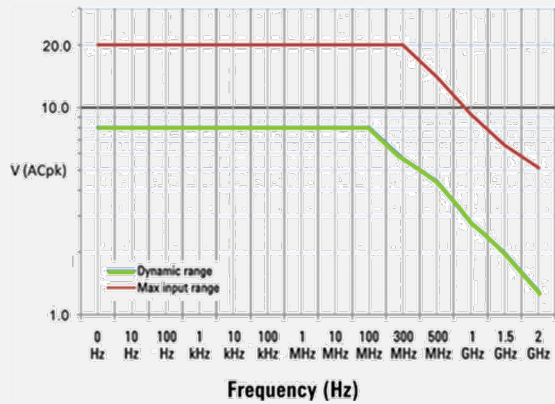

Voltage derating over frequency (N2796A)

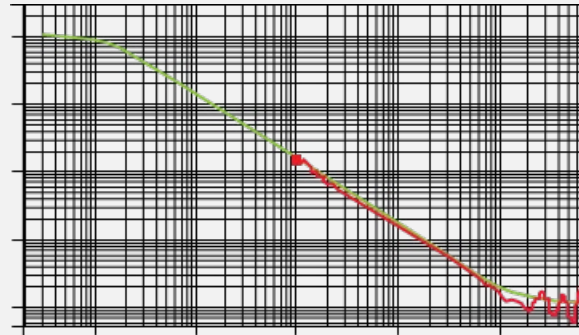

Input impedance over frequency (Red = measured, Green = model)

Ordering information	
Model number	Description
N2795A	1 GHz single-ended active probe
N2796A	2 GHz single-ended active probe
N2797A	1.5 GHz single-ended active probe

Reorderable accessories		
Model number	Description	Quantity
N4839A	Dual-lead socketed adapter, 6 cm	2
N4840A	Dual-lead solder-in adapter, 5 cm	2
N4841A	Dual-lead socketed adapter, 9 cm	2
N4842A	Dual-pin PCB header	2
N4843A	Solderable tips	10
N4844A	Right angle ground lead, 5 cm	2
N4845A	Ground blade	2
N4846A	Offset ground	2



N4839A



N4840A



N4841A



N4842A



N4843A



N4844A



N4845A



N4846A

Power Rail Probes — N7020A 2 GHz Power Rail Probe

- 2-GHz single-ended active probe for power rail noise measurement
- 1.1:1 attenuation ratio ensures low noise signal measurement
- ± 24 V of probe offset range enables effective elimination of DC component of a power supply



The N7020A power rail probe is a low noise, large offset range oscilloscope probe that enables users to measure small signals riding on top of DC power supplies.

- Low noise: The N7020A power rail probe is a 1:1 attenuation ratio active probe. As a general rule, the higher a probes attenuation ratio, the noisier the signal will be on the oscilloscope.
- Large offset range: The N7020A power rail probe provides ± 24 V of probe offset. This enables users to center the signal on screen while placing the oscilloscope at its maximum vertical sensitivity and zoom-in on the signal.
- Low DC loading: The N7020A power rail probe has 50 k Ω input impedance at DC, minimizing the probe's DC loading of the power rail.
- Large input dynamic range: The N7020A power rail probes ± 850 mV input dynamic range means that users can measure up to 850 mV deviations of their DC supplies. This is very useful for measuring programmable supplies like those used in micro-controller power saving modes.
- Supporting three connection options: pigtail solder head (2 GHz), SMA (2 GHz), browser (350 MHz).

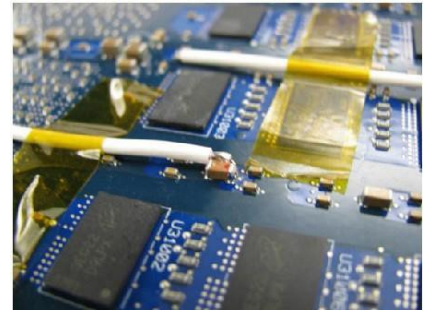

N7023A (included in the N7020A and orderable separately)

Characteristics and specifications	
Probe bandwidth (-3 dB)	2 GHz
Attenuation ratio	1.1:1
Offset range	± 24 V
Input impedance at DC	50 k Ω \pm 2%
• At > 1 MHz	50 Ω \pm 2%
Input dynamic range	± 850 mV about offset voltage, mains isolated
Probe noise	10% of oscilloscope noise
Included accessories	N7021A coaxial probe head (qty 3)
	N7022A SMA main cable
	N7023A browser kit
Output impedance	50 Ω
Compatible oscilloscopes	Infiniium S-Series or 9000 Series with software rev. 5.20 or higher

Power Rail Probes — N7024A 6 GHz Power Rail Probe

- 6 GHz single-ended active probe for power integrity measurements in high speed systems where fast switching loads and transients can lead to failure due to Power Supply Induced Jitter.
- 1.3:1 attenuation ratio maximizes the signal-to-noise ratio of the power rail measurements.
- ± 15 V probe offset range enables power integrity measurements of the power rails encountered in high speed systems.



The N7024A power rail probe is similar to the N7020A power rail probe in that they both were designed to provide the user the ability to zoom-in on their DC power supplies to accurately observe and measure the ripple, noise and transients riding on these supply outputs. The N7024A is for the engineer or technician who would like to use one oscilloscope for both their SI and PI measurements using Keysight's Infiniium oscilloscopes. The N7024A includes multiple connection options: SMA connection (6 GHz), N7021A pigtail coax (~6 GHz), N7033A fine pitch SMT browser (5 GHz), N7032A fine pitch SMT browser (4 GHz) and N7023A general purpose browser (350 MHz).

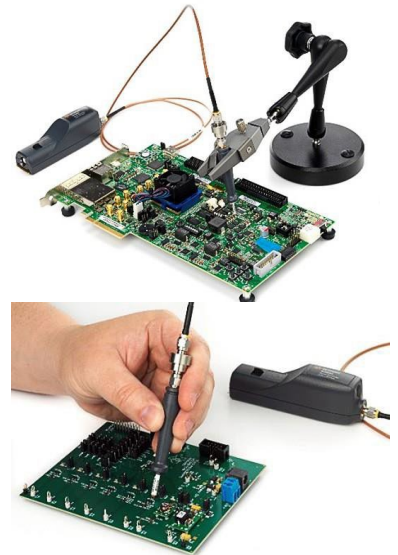

Characteristics and specifications	
Probe bandwidth (-3 dB) ¹	6 GHz
Attenuation ratio	1.3:1
Offset range	± 15.25 V
Input impedance	50 k Ω \pm 2% at DC 1, 50 Ω at > 1 MHz
Probe noise	30% of oscilloscope noise
Active signal range	± 600 mV about offset voltage, mains isolated
Output impedance	50 Ω
Included accessories (orderable separately)	N7021A Coaxial pigtail probe head (qty 3), 8" long
	N7022A Main cable, 48" long
	N7023A 350 MHz browser, 45" long
	N7032A 4 GHz browser for 0603 and 0805 packages (inch code)
	N7033A 5 GHz browser for 0201 and 0402 packages (inch code)
	1250-4403 Rotating SMA adapter
Extended temperature range	N7021A Main cable, N7022A Pigtail probe head: -40 to +85 °C
Compatible oscilloscopes	Infiniium S Series
	Infiniium 90000X, V, Z, or Q-Series (with N5442A)
	Infiniium 9000A, 90000A (with software ver 6.50 or higher)

1. Warranted specifications.

For more information about the N7020A and N7024A power rail probe, refer to the Keysight data sheet with the publication number 5992-0141EN.

High-Voltage Differential Probes — DP0001A

- High voltage differential probe for high voltage, high speed power device testing
- Measure up to 2 kV mains isolated, 1 kV CAT III and 400 MHz
- Unmatched electrical performance - flat frequency response and high CMRR

The DP0001A is a 400 MHz high voltage differential probe with 2 kV mains isolated or 1 kV CAT III rating designed for making accurate high-voltage power measurements required for testing today's WBG power devices, power converters or motor drives. Thanks to high bandwidth and low loading characteristics, the probe can accurately measure 1 kV transient pulse with as fast as 1.2 nsec of edge speed in modern switching power supplies. Also, high CMRR simplifies the measurement challenges found in noisy, high common-mode power electronics environments.



DP0001A high voltage differential probe

When used with an Infiniium oscilloscope, the probe supports an auto-switchable attenuation ratio that automatically sets the probe attenuation to the value necessary to make the dynamic range of the probe greater than or equal to the level required to measure the current input signal. A variety of accessories are shipped with this probe to suit various DUT connection scenarios and to make the connection to compact target devices possible.

The differential probes have a differential input resistance of 10 M Ω and low input capacitance of 2 pF to minimize circuit loading. The DP0001A is compatible with Keysight oscilloscopes with a 50- Ω AutoProbe interface, which configures the scope for the probe automatically.

When probing differential signals inside of environmental chambers at extreme temperatures, Keysight offers the N7013A extreme temperature extension kit. The N7013A is compatible with the DP0001A with a de-rated bandwidth of 70 MHz. The 70 cm long differential cable set and accessories can operate in temperatures ranging from -40 °C to +85 °C.

The probe is compatible with Infiniium MXR, S, 9000A and the high-end models including 90000X, V, Z, UXR <=33 GHz (with N5442A adapter).

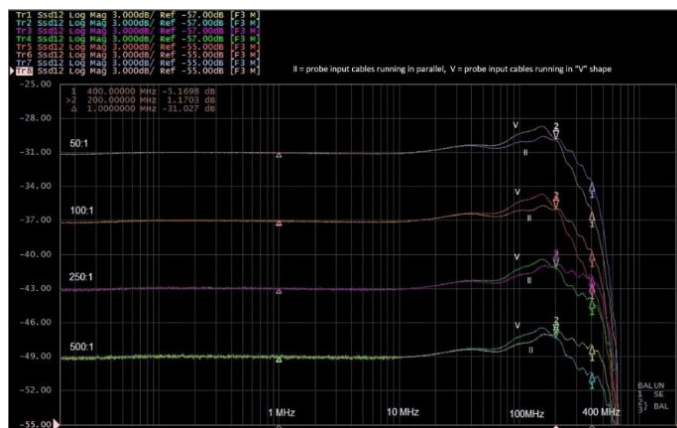

Frequency response of DP0001A



DP0002A Accessory kit for DP0001A

DP0001A characteristics and specifications

Characteristics	Value measured at the four supported attenuation modes				
	50:1	100:1	250:1	500:1	
Probe bandwidth (-3 dB)⁶					
	400 MHz	400 MHz	400 MHz	400 MHz	
Risetime (10% - 90%)					
Input voltage 50 V	1.2 nsec	1.2 nsec	875 psec	875 psec	
Input voltage 500 V	Not Applicable	Not Applicable	1.2 nsec	1.2 nsec	
Input voltage 1000 V	Not Applicable	Not Applicable	Not Applicable	1.2 nsec	
Maximum rated input voltage					
Mains isolated ¹ 	2000 Vrms				
	6000 V Overvoltage Transient				
CAT III ²	1000V				
Noise (Vrms ³ / spectral density) (Referred to the input)	180 mV / 9 µV/rt (Hz)	180 mV / 9 µV/rt (Hz)	280 mV / 14 µV/rt (Hz)	300 mV / 15 µV/rt (Hz)	
Typical Propagation Delay	10 ns				
Maximum Differential Input Voltage (DC + AC peak)	± 200 V	± 400 V	± 1000 V	± 2000 V	
Common mode voltage	± 2000 Vpk (1400 Vrms)				
DC gain accuracy ⁶	± 0.7 %	± 0.7 %	± 0.35 %	± 0.35 %	
Offset drift ⁴	150 µV / °C	150 µV / °C	40 µV / °C	40 µV / °C	
Input impedance					
Each input to ground	5 MΩ 4pF				
Differential input impedance	10 MΩ 2pF				
Input coupling of the oscilloscope ⁵	AutoProbe Interface 50 Ω				
Typical CMRR (dB)	DC	> 80	> 80	> 80	> 80
	100 kHz	75	70	65	60
	1 MHz	75	70	65	60
	10 MHz	70	58	54	50
	100 MHz	45	40	35	32
Standard accessories	Spring tips (qty 4), contact pins (qty 10), probe tip adapters (qty 2), safety alligator clips (qty 2), alligator plunger clips (qty 2), spade terminals (qty 2), pincer clips (qty 2), hook tip adapters (qty 2), coupler f-f (qty 1)				

1. Mains isolated is for measurements performed on circuits not directly connected to a mains supply.
2. Measurement category III is for measurements performed in the building installation.
3. Broadband Noise, Bandwidth 400 MHz.
4. Referred to the output of the probe.
5. Must be met to achieve the best performance and to avoid damage to the probe.
6. DC gain and bandwidth are the only warranted specifications. All others are typical.

DP0001A characteristics and specifications

Model number	Description
DP0001A	400 MHz high voltage differential probe
DP0002A	Accessory kit for DP0001A
N7007A	Extreme temperature probing kit for differential probe, probe BW derated to < 70 MHz with the extension cable used

High-Voltage Differential Probes — N2790A/91A/891A

- 25 to 800 MHz bandwidth
- Switchable attenuation
- Measure up to 1,400 V CAT II and 7 kV mains isolated

Oscilloscope users often need to make floating measurements where neither point of the measurement is at earth ground. Use N2790A, N2791A, or N2891A high voltage differential probes to make safe and accurate floating measurements with an oscilloscope. The N2790A, N2791A, and N2891A high voltage differential probes allow conventional earth-grounded Keysight oscilloscopes to be used for floating signal measurements.

Each probe offers user-selectable attenuation settings that make it highly versatile, allowing it to be used for a broad range of applications. The probe comes with probe tip accessories for use with small and large components in tight spaces.

The N2791A and N2891A are compatible with any oscilloscope with 1 M Ω BNC input. The N2791A and N2891A probe power is supplied by the included 4x AA batteries or the USB host port of the scope, or PC via a supplied USB power cable. The N2790A is compatible with the Keysight's AutoProbe interface where the probe power is supplied by the Keysight oscilloscope's probe interface. The N2790A is not compatible with 80000 and 90000 Series oscilloscope.

Most of today's electronic products must be tested in chambers under various environmental conditions, including extreme temperatures. The N7013A is a 70-cm long extreme temperature extension kit compatible with four of Keysight's medium- and high- voltage differential active probes including the N2790A, N2791A, N2792A, and N2818A. With the N7013A extension kit, the main body of the temperature-sensitive differential active probe can be placed outside of the environmental chamber, while the 70-cm long cable pair and connection adapters can be extended into the environmental chamber under extreme-temperature conditions ranging from -40 to +85 °C.



N2790A 100 MHz high voltage differential probe



N2790A measuring a power supply signal



N2791A 25 MHz high voltage differential probe



N2790A high voltage differential probe with N7013A extreme temperature extension kit



N7013A allows the use of differential probe inside an environmental chamber for extreme temperature testing



N2891A 70 MHz high voltage differential probe

Characteristics for N2790A, N2791A and N2891A differential probe

	N2790A	N2791A	N2891A
Bandwidth	100 MHz	25 MHz	70 MHz
Rise time	3.5 ns	14 ns	5 ns
Attenuation ratio	50:1/500:1	10:1/100:1	100:1/1000:1
Input impedance (between inputs)	8 M Ω /3.5 pF	8 M Ω /8 pF	100 M Ω /5 pF
Max input voltage to ground	\pm 1000 V (CAT II)	\pm 700 V at 100:1	\pm 7000 V at 1000:1
	\pm 600 V (CAT III)	\pm 70 V at 10:1	\pm 700 V at 100:1
Max input voltage between two inputs	\pm 1400 V at 500:1	\pm 700 V at 100:1	\pm 7000 V at 1000:1
	\pm 140 V at 50:1	\pm 70 V at 10:1	\pm 700 V at 100:1

High-Voltage Differential Probes — N2804A/05A

- 200 to 300 MHz bandwidth
- Measures up to 300 V differential, 1 kV common mode
- Ideal for high speed power measurements

The N2804A and N2805A differential probes provide the superior general-purpose differential signal measurements that are required for high-speed power measurements such as measuring characteristics of switching power devices, DC-DC converters, or class D amplifiers, vehicle bus measurements, and high-speed digital system designs.

The N2804A 300-MHz differential probe offers 100:1 attenuation ratio, allowing it to be used adequately for high voltage signal measurements. The differential probe has a differential input resistance of 4 M Ω and low input capacitance of 4 pF to minimize circuit loading. The probe comes with a pair of extension leads (30 cm long) with a damping resistor built in to damp out the in-band resonance and provide flat frequency response even while using the extension leads and probe tip accessories.

The N2805A is a 200-MHz differential probe designed to provide superior differential signal measurements with long cable length (5 m), making it ideal in an environment where extended cable length is required. This probe comes with an extensive set of probe tip accessories for use with small and large components in tight spaces.



N2804A 300 MHz differential probe



N2805A 200 MHz differential probe

	N2804A	N2805A
Bandwidth	300 MHz (without extension leads)	200 MHz
	120 MHz (with extension leads)	
Attenuation ratio	100:1	50:1
DC gain accuracy	± 1%	± 1%
Input impedance (between inputs)	4 MΩ / 4 pF	4 MΩ / 4 pF
Max input voltage (between two inputs)	± 300 V (DC+ peak AC) and ± 200 Vrms	± 200 V (DC+ peak AC) and ± 200 Vrms CAT II
Max input voltage	± 300 V (DC+ peak AC) and ± 200 Vrms CAT II	± 500 V (DC+ peak AC) and ± 500 Vrms mains isolated
	± 1000 V (DC+ peak AC) and ± 1000 Vrms, mains isolated	± 300 V (DC+ peak AC) and ± 200 Vrms CAT II
Cable length	1.2 m	5 m
Compatible Infiniium oscilloscopes	Infiniium S-Series, 9000, 90000 Series with software 5.2 or higher	

General Purpose Differential Probes — N2818A/19A

The N2818A 200-MHz and N2819A 800-MHz differential probes provide the superior general-purpose differential signal measurements required for today's high-speed power measurements, vehicle bus measurements, and digital system designs.

The N2818A and N2819A probes offer a 10:1 attenuation setting and high input resistance and low input capacitance to minimize circuit loading.

Both probes are compatible with AutoProbe interface with 50 Ω BNC input.



N4853A variable pitch browser

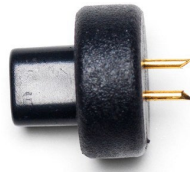

N4854A DC blocking capacitor



N2818A 200-MHz, 20-V differential probe



N2819A 800-MHz, 15-V differential probe

Characteristics for N2818A and N2819A differential probes

	N2818A	N2819A
Bandwidth	200 MHz	800 MHz
Rise time	1.75 ns	437 ps
Attenuation ratio	10:1	10:1
Probe loading (between inputs)	1 MΩ / 3.5 pF	200 kΩ / 1 pF
Max input voltage to ground	± 60 V mains isolated	± 40 V mains isolated
Max input voltage between two inputs	± 20 V	± 15 V

Ordering information for Keysight differential probes and power supply

Model number	Description
N2790A	100-MHz, 1.4 kV differential probe with AutoProbe interface
N2791A	25-MHz, 700-V differential probe
N2818A	200-MHz, 20-V differential probe with AutoProbe interface
N2819A	800-MHz, 15-V differential probe with AutoProbe interface
N2891A	70-MHz, 7,000-V differential probe
N4853A	Variable pitch browser for N2819A
N4854A	DC blocking capacitor for N2819A
N2804A	300-MHz high voltage differential probe
N2805A	200-MHz high voltage differential probe with extended cable length
N2816A	Probe tip accessory kit for N2804A including 2 alligator clips, 2 pincer clips, and 1 extension lead (30 cm)
N2817A	Probe tip accessory kit for N2805A including 2 alligator clips, 2 hook clips, 2 pincer clips, and 2 browser tips

AC/DC Current Probes — 1146B

The 1146B AC/DC current probe provides accurate display and measurement of currents from 100 mA to 100 Arms, DC to 100 kHz, without breaking into the circuit. A battery level indicator and overload indicator help ensure proper readings. It connects directly to the scope through a 2-m coaxial cable with an insulated BNC. This probe works with any 1 M Ω input oscilloscope.

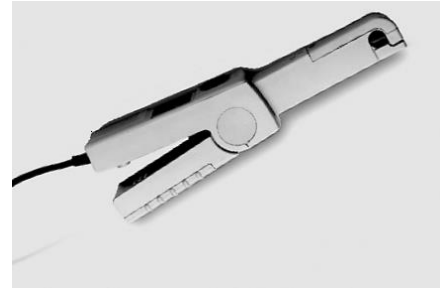

1146B 100 mA to 100 Arms, DC to 100 kHz probe

Operating characteristics of the 1146B current probe

	1146B
Bandwidth ¹	DC to 100 kHz (–3 dB)
Current range ¹	100 mV/A: 100 mA to 10 A peak
	10 mV/A: 1 to 100 A peak
Output signal	1000 mV peak max
AC current accuracy ¹	
• Range	100 mV/A (50 mA to 10 A peak)
• Accuracy	3% of reading \pm 50 mA
• Range	10 mV/A (500 mA to 40 A peak)
• Accuracy	4% of reading \pm 50 mA
• Range	10 mV/A (40 A to 100 A peak)
• Accuracy	15% max at 100 A
Noise	Range 10 mV/A: 480 μ V
	Range 100 mV/A: 3 mV
Insertion impedance	0.01 Ω (50/60 Hz)
Maximum working voltage	600 Vrms CAT II or 300 Vrms CAT III
Maximum common mode voltage	600 Vrms CAT II or 300 Vrms CAT III
Influence of adjacent conductor	< 0.2 mA/A AC
Influence of conductor position	0.5% of reading at 1 kHz in jaw
Battery	9 V alkaline (NEDA 1604A, IEC 6LR61)
Low battery	Green LED on when \leq 6.5 V
Battery life	55 hours typical

1. Characteristics are specified performance. Others are typical characteristics.

Note: Reference conditions: 23 \pm 5 $^{\circ}$ C, (73.4 \pm 4.1 $^{\circ}$ F), 20 to 75% relative humidity, DC to 1 kHz, probe zeroed, 1-minute warmup, batteries at 9 V + 0.1 V, external magnetic field < 40 A/m, no DC component, no external current carrying conductor, 1 M Ω /100 pF load, conductor centered in jaw.

Ordering information

Model number	Description
1146B	100-kHz current probe

AC/DC Current Probes — 1147B/N2893A/N7026A

The 1147B/N2893A/N7026A is a wide bandwidth, DC to 50-MHz/100-MHz/150-MHz current probe. The probes offer a flat frequency response across the entire bandwidth, low noise (< -2.5 mArms for 1147B/N2893A, 250 μ Arms for N7026A) and low circuit insertion loss.

These three current probes are compatible with the AutoProbe interface, which completely configures the oscilloscope for the probe when used with the Infiniium S-Series or 9000 Series scope (1 M Ω input). Probe power is provided by the scope, so there is no need for an external power supply unless you would like to measure at the highest current in the range for N7026A. The N2893A and N7026A uniquely provide an auto demagnetization and offset elimination feature when used in conjunction with an InfiniiVision or Infiniium scope.

The N7026A is a high sensitivity clamp-on current probe for measuring up to 150 MHz of AC/DC current with significantly higher sensitivity when compared to a conventional Keysight clamp-on current probe. This probe provides sensitivity down to 1 mA/div for measurement of current from the mA range up to a continuous current of 30 Arms and peak current of 40 A. The N7026A, when used with an InfiniiVision or Infiniium oscilloscope, provides highly-accurate, low current waveforms for improved debug and analysis.



1147B 50-MHz current probe with AutoProbe interface



N2893A 100-MHz current probe with AutoProbe interface



N7026A 150-MHz high sensitivity currentprobe with AutoProbe interface

Ordering information

Model number	Description
1147B	50-MHz current probe with AutoProbe interface
N2893A	100-MHz current probe with AutoProbe interface
N7026A	150-MHz high sensitivity current probe with AutoProbe interface

Characteristics of the 1147B/N2893A/N7026A current probes

	1147B/N2893A	N7026A
Bandwidth (–3 dB)	DC to 50 MHz (1147B) DC to 100 MHz (N2893A)	DC to 150 MHz
Rise time (calculated, 10% to 90%)	7 nsec (Tr = 0.35/BW)	2.67 nsec (Tr = 0.4/BW)
Maximum current (continuous)	15 Apeak, 15 ADC, 10 Arms	30 ADC, 30 Arms (with external power adapter) 5 ADC, 5 Arms (without external power adapter)
Maximum peak current (non-continuous) (for pulse-widths ≤ 10 μs)	30 Apeak	40 Apeak (when using external AC power adapter) 15 Apeak (without using external power adapter)
Output voltage rate	0.1 V/A	1 V/A and 0.2 V/A, automatically switched by the oscilloscope
Minimum oscilloscope vertical scale	10 mA/div	1 mA/div
Amplitude accuracy	± 1% rdg, ± 10 mA (DC or 45 to 66 Hz, rated current)	± 1% rdg. ± 5 mA to 30 Arms (including calibration scale factor of oscilloscope measured at DC or 45 to 66 Hz.)
Noise	≤ 2.5 mArms (for 20 MHz bandwidth measuring instrument)	≤ 250 μArms (for 20 MHz bandwidth measuring instrument)
Temperature coefficient for sensitivity	± 2% or less (within a range of 0 to 40 °C or 32 to 104 °F)	
Effect of external magnetic fields	Equivalent to a maximum of 20 mA (in a DC to 60 Hz, 400 A/m magnetic field)	
Maximum rated power	3 VA (with rated current)	
Diameter of measurable conductors	5 mm dia. (0.2 in dia.)	
Probe interface	AutoProbe interface (1 MΩ terminated)	
Cable lengths	Approx. 1.5 m (59.0 in)	
Maximum number of probes supported	4	2 (9000), 4 (S-Series)

Note: Uniquely with Infiniium MXR/EXR oscilloscopes, the 1147B, N2893A and N7026A provide larger input current ranges going beyond the standard maximum current ranges specified with other Keysight oscilloscopes and the flexibility to use the N7026A for measuring high current without using an external AC power adapter at all.

	MXR/EXR main channels ¹	MXR/EXR secondary channels ²
1147A/B, N2893A	DC: 30 Adc,	DC: 15 Adc,
	Continuous AC: 30 ARMs, 42 Apeak	Continuous AC: 10 ARMs, 15 Apeak
	Non-continuous AC: 50 Apk	Non-continuous AC: 30 Apk
N7026A	DC: 30 Adc	DC: 30 Adc
	Continuous AC: 30 ARMs	Continuous AC: 30 ARMs
	Non-continuous AC: 40 Apk (without using an external AC power adapter)	Non-continuous AC: 40 Apk (without using an external AC power adapter)

1. Main channels are channel 1-4 for MXR/EXR 4 and 8 channel models.
2. Secondary channels are channel 5-8 for MXR/EXR 8 channel models.

AC/DC Current Probes — N2780B/81B/82B/83B/83L

The N2780B/L Series current probes are high bandwidth, active current probes, featuring flat bandwidth, low noise (2.5 mArms) and low circuit insertion loss. Compatible with any oscilloscope with a 1 M Ω BNC input, the N2780B/L Series current probes offer accurate and reliable solution for measuring DC and AC currents. Because of the split-core design, they can easily clip on and off of a wire in conjunction with the power supply (model N2779A), this probe can be used with any oscilloscope with a high-impedance BNC input. The companion power supply N2779A (3 x 12 \pm VDC output) lets you connect up to any three N2780B-83B/83L current probes to a single power supply.

The N2783L 80 MHz current probe offers a 5-m long cable, which allows you to reach DUTs over long distances very easily. Other than the bandwidth performance, the N2783A and N2783L have the same electrical performance. The N2783L also requires the N2779A power supply to power the probe.

Ordering information

Model number	Description
N2780B	2-MHz current probe
N2781B	10-MHz current probe
N2782B	50-MHz current probe
N2783B	100-MHz current probe
N2779A	Power supply for the N2780B/81B/82B/83B/83L current probes
N2783L	80-MHz current probe with 5 m cable



N2783L with 5 m long cable



N2780B Series current probes with N2779A power supply

Operating characteristics of the N2780B/L Series current probes

	N2780B/L Series
Bandwidth (–3 dB)	DC to 2 MHz (N2780B)
	DC to 10 MHz (N2781B)
	DC to 50 MHz (N2782B)
	DC to 100 MHz (N2783B)
	DC to 80 MHz (N2783L)
Maximum current (continuous) ²	500 A (N2780B)
	150 A (N2781B)
	30 A (N2782B/N2783B/N2783L)
Maximum peak current (non-continuous) ²	700 A peak (N2780B)
	300 A peak (N2781B)
	50 A peak (N2782B/N2783B/N2783L)
Output voltage rate	0.01 V/A (N2780B/N2781B)
	0.1 V/A (N2782B/N2783B /N2783L)
Amplitude accuracy ¹	± 1.0% rdg ± 500 mA (N2780B)
	± 1.0% rdg ± 100 mA (N2781B)
	± 1.0% rdg ± 10 mA (N2782B)
	± 1.0% rdg ± 10 mA (N2783B/N2893L)

1. The amplitude accuracy specification is guaranteed at 23 °C ± 3 °C (or 73 °F ± 5 °F).

2. Insulated conductor must be used.

Rogowski Coil AC Current Probes — N7040A/41A/42A

- Easy-to-use clip-around coil enabling current measurement in confined space
- Measure AC current up to 3,000 Apk (with N7040A)
- Up to 30 MHz bandwidth (with N7041A/42A)

The N7040A Series Rogowski coil current probes are designed for measuring AC currents ranging from a few 100 milliamps to 3,000 A from 3 Hz to > 30 MHz.

The probes have a thin, lightweight, flexible and simple-to-use clip-around Rogowski coil that enables current measurement in the most difficult-to-reach parts and confined spaces of a circuit under test and can measure large AC current without increase in transducer size.

The N7040A Series is ideal for measuring AC current in the presence of large DC current and can be used to design, debug and troubleshoot power semiconductor circuits, power supplies, inverters and motor drives.

These probes come with an AC power adapter and 4x AA batteries to power the probe and can be used with any oscilloscope with 1 Mohm BNC interface.



	N7040A	N7041A	N7042A
HF bandwidth (-3 dB)	23 MHz	30 MHz	30 MHz
LF bandwidth (-3 dB)	3 Hz	12 Hz	9.2 Hz
Peak current (Apk)	3,000 Apk	600 Apk	300 Apk
Sensitivity	2 mV/A (500:1)	10 mV/A (100:1)	20 mV/A (50:1)
Max noise (mVpp)	8 mVpp	10 mVpp	15 mVpp
Droop (%/msec)	2.8%/msec	11%/msec	9%/msec
Peak di/dt (kA/μsec)	80 kA/μsec	40 kA/μsec	20 kA/μsec
Absolute max peak di/dt (kA/μsec)	100 kA/μsec	100 kA/μsec	70 kA/μsec
Absolute max rms di/dt (kA/μsec)	1.2 kA/μsec	1.2 kA/μsec	1.2 kA/μsec
Accuracy	Calibrated to ± 0.2% of reading with conductor central in the coil loop		
Variation in conductor position	± 2% of reading		
Linearity	0.05% of reading		
DC offset	± 3 mV max at 25 °C		
Temperature range	Coil and cable at -40 to +125 °C		
Coil voltage	5 kV peak	5 kV peak	1.2 kV peak
Coil length (circumference)	200 mm	100 mm	80 mm
Coil cross-section (diameter)	4.5 mm	4.5 mm	1.7 mm
Cable length	4 m (connecting cable coil to integrator box)	2.5 m (connecting cable coil to integrator box)	
Total cable length	4.5 m (4 m input cable + 0.5 m BNC cable to scope)	3 m (2.5 m input cable + 0.5 m BNC cable to scope)	
Probe output	Terminated into 1 MΩ BNC input of oscilloscope		
Probe power	4x AA batteries and AC power adapter (included)		

High-Sensitivity Current Probes — N2820A/21A

- Measure AC/DC currents as low as 100 nA (with the N2825A user defined head used)
- Ideal for capturing and analyzing low level current flow in the DUT to characterize sub-circuits or measure current consumption of battery- powered devices or integrated circuits
- Simultaneous high- and low-gain views of the current waveform for more precise wide dynamic range measurement (with N2820A)

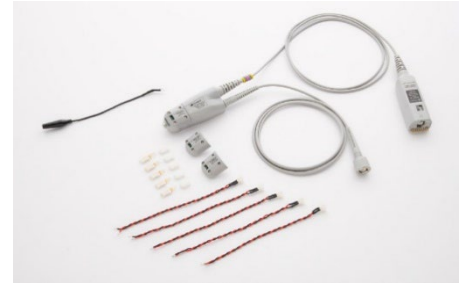

N2820A high-sensitivity 2-channel current probe

As modern battery-powered devices and integrated circuits become more green and energy efficient, there is a growing need to make high-sensitivity, low-level current measurements to ensure the current consumption of these devices is in acceptable limits. The N2820A high-sensitivity probe is engineered to make high-dynamic-range, high-sensitivity measurements to meet today's challenging current measurement needs.

The ultra-sensitive N2820A AC/DC current probe can support measurements from 100 nA to 120 A on Keysight oscilloscopes. The N2820A interface uses a make-before-break (MBB) connector, allowing you to quickly probe multiple locations on your DUT without having to solder or unsolder the leads. The N2820A 2-channel current probe connects to two oscilloscope channels to provide simultaneous low- and high-gain views for wider dynamic range measurement, while the N2821A 1-channel current probe provides one user-selectable view at a time.

Use an area-under-the-curve measurement (Charge) on Infiniium oscilloscopes to easily calculate the integrated current consumptions over time in Ah.

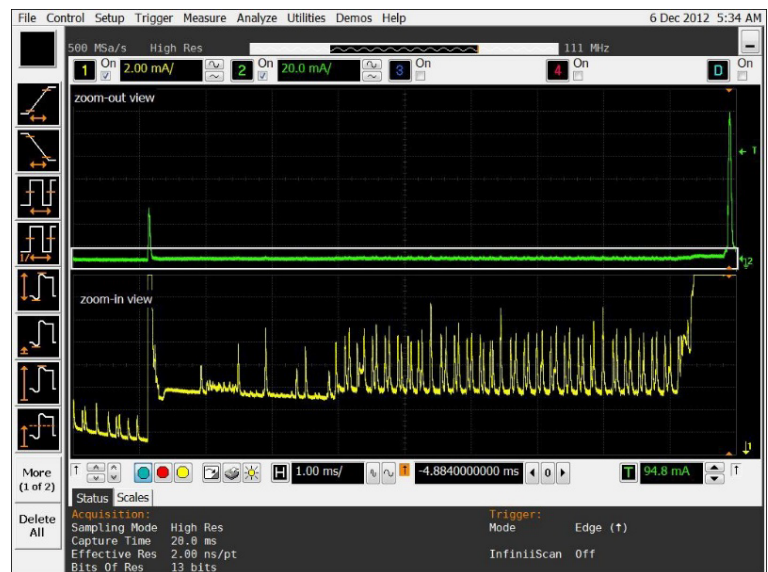

The N2820A 2-channel current probe connects to two oscilloscope channels to provide simultaneous low- and high-gain views for wider dynamic range measurement

Probe characteristics and specification	
Bandwidth (–3 dB)	Zoom-out channel: DC to 3 MHz
	Zoom-in channel: DC to 500 kHz
Rise time (Tr = 0.35/bandwidth, 10 to 90%)	Zoom-out channel: < 0.116 µs
	Zoom-in channel: < 0.7 µs
Minimum measurable current ¹	250 µA (with N2822A 20 mΩ, 500 mW)
	50 µA (with N2824A 100 mΩ, 500 mW)
	5 mA (with N2825A user-defined 1 mΩ, 500 mW)
	100 nA (with N2825A user-defined 1 kΩ, 500 mW)
Maximum measurable current	5 A (with N2822A 20 mΩ, 500 mW)
	2.2 A (with N2824A 100 mΩ, 500 mW)
	5 A ² (with N2825A user-defined 1 mΩ, 500 mW)
	1.2 mA ² (with N2825A user-defined 1 kΩ, 500 mW)
	120 A (with N2825A user-defined 1.5 mΩ installed, 20 W)
DC amplitude accuracy	± 3% or 10 µA (whichever is greater)
Gain ³	Zoom-in channel: 300 ± 3%
	Zoom-out channel: 1.97 ± 3%
Max input voltage	± 12 V
Output impedance	1 MΩ
Standard accessories	1 each 20 mΩ resistor sensor head
	1 each 100 mΩ resistor sensor head
	1 each user-defined resistor sensor head
	5 each twisted leads (22 AWG) with sockets
	5 each twisted leads (22 AWG) without sockets
	5 each MBB headers
	5 each MBB receptacles
	1 each ground lead
	1 each screw driver
	1 each passive cable (with N2820A only)
1 each User Guide manual (English)	
Compatible InfiniiVision oscilloscopes	Infiniium 9000A/H with software version 4.2 or higher
	Infiniium S Series with software version 5.0 or higher

1. Vsupply is equal to 5 V, solder attached.

2. Max current varies with max resistor power rating. The examples in the table assume 500 mW power rating.

3. Denotes warranted specification after 20-minute warm up. All others entries in the table are characteristics.

Ordering information

Model numbers	Descriptions
N2820A	High-sensitivity 2-ch current probe
N2821A	High-sensitivity 1-ch current probe
Replacement part numbers	
N2822A	20 mΩ resistor tips
N2824A	100 mΩ resistor tips
N2825A	User-defined resistor tips
N2826A	Replacement wires (15.5 cm, 22 AWG bare wires) (qty 5)
N2827A	Passive cable (for N2820A secondary channel)
N2828A	Replacement MBB (make-before-break) headers (qty 5)
N2829A	Replacement MBB (make-before-break) receptacles and 15.5 cm, AWG 22 socketed wires (qty 5 each)

For more details about the N2820A/21A high sensitivity current probe, check out the product data sheet with the literature number, 5991-1711EN.

General Purpose Passive Probes — N2870A-76A

- Small 2.5 mm probe tip
- Replaceable spring-loaded probe tip for reliable contact
- 1:1, 10:1, 20:1, and 100:1 attenuation ratios with auto probe ID readout
- Wide compensation range for a variety of scope inputs
- Comes with various probe tip accessories
- Optional probe accessory kits
- N2873A, 500 MHz, 10:1 probe
- Ships with the S and 9000 Series Infiniium oscilloscope



N2873A 500 MHz passive probe with standard accessories

The N2870A Series passive probe family sets new standards in high performance probing of up to 1.5 GHz bandwidth. These general purpose probes and accessories offer high quality measurements at a very reasonable price.

Compact 2.5-mm probe head diameter, low input capacitance, and various fine-pitch probe tip accessories make the Keysight N2870A Series passive probes ideal for probing densely populated IC components or surface-mount devices used in today's high-speed digital applications. The sharp probe tip is spring loaded to help engineers keep the probe from slipping off the device under test. Insulating IC caps keep the small probe.

tip centered on the IC lead and keep it from shorting adjacent leads. Standard flat blade ground connector and self-adhesive copper ground pads help reduce ground inductance, while offering easy ground access. Optional probe tip accessories provide specialized capabilities for demanding applications.

The N2873A 500 MHz passive probe ships with Keysight's 9000 and S-Series Infiniium oscilloscope.

Electrical characteristics

Model number	Bandwidth (–3 dB)	Attenuation ratio ¹	Input C	Input R ¹ (Scope and probe)	Max input voltage (AC RMS)	Scope input coupling	Scope comp range
N2870A	35 MHz	1:1	39 pF (+oscilloscope)	1 MΩ	55 V CAT II	1 MΩ	—
N2871A	200 MHz	10:1	9.5 pF	10 MΩ	400 V mains isolated 300 V CAT II	1 MΩ	10 to 25 pF
N2872A	350 MHz	10:1	9.5 pF	10 MΩ	400 V mains isolated 300 V CAT II	1 MΩ	10 to 25 pF
N2873A	500 MHz	10:1	9.5 pF	10 MΩ	400 V mains isolated 300 V CAT II	1 MΩ	10 to 25 pF
N2874A	1.5 GHz	10:1	1.8 pF	500 Ω	8.5 V mains isolated	50 Ω	—
N2875A	500 MHz	20:1	5.6 pF	20 MΩ	400 V mains isolated 300 V CAT II	1 MΩ	7 to 20 pF
N2876A	1.5 GHz	100:1	2.2 pF	5 kΩ	21 V mains isolated	50 Ω	—

1. Denotes warranted specifications, all others are typical. Attenuation ratio = ± 2% at DC, Input R (probe only, N2870A excluded) = ± 1%.

Common to all

Probe ID readout: Compatible with Keysight's InfiniiVision and Infiniium Series oscilloscopes

Mechanical characteristics

- Weight (probe only): 48 g
- Cable length: 1.3 m
- Ground sleeve diameter: 2.5 mm

Environmental characteristics temperature

- Operating: 0 to +50 °C
- Non-operating: –40 to +70 °C

Altitude

- Operating: 2,000 m (6,561 ft)
- Non-operating: 15,000 (49,212 ft)

Humidity

- Operating: 80% room humidity for temperatures up to 31 °C, decreasing linearly to 40% at 50 °C non-condensing

Pollution degree: 2

Optional accessory kits

Model number	Description
N2877A	Deluxe accessory kit
N2878A	General purpose accessory kit
N2879A	Fine pitch accessory kit
N2885A	PCB socket adapter kit
N4829A	Probe tip kit (rigid and spring loaded), qty 10 each
N4831A	Sprung hook tip, qty 2 (for N2870A/71A/72A/73A/75A)
N4836A	Dual-lead adapter 2.5 mm, 6.5 cm, qty 2
N4837A	Ground lead 15 cm, qty 2
N4838A	2.5 mm ground spring, qty 2
N4863A	2.5 mm probe tip-to-PCB adapter, horizontal, qty 2
N4864A	2.5 mm probe tip-to-PCB adapter, vertical, qty 2



N4829A



N4831A



N4836A



N4837A

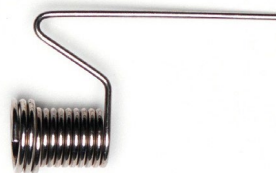

N4838A



N4863A



N4864A

Standard accessories

	N2871A, N2872A, N2873A, N2875A	N2870A	N2874A, N2876A
Rigid probe tips, qty 2	•	•	•
Spring-loaded probe tips, qty 2	•	•	•
Sprung hook 2.5 mm	•	•	
Short sprung hook 2.5 mm			•
Ground blade 2.5 mm with 2 copper pads	•	•	•
IC cap 2.5 to 0.5 mm green	•	•	•
IC cap 2.5 to 0.65 mm blue	•	•	•
IC cap 2.5 to 0.8 mm gray	•	•	•
IC cap 2.5 to 1.0 mm brown	•	•	•
IC cap 2.5 to 1.27 mm black	•	•	•
Insulating cap 2.5 mm	•	•	•
Protection cap 2.5 mm	•	•	•
BNC adapter 2.5 mm	•	•	•
Ground spring 2.5 mm	•	•	•
Ground lead 15 cm	•	•	•
Trimmer tool	•		
Color coded rings 3x4	•	•	•
User's Guide manual	•	•	•

Other replacement parts

Part number	Description
0960-2907	Short spring hook 2.5 mm for N2874A and N2876A 1.5 GHz passive probe
0960-2908	10 self-adhesive copper-pads 2X2 cm for N2870A Series probes

For other re-orderable accessories for N2870A-76A passive probes, visit the product Web page at www.keysight.com/find/probes.

Extreme Temperature Passive Probe — N7007A

Features and specifications

- Wide operating temperature range of -40 to +85 °C for extreme temperature environmental chamber testing
- 400 MHz bandwidth (-3 dB)
- High impedance (10 MΩ at DC) input
- Wide input range: 1 kV CAT II, 600V CAT III
- Includes hook tip adapters (x2), ground leads (x2), and spring ground tip (x1)

The N7007A 400 MHz passive probe is a low-cost, high impedance passive probe with rugged probe tips for environmental chamber testing from -40 to +85 °C range. Its large input impedance (10 MΩ at DC) and wide input voltage range (1,000 Vdc + peak AC CATII) makes the probe ideal for a broad range of general purpose extreme temperature applications.

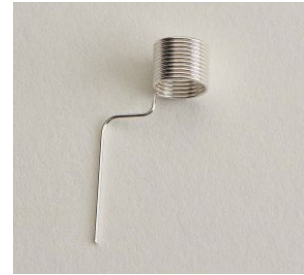

N7006A spring ground



N7007A passive probe

Key characteristics

	N7007A
Bandwidth	400 MHz (with spring ground), 70 MHz (with ground lead)
Attenuation ratio	10:1
Input impedance (at DC)	10 MΩ//15.5 pF (when terminated into 1 MΩ)
Oscilloscope compensation range	6 to 18 pF
Operating temperature range	-40 to +85 °C
Operating humidity range	< 90% at 40 °C non-condensing
Cable length	2 m
Max input range	1 kV CAT II, 600V CAT III

Ordering information

N7007A	10:1 400 MHz extreme temperature passive probe
N7006A	Spring ground for N7007A
N7008A	Hook tip adapter for N7007A
N7009A	Ground lead for N7007A



N7008A hook tip adapter



N7009A ground lead

High Voltage Passive Probes — 10076C

- Ideal for measuring up to 3.7 kVpk
- Up to 500 MHz bandwidth
- 100:1 attenuation ratio

The Keysight 10076C 3.7 kVpk 100:1 passive probe gives you the voltage and bandwidth you need for making high-voltage measurements. Its compact design makes it easier to probe today’s small power electronics components and its rugged construction means it can withstand rough handling without breaking.

The 10076C is compatible with any oscilloscope with 1 MΩ BNC input. For use with the Infiniium 90000 Series scope, use the E2697A high impedance probe adapter. For use with the Infiniium 90000 X- and 90000 Q-Series scope, use the N5449A high impedance probe adapter.



10076C high voltage passive probe



10077A accessory kit for 10076B/C



N2789A spring ground tip for 10076B/C

Operating characteristics the 10076C 100:1 passive probe

	10076C
Bandwidth	500 MHz (–3 dB)
Rise time (calculated)	< 0.7 ns
Attenuation ratio	100:1
Input resistance	66.7 MΩ (when terminated into 1 MΩ)
Input capacitance	Approx 3 pF
Maximum input	3700 Vpk mains isolated, 1000 Vpk CAT II
Compensation	6 to 20 pF range
Probe readout	Yes
Cable length	1.8 m

Ordering information

Model number	Description	Quantity
10076C	High-voltage probe: includes one retractable hook tip, one ground-bayonet, one IC probing tip, one alligator ground lead, and a compensation screwdriver	1
10077A	Accessory kit for 10076B/C including one retractable hook pin, one ground lead, one insulation cap, two measuring pin, and eight ID tags	1
N2789A	Spring ground tip for 10076B/C	1

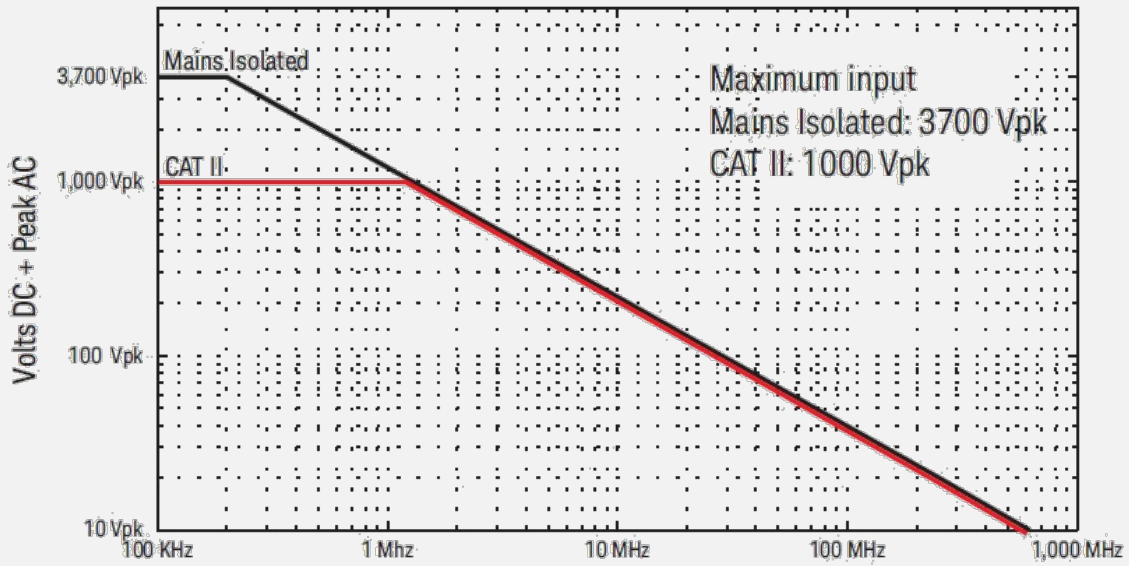

10076C derating curve

Accessories — Mixed Signal Oscilloscope Logic Probes

- Compatible with all 40-pin logic probe
- Flying leads offer flexibility and convenience

MSO probes offer great value and performance

The logic probe for the MSO9000A and S-Series mixed signal oscilloscopes (MSOs) are the same one used with Keysight industry leading high-performance logic analyzers. This means we can offer the best performance, great value and access to the industry's broadest range of logic probing accessories.

The Infiniium MSO9000A and S-Series come with a 16-channel logic probe kit containing a 40-pin (F) to 40-pin (F) logic probe cable assembly (or external digital cable), 2-inch ground leads (qty 5), SMT IC clips (qty 20) and a 16-channel flying lead probe tip assembly. The standard cable gives the MSO the standard 40-pin female input connector that many Keysight logic analyzers have. With this cable, a user can connect a wide variety of logic analyzer probes such as Mictor, Samtec, and Soft Touch probes. For information on these probes, see Probing Solutions for Logic Analyzers - Data Sheet (with Keysight literature number 5968-4632E).

For optimal signal fidelity, connect ground at each logic probe, in addition to taking a common ground to all eight signals via a separate ground connector on the probe pod.



SMT IC clip
(part number 5090-4833)

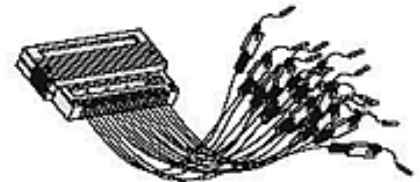

Sixteen-channel probe lead set
(part number 01650-61609)

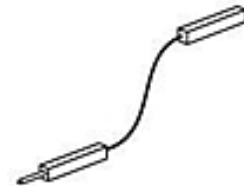

Ground leads contain 5 short ground leads (part number 5959-9334)



External digital cable
(part number 54904-61622)

Characteristics for Keysight Infiniium MSOlogic probe kit	
Analog bandwidth of cable and flying leads	400 MHz
Input resistance	100 k Ω \pm 2%
Input capacitance	8 pF at the tip

Kit parts supplied (Order individual partnumbers as shown right.)	
16-channel probe set leads	x1
Ground leads	x5
SMT IC clips	x20
External digital cable	x1

The 9000 and S Series MSO digital channels were architected to be compatible with a wide variety of probing accessories developed over 20 years for logic analyzers. There is a good chance that the logic analyzer accessories you already own work with your MSO. With the standard 40-pin cable that comes with your MSO, the MSO accepts numerous logic analyzer accessories including:

- E5346A 34-channel Mictor connector probe
- E5385A 34-channel Samtec connector
- E5383B 16-channel flying lead set 01650-63203 16-channel termination adapter (also available as a bundle of both the termination adapter and the 40-pin cable with PN 10085-68701)
- E5404A 34-channel soft touch pro connectorless probe
- E5394A 34-channel soft touch connectorless probe
- E5396A 16-channel soft touch connectorless probe
- Any other accessory that connects to a logic analyzer via a 40-pin cable

For logic accessories of greater channel width than MSO digital channels (> 16 channels), there are two use models.

- Route up to 16 signals to the probe and do not use the additional probe channels.
- Route up to 32 signals to the probe and measure half of them at a time. Simply plug the 40-pin cable to the other side of the probe to see the other half of the signals.

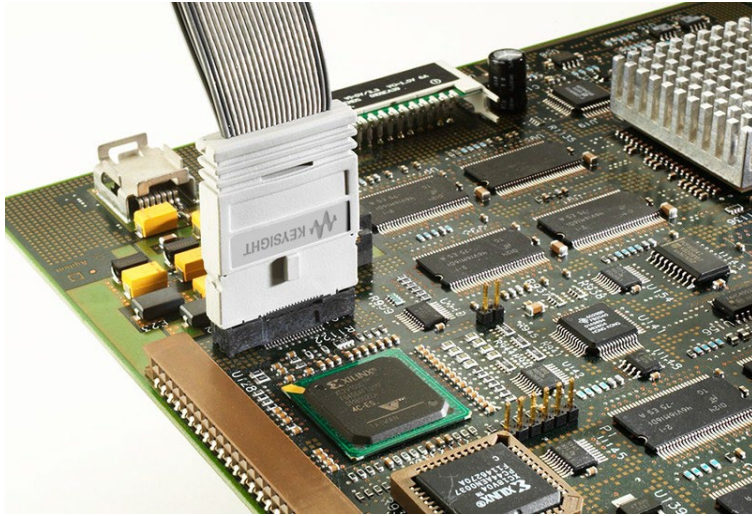

E5346A 34-channel Mictor connector probe



E5396A 16-ch (half size) soft touch connector less probe



E5385A 34-channel Samtec connector probe

Accessories — N2744A T2A Probe Interface Adapter

- Enables Tektronix TekProbe-BNC level 2 probes to connect to Keysight's AutoProbe interface on InfiniiVision 3000X, 4000X, 6000X, 5000, 6000, 7000, and Infiniium 9000, 90000, and S-Series oscilloscopes
- An easy-to-use plug-on adapter to the Keysight oscilloscope's AutoProbe interface
- Provides necessary probe power, calibration, and offset control as needed to the attached TekProbe probe



The N2744A T2A interface adapter enables selected TekProbe interface level 2 probes to be used with Keysight oscilloscopes with AutoProbe interface. Existing TekProbe-BNC probe types can simply be plugged into the T2A adapter, which is then plugged directly into any AutoProbe input channel on an InfiniiVision or Infiniium oscilloscope. Select the probe model in the scope menu and the Keysight oscilloscope sets up the attenuation factor and the probe type automatically. The T2A interface adapter supplies the necessary probe power, calibration (for selected models only), and offset control as used by the connected TekProbe probe. The adapter is targeted for customers using both Tek active probes with TekProbe-BNC level 2 interfaces and Keysight oscilloscopes with the AutoProbe interface.

Tek probe compatibility

The N2744A T2A adapter supports only the probes listed below with TekProbe interfaces.

AC/DC current probe	
TCP202	50-MHz AC/DC current probe
Single-ended active probes	
P6243	Single-ended active probe, 1 GHz, 10:1 without offset control
P6245	Single-ended active probe, 1.5 GHz, 10:1 with offset control
P6205	Single-ended active probe, 750 MHz, 10:1 without offset control
P6241	Single-ended active probe, 4 GHz, 10:1 with offset control
P6249	Single-ended active probe, 4 GHz, 5:1 with offset control
Differential active probes	
P5205/ P5205A	Differential probe, 100 MHz, 50:1/500:1 with offset control (works with InfiniiVision 3000X, 4000X, 6000X, 5000, 6000, and 7000 Series oscilloscopes. Choose P5205 in the listing when you use P5205A)
P5210/ P5210A	Differential probe, 50 MHz, 100:1/1000:1 with offset control (works with InfiniiVision 3000X, 4000X, 6000X, 5000, 6000, and 7000 Series oscilloscopes. Choose the P5210 in the listing when you use P5210A)
P6246	400 MHz, 10:1/1:1 with offset control
P6247	1 GHz, 10:1/1:1 with offset control
P6248	1.5 GHz, 10:1/1:1 with offset control
P6250	500 MHz, 50:1/5:1 with offset control
P6251	1 GHz, 50:1/5:1 with offset control

Keysight scope compatibility

- Keysight InfiniiVision 3000
- XT-Series with software version 1.10 or higher
- Keysight InfiniiVision 4000 X- and 6000 X-Series
- Keysight InfiniiVision 5000, 6000, and 7000 Series and future revisions (except 6000 100-MHz) with software version 06.16 or higher
- Keysight Infiniium 9000, V-Series, 90000A/X/Q, Z-Series (with N5442A) Series with software version 03.11 or higher
- Keysight Infiniium S-Series



Optical-to-electrical converters (works with InfiniiVision 5000, 6000 and 7000 with version 6.16 software only)	
P6701B	1 GHz optical-to-electrical converter with FC/PC connector
P6703B	1.2 GHz optical-to-electrical converter with FC/PC connector
P6711	250 MHz optical-to-electrical converter
P6713	300 MHz optical-to-electrical converter

Ordering information

Model number	Description
N2744A	T2A probe interface adapter

Accessories — N2784A/85A/86A/87A Probe Positioners

- Easy-to-manipulate probe arms for hands-free browsing
- One- or two-articulated arms with stable high-mass base (N2784A and N2785A)
- Quick and stable X-Y positioning (N2786A)
- Stable 3D probe positioning for hard-to-reach XYZ access
- Compatible with most scope probes
- Applications: Hands-free browsing for electronic components on PC board

The N2784A and N2785A probe positioners provide quick and stable X-Y positioning for PC boards and devices that require hands-free probing.

Unlike other probe positioners that require multiple adjustments to lock the probe holder into position, the N2784A and N2785A need only the “lift and drop” motion to put the probe in place. The weight stabilization technique used in these probe holders keeps constant pressure at the probing point so the probe tip stays in position even when the target board is bumped.

The N2786A is a low cost, easy-to-use X-Y axis probe holder for general purpose probing applications. The two-legged positioner is designed to be easy to use—, the positioner itself has no controls to position it in place.

The N2787A is a 3D probe positioner with a flexible, articulating arm that can be quickly positioned in a variety of configurations.

For more information about Keysight’s probe positioners, refer to literature number 5989-9131EN.



N2786A 2-leg probe positioner



N2787A 3D probe positioner

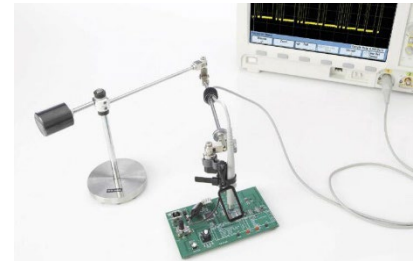

N2784A one-arm probe positioner

Ordering information

Product number	Description
N2784A ¹	1-arm probe positioner
N2785A ¹	2-arm probe positioner
N2786A	2-leg probe positioner
N2787A	3D probe positioner

1. Includes 3x magnifying glass, arm strap, cable tie, probe rest, and manual.

Accessories — Wedge Probe Adapters

- Easy connection to surface mount ICs
- Safe, with no chance of shorting
- Mechanically non-invasive contact
- 3-, 8-, and 16-signal versions
- Supports 0.5 and 0.65-mm TQFP and PQFP packages



Problem-free probing

The Keysight Wedge probe adapter eliminates many of the frustrations associated with probing surface mount components. If you have ever accidentally shorted IC pins together, experienced electrical and/or mechanical problems with soldering small wires onto leads, or gotten frustrated juggling multiple probes while you were trying to operate your scope, the Wedge was designed with you in mind.

Make the inaccessible accessible

When you use the Wedge, you do not have to worry about shorting IC pins together on a delicate component— or, on an irreplaceable prototype. The Wedge is easy to insert and it stays put. There is no need to solder small wires onto leads. The Wedge is mechanically non-invasive, so you will not damage the legs of the IC. Instead, you will have easy access to hard-to-reach components.

Operating characteristics

	E26xx Series wedge probe adapters
Operating voltage	< 40 VDC + peak AC
Operating current	0.5 A maximum
Capacitance between contacts	2 pF typical (all except Keysight-E2643A/44A) 4.33 pF typical at 1 MHz (Keysight-E2643A/44A)
Self-inductance	15 nH typical (all except Keysight E2643A/44A) 37 nH typical at 1 MHz (Keysight E2642A/44A)
Cross coupling	–31 dB typical at 100 MHz (Keysight E2643A/44A)
Contact resistance	< 0.1 Ω

Ordering information

Model number	Description	Quantity
E2613A	0.5 mm Wedge probe adapter, 3 signal	1
E2614A	0.5 mm Wedge probe adapter, 8 signal	1
E2643A	0.5 mm Wedge probe adapter, 16 signal	1
E2615A	0.65 mm Wedge probe adapter, 3 signal	1
E2616A	0.65 mm Wedge probe adapter, 8 signal	1
E2644A	0.65 mm Wedge probe adapter, 16 signal	1
10072A	SMT kit for 10070 probe family	
10075A	0.5 mm IC clip kit	

Electrical reliability

The Wedge makes two contact points with each leg of the IC. This redundant physical connection increases the electrical reliability of the connection. Also the Wedge's low capacitance and inductance provides superior performance to many other alternatives.

The Wedge probe adapter connects directly to 1145A/1155A active probes and the dual lead adapter provided with the 1160A-65A passive probe family and N2877A/N2879A accessory kits for use with N287xA Series passive probes.

IC clip kits

As an inexpensive solution for probing fine-pitch ICs, the 10072A SMT kit includes 10 IC clips and 2 dual-lead adapters that connect the clips directly to 10070-family probes.

The 10075A 0.5-mm IC clip kit is ideal for connecting to IC's as fine as 0.5 mm. The clip body allows many clips to be mounted side-by-side. The kit includes four 0.5-mm IC clips and two dual-lead adapters that connect the IC clips directly to 10070-family probes.

Accessories — Fine Pitch and PC Board Accessories

0.5 mm IC clips

- Extremely small size
- Thin body for mounting multiple clips side-by side
- Connection to PQFP and SOIC SMT packages from 0.5 to 0.8 mm (0.020 in. to 0.032 in.) lead pitch

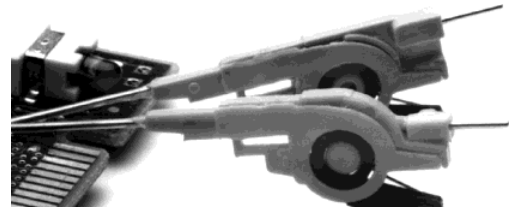

Extremely small-sized clips for probing PQFP and SOIC SMT packages.

The 0.5 mm IC clips connect directly to the Infiniium MSO logic probe flying leads, N2870A-76A or 1160A-65A passive probe with dual lead adapter, and 1007x passive probe with optional 10072A or 10075A that contain the dual lead adapter.

Maximum input voltage is +40 V.

Operating characteristics

0.5 IC Clips	
Length	31.75 mm (1.25 in)
Tip diameter	0.75 mm (0.029 in)
Pin diameter	0.75 mm (0.029 in)

Ordering information

Part number	Description	Quantity
10467-68701	0.5 mm IC clips	4

PC board mini-probe sockets (discontinued)

- Hands-free probing of through-hole devices
- Compatible with N2870A-76A and 1160A-65A family probes

The PC board mini-probe sockets are ideal for a reliable, convenient, high bandwidth connection between the N2870A-76A and 1160A-65A family passive probe tip, and the circuit under test.

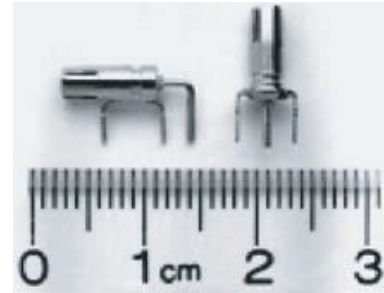

Horizontal and vertical versions of the PC board mini-probe socket make it easy to fit into your target board.

Ordering information

Part number	Description	Quantity
N2766A	Horizontal mini-probe socket	25
N2768A	Vertical mini-probe socket	25

E2697A high impedance adapter (discontinued)

- Allows connection of high impedance probes to the 50 Ω input of Infiniium 54850, 80000, and 90000 Series oscilloscopes
- Includes 500 MHz passive probe (10073D)
- Provides switchable AC/DC coupling as well as 10:1 and 1:1 attenuation settings



Ordering information

Part number	Description
N2697A	High impedance adapter

The E2697A high impedance adapter allows connection of probes that require a 1 M Ω high impedance input (e.g., passive probes, current probes) to the Infiniium 54850, 80000, and 90000 Series oscilloscopes. The E2697A high impedance adapter extends the capability of Keysight Infiniium high-performance oscilloscopes, making them ideal for a variety of general-purpose measurements such as power supplies, inverters, and semiconductor devices. The E2697A provides switchable AC/DC coupling, as well as 10:1 and 1:1 attenuation settings. Use the N5449A high impedance adapter with Infiniium V, 90000X and 90000Q Series scopes.

Related Literature

Publication title	Publication number
InfiniiVision Oscilloscope Probes and Accessories - Selection Guide	5968-8153EN
Optimizing Oscilloscope Measurement Accuracy on High-Performance Systems with Keysight Active Probes - Application Note	5988-5021EN
The Truth About the Fidelity of High-Bandwidth Voltage Probes - Application Note	5988-6515EN
Restoring Confidence in Your High-Bandwidth Probe Measurements - Application Note	5988-7951EN
Improving Usability and Performance in High-Bandwidth Active Oscilloscope Probes - Application Note	5988-8005EN
Performance Comparison of Differential and Single-Ended Active Voltage Probes - Application Note	5988-8006EN
Understanding and Using Offset in InfiniiMax Active Probes - Application Note	5988-9264EN
Time-Domain Response of InfiniiMax Probes and 54850 Series Infiniium Oscilloscopes - Application Note	5988-9608EN
Side-by-Side Comparison of Agilent and Tektronix Probing Measurements on High-Speed Signals - Application Note	5989-0553EN
Using InfiniiMax Probes with Test Equipment other than Infiniium Oscilloscopes - Configuration Guide	5989-1869EN
InfiniiMax Probes Impact on Lead-Free (ROHS) Compliance - Application Note	5989-5179EN
Oscilloscope Probes and Accessories - Selection Guide	5989-6162EN
Tips and Techniques for Making Power Supply Noise Measurements with an Scope - Application Note	5989-6755EN
Tips for Making Low Current Measurements with an Oscilloscope and Current Probe - Application Note	5989-7529EN
Extending the Range of InfiniiMax Probes - Application Note	5989-7587EN
Eight Hints for Better Scope Probing – Application Note	5989-7894EN
Oscilloscope Probing for High-Speed Signals - Application Note	5989-9177EN
Why Oscilloscope Measurements May Require Extreme Probing - Application Note	5990-4721EN
How Offset, Dynamic Range and Compression Affect Measurements - Application Note	5990-8255EN
Demystifying RCRC and RC probes - Application Note	5992-0694EN
How to select the right current probe - Application Note	5992-2656EN
Bandwidth boosting techniques for InfiniiMax probe amp and head - Application Note	5992-2975EN
Probe soldering guidelines for Keysight InfiniiMax probes - Application Note	5992-3350EN

Learn more at: www.keysight.com

For more information on Keysight Technologies' products, applications, or services, please contact your local Keysight office. The complete list is available at: www.keysight.com/find/contactus

