

# Keysight E2613/4/5/6A & E2643/4A Wedge Probe Adapters

User's Guide



## Notices

© Keysight Technologies, Inc. 1997 - 2014

No part of this manual may be reproduced in any form or by any means (including electronic storage and retrieval or translation into a foreign language) without prior agreement and written consent from Keysight Technologies, Inc. as governed by United States and international copyright laws.

## Manual Part Number

E2613-92010

Second Edition, October 2014

Printed in Malaysia

Published by:  
Keysight Technologies, Inc.  
1400 Fountaingrove Parkway  
Santa Rosa, CA, 95403

## Warranty

The material contained in this document is provided “as is,” and is subject to being changed, without notice, in future editions. Further, to the maximum extent permitted by applicable law, Keysight disclaims all warranties, either express or implied, with regard to this manual and any information contained herein, including but not limited to the implied warranties of merchantability and fitness for a particular purpose. Keysight shall not be liable for errors or for incidental or consequential damages in connection with the furnishing, use, or performance of this document or of any information contained herein. Should Keysight and the user have a separate written agreement with warranty terms covering the material in this document that conflict with these terms, the warranty terms in the separate agreement shall control.

## Technology Licenses

The hardware and/or software described in this document are furnished under a license and may be used or copied only in accordance with the terms of such license.

## Restricted Rights Legend

If software is for use in the performance of a U.S. Government prime contract or subcontract, Software is delivered and licensed as “Commercial computer software” as defined in DFAR 252.227-7014 (June 1995), or as a “commercial item” as defined in FAR 2.101(a) or as “Restricted computer software” as

defined in FAR 52.227-19 (June 1987) or any equivalent agency regulation or contract clause. Use, duplication or disclosure of Software is subject to Keysight Technologies’ standard commercial license terms, and non-DOD Departments and Agencies of the U.S. Government will receive no greater than Restricted Rights as defined in FAR 52.227-19(c)(1-2) (June 1987). U.S. Government users will receive no greater than Limited Rights as defined in FAR 52.227-14 (June 1987) or DFAR 252.227-7015 (b)(2) (November 1995), as applicable in any technical data.

## Safety Notices

### CAUTION

A **CAUTION** notice denotes a hazard. It calls attention to an operating procedure, practice, or the like that, if not correctly performed or adhered to, could result in damage to the product or loss of important data. Do not proceed beyond a **CAUTION** notice until the indicated conditions are fully understood and met.

### WARNING

A **WARNING** notice denotes a hazard. It calls attention to an operating procedure, practice, or the like that, if not correctly performed or adhered to, could result in personal injury or death. Do not proceed beyond a **WARNING** notice until the indicated conditions are fully understood and met.

# Contents

- Introduction / 5
- Electrical Characteristics / 7
- Critical Connection Information / 8
  - Differences in Supported Surface-Mounted Devices / 10
- Connecting the Adapter to an IC / 13
  - Common Ground Plane on 16-Pin Adapters / 14
- Connecting the Adapter to an Instrument / 16
  - Keysight Oscilloscopes and Logic Analyzers / 16
  - Other Instruments / 17
- Cleaning an Adapter / 18
- Repairing an Adapter / 19
  - Typical Bent Wedge Segments / 19
  - Severely Bent Wedge Segments / 20
  - Pinched Air Gap / 21



## Introduction

The wedge probe adapters can be installed on thin quad flat pack (TQFP) or plastic quad flat pack (PQFP) surface-mounted integrated circuits. This probing solution provides accurate, mechanically non-invasive contact to the TQFP/PQFP package pins. Accessories such as flexible leads enable you to connect to various oscilloscope probes and logic analyzers. When the guidelines documented in **“Critical Connection Information”** on page 8 are followed, the wedge probe adapter will provide you with many cycles of problem-free probing.

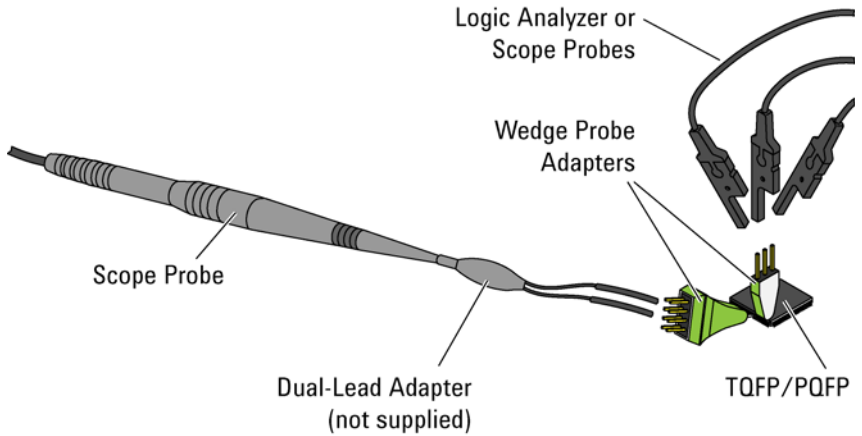







**Figure 1** Adapters Connected to TQFP/PQFP Integrated Circuits

**Table 1** shows the available adapter configurations of pin spacing and signal probing. Each model includes a user's guide and a magnifying lens. The E2643/4A 16 signal adapters include 3 removable jumpers (P/N 1258-0141 for quantity of 1 jumper). The adapters can be connected:

- Directly to 1145A and 1155A active probes.
- 1160/1/2/3/4/5A passive probes via provided dual-lead adapter.
- N2870A series passive probes via N2877A/N2879A accessory kits.

**Table 1** Available Wedge Probe Adapters

Adapter	IC Pin Spacing	Signal Count	Qty	Image
E2613A	0.5 mm	3	1	
E2614A	0.5 mm	8	1	
E2615A	0.65 mm	3	1	
E2616A	0.65 mm	8	1	
E2643A	0.50 mm	16	1	
E2644A	0.65 mm	16	1	

## Electrical Characteristics

**Table 2** Electrical Characteristics

Item	Characteristic
Operating Voltage	< 40V (dc + peak ac)
Operating Current	0.5A maximum
Capacitance Between Contacts	2 pF typical (all except E2643/4A) 4.33 pF typical at 1 MHz (E2643/4A)
Self-inductance	15 nH typical (all except E2643/4A) 37 nH typical at 1 MHz (E2643/4A)
Cross Coupling	-31 dB typical at 100 MHz (E2643/4A)
Contact Resistance	< 0.1 Ohm

## Critical Connection Information

Figure 2 shows the adapter's wedge segments properly inserted between the IC pins. Two conductors in each wedge segment make contact with the adjacent IC pins. The conductors are connected to the adapter's output pins. The adapters are designed for an IC pin spacing of either 0.5 mm or 0.65 mm. Adapters with 0.5 mm spacing are marked with orange and adapters with 0.65 mm spacing are marked with green.

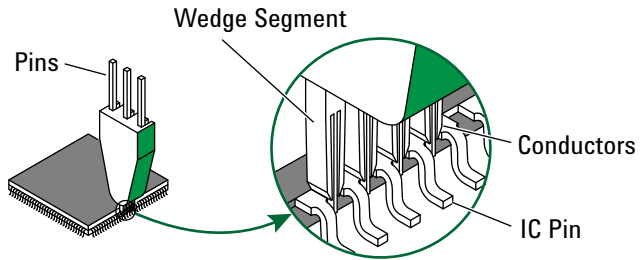

**Figure 2** Adapter Conductors Inserted Between IC Pins

Figure 3 shows that wedge segments consists of two separate conductors insulated from each other by a center insulator. A shortened insulating adhesive between the center insulator and the outer conductors creates an air gap at the tip of the wedge segment. The air gap allows the conductors to conform as the adapter is inserted between the IC pins.

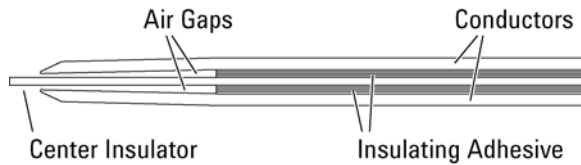
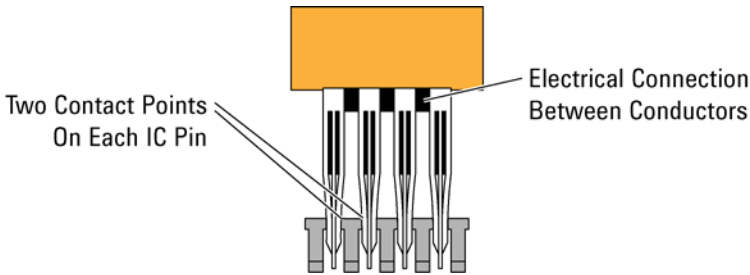

**Figure 3** Cross-Section View of Wedge Segment

The 3-signal adapter has 4 wedge segments that form 3 gaps. The 8-signal adapter has 9 wedge segments and 8 gaps. The 16-signal adapter has 17 wedge segments and 16 gaps.



The wedge segment's conductors provide two contact points on each IC pin under test as shown on [Figure 4](#). The redundant physical connection between the wedge segments and the pins on the IC package increases reliability of the electrical connection.



**Figure 4** Two Conductors on Each IC Pin

### CAUTION

The wedge probe adapter is a precision tool designed for probing at a specific IC pin gap spacing. Although to the naked eye it's difficult to see the difference between an IC having 0.5 mm or 0.65 mm pin spacing gaps. While it has been tested for 30,000 insertions, damage to the wedge probe adapter can easily occur if not used with care.

### CAUTION

Always use the magnifying glass provided to ensure the conductors of the wedge probe adapter are accurately aligned with the dam bar gaps before applying pressure to insert.

### CAUTION

Ensure that you use the correct size wedge probe adapter for the part you are probing.

### CAUTION

If damage occurs to the wedge probe adapter, refer to ["Repairing an Adapter"](#) on page 19.

### NOTE

There can be a significant variation in the pin spacing of 0.65 mm ICs. While the 0.65 mm wedge probe adapter will work with the vast majority of 0.65 mm ICs, we can not guarantee it's performance for all ICs.

## Differences in Supported Surface-Mounted Devices

The manufacturing process for making TQFP/PQFPs uses a *dam bar*, which prevents the plastic from spewing out between the pins of the part during the molding process.

After the plastic injection process is completed, the residual metal dam bar is removed to allow electrical isolation of each pin, accomplished by a precision blanking die. The resulting gap between the pins of the part is commonly referred to as the *dam bar gap*. The dam bar gap is critical for this type of probing because the wedge segments actually make electrical contact with the pins of the TQFP/PQFP package in this area.

When probing, always check the width of the dam bar gap to make sure it is free of excess solder. See [Figure 5](#) on page 11. Wicking of solder up the pin and into the dam bar region reduces the dam bar gap width, which can prevent insertion of the wedge probe adapter.

Confirm that the pin spacing gap, identified in [Figure 5](#), is 0.5 mm or 0.65 mm to ensure that the adapter will fit properly. [Figure 6](#) on page 12 show the supported surface-mounted integrated circuits and dimensions for specific ICs.

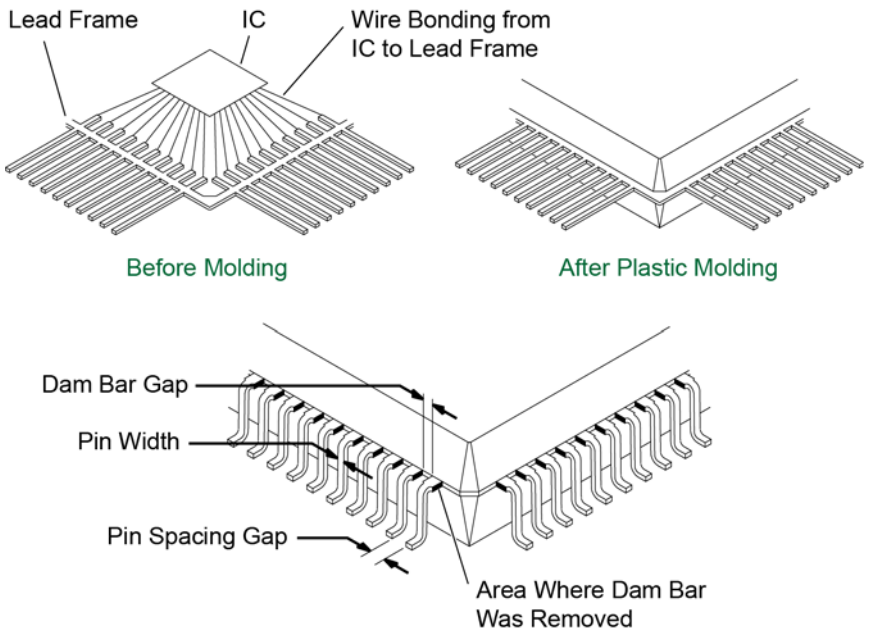

**Figure 5** Dam Bar Gaps and Pin Spacing

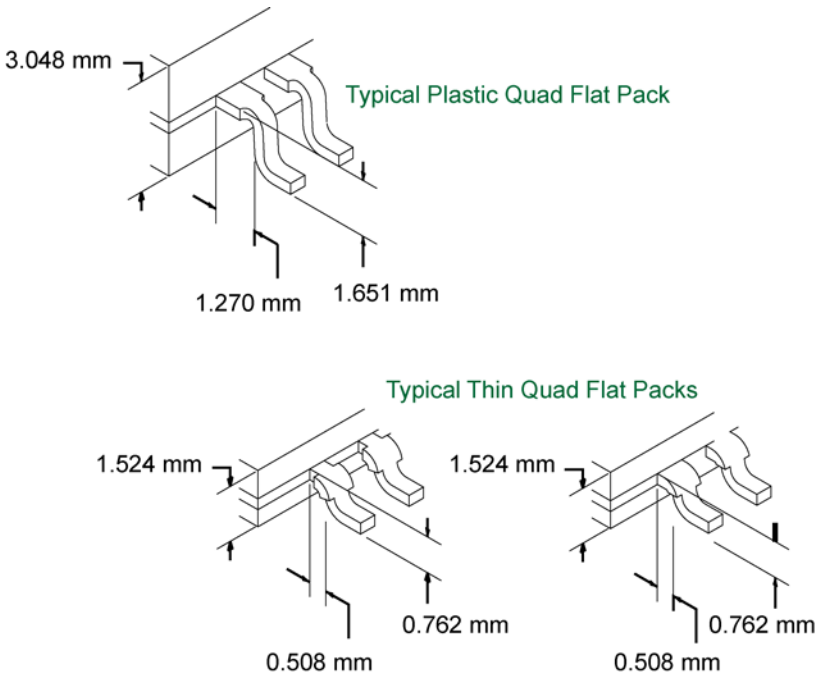

**Figure 6** Supported Surface-Mounted Integrated Circuits

## Connecting the Adapter to an IC

**CAUTION**

To avoid damaging the adapter, study “**Critical Connection Information**” on page 8 before attempting to install the adapter on an IC.

Figure 7 shows various techniques for inserting the adapter, depending on the thickness of the IC and the location of the dam bar gap. For most PQFP packages, the dam bar gap portion of the IC pin is horizontal to and adjacent to the plastic body of the package, requiring insertion of the wedge probe adapter at a 90° angle, as shown in the top portion of the figure.

For thinner packages, such as the TQFP type, the dam bar gap portion of the IC pin is often located on the bend of the pin, requiring insertion of the wedge probe adapter at a lesser angle than 90°, as shown in the bottom portion of the figure.

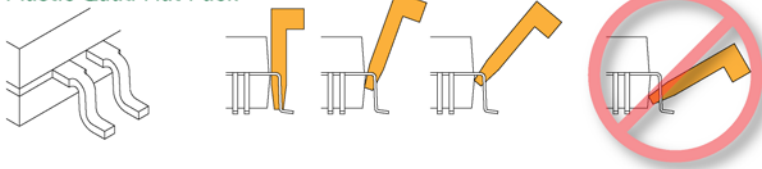
**Plastic Quad Flat Pack****Thin Quad Flat Pack**

**Figure 7** Adapter Insertion Techniques

Once the adapter is properly located between the IC pins and in the dam bar gap, apply pressure so the adapter becomes fully seated.

**CAUTION**

Ensure that the adapter is inserted at the proper angle to make contact in the dam bar gap area.

After the adapter is attached, it should have a very solid connection to the IC. You should be able to attach a lead to the adapter while maintaining a good connection to the IC. If the adapter becomes loose after you attach it, check for one of the following problems:

- the adapter has not been inserted far enough onto the pins of the IC as shown in the [Figure 7](#). Try inserting the at a different angle, perhaps an angle of less than 30° to the board.
- the adapter has not been inserted in the dam bar gap portion of the IC pins. The dam bar gap is located at the thicker part of the IC pin and is generally closer to the body of the IC. Try inserting the adapter on the portion of the IC pins closer to the body of the IC.
- the IC may be a ceramic package which has no dam bar gap. The adapters are not designed for this type of IC package.

### Common Ground Plane on 16-Pin Adapters

[Figure 8](#) on page 15 shows the pin number assignments for each probe.

The top side of the 16-pin wedge probe adapters have pins numbered 1 through 16 and provides access to IC signals. The 16 pins (marked GROUND) on the bottom side of the adapter are connected together to provide a common ground plane. If any of the signals acquired in the 16-signal segment from the IC are connected to ground, a removable jumper (3 provided) can be used to tie this IC ground signal to the ground plane connected to the bottom 16 pins on the wedge connector. After this connection is made, all 16 bottom pins are connected to ground.

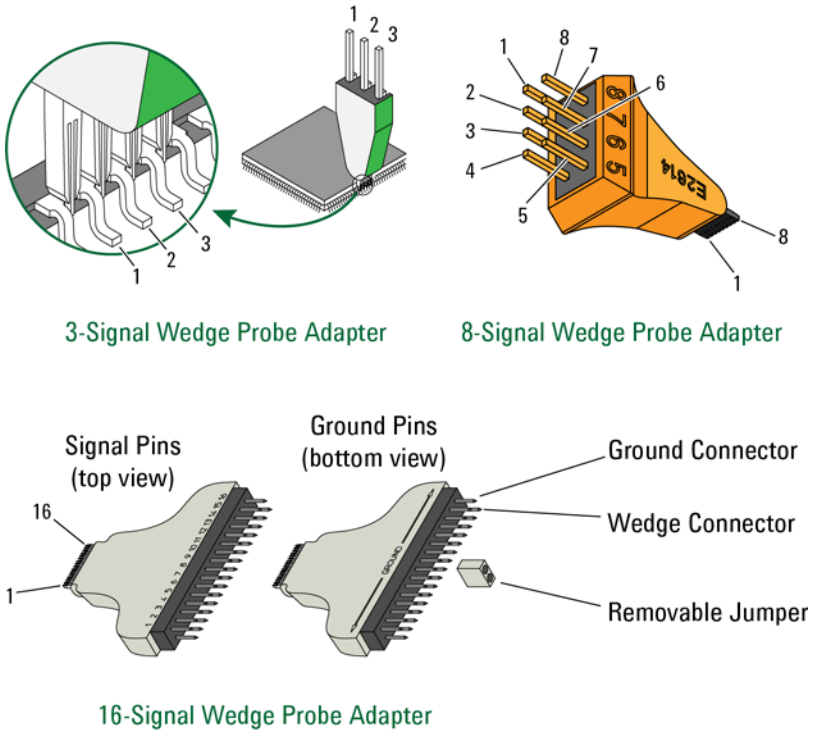
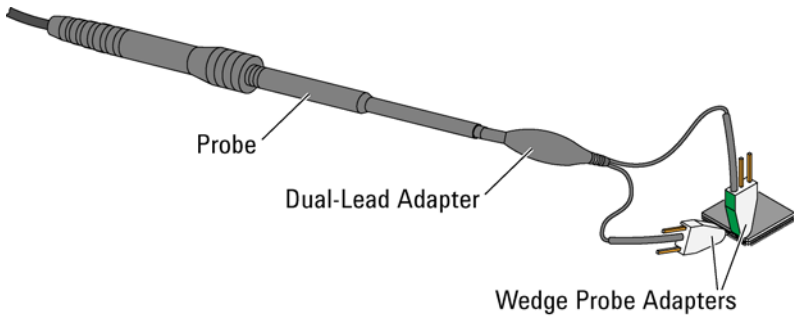

**Figure 8** Adapters Pins

## Connecting the Adapter to an Instrument



### Keysight Oscilloscopes and Logic Analyzers

The adapter can be easily attached to Keysight oscilloscopes or logic analyzers. For Keysight oscilloscope probes, use a dual lead adapter as shown below.



**Figure 9** Adapters Connected Using a Dual-Lead Adapter

**Table 3** Dual-Lead Adapters for Keysight Oscilloscope Probe Families

Keysight Probe Family	Dual lead Adapter Part Number	Image
N2870A series	0960-2898 (sold separately or with N2877A/N2879A accessory kits)	
10070 series	8710-2063	
10400A series	5081-7742	



## Other Instruments

To maintain a solid connection to the wedge probe adapter, you will need to use a flexible lead between the probe and the wedge probe adapter pins. Without the flexible lead, the weight of the probe on the wedge probe adapter will most likely cause the wedge probe adapter to disconnect from the IC.

The adapter pins are 0.635 mm square. You can build your own flexible lead as shown in Figure 10. This requires a socket designed to fit a 0.380 to 0.635 mm square pin at the end of the wire that will be connected to the wedge probe adapter. You will need to define the size of the socket at the probe end of the wire.

The probe for your instrument may include flexible leads. Also, one of the Keysight dual-lead adapters may fit your instrument's probe.

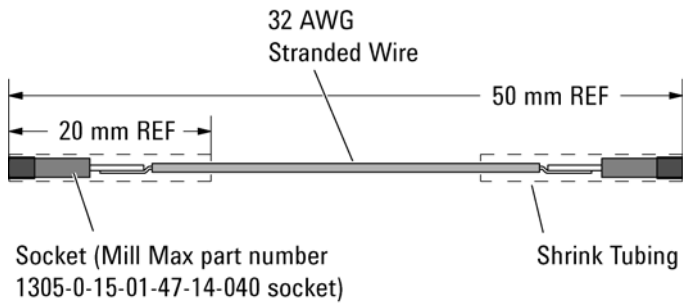
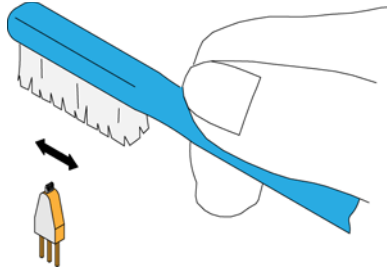

**Figure 10** Build Your Own Flexible Lead

## Cleaning an Adapter

Clean the adapter contacts before each installation. Debris on the contacts will interfere with its function.

- 1 Use a common toothbrush to remove any dust between the wedge segments. The individual wedge segments are very robust and will not be damaged by vigorous brushing.



**Figure 11** Brush in The Direction Shown

- 2 Use precision dusting cleaner (also known as inert dusting gas or compressed air in a can) to remove debris loosened by the brushing.

# Repairing an Adapter

## Typical Bent Wedge Segments

**WARNING**

To avoid possible injury, exercise care when using any sharp tool.

- 1 Use a single-edged razor blade between the wedge probe adapter conductors to straighten them as much as possible.
- 2 Repeat this on each bent wedge segment conductor.

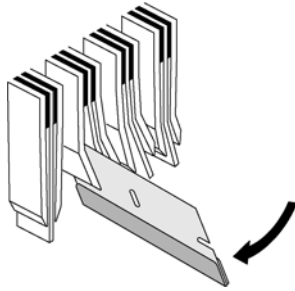

**Figure 12** Straightening Wedge Segments

- 3 Hold the Wedge Probes Adapter conductors tightly together with tweezers and flex to straighten each individual wedge segment as shown in [Figure 13](#) on page 20.

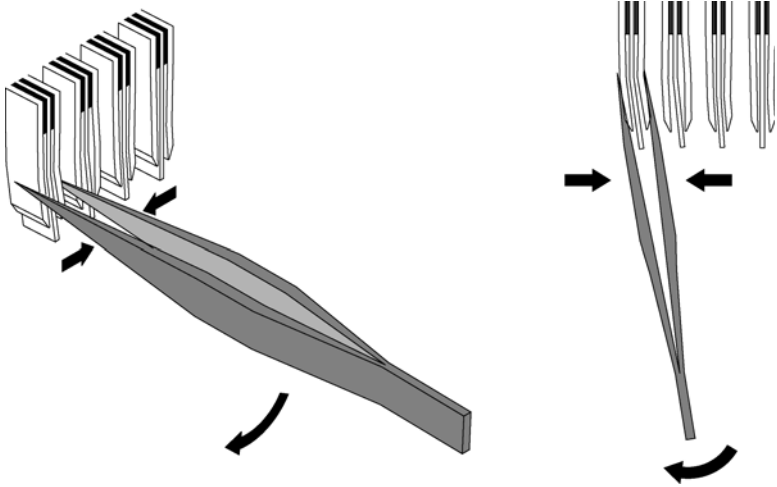

**Figure 13** Holding the Wedge Probes Adapter Conductors

#### Severely Bent Wedge Segments

- 1 Use a x20 or x40 microscope so you can see the bent wedge segment conductor.
- 2 Use a needle probe to bend the wedge segment conductor enough that you can get tweezers on it.
- 3 Gently straighten out wedge segment conductors using tweezers as shown in [Figure 14](#) on page 21.

#### NOTE

Even though the bent section often breaks due to metal fatigue, an electrical connection is often made because there are two electrical contact points on each pin of the TQFP/PQFP package. For more information on how electrical connection is made, refer to ["Critical Connection Information"](#) on page 8.

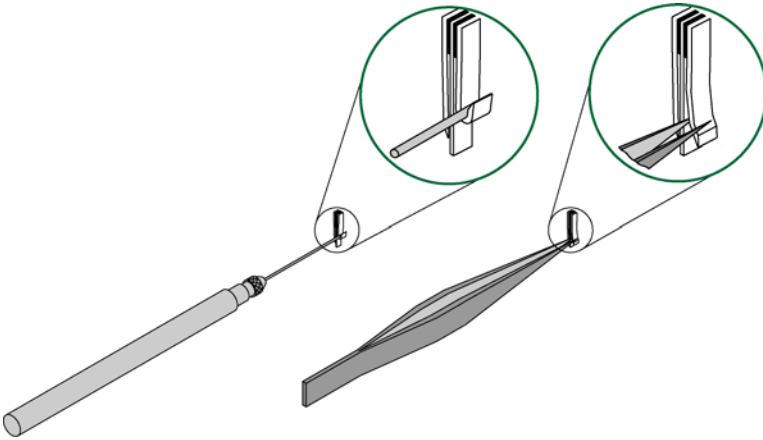

**Figure 14** Straightening Wedge Segment Conductors

#### Pinched Air Gap

The air gap is described in "[Critical Connection Information](#)" on page 8. Wedge segments may fail to make contact if this air gap is closed. The following instructions tell you how to correct this problem.

- 1 Turn the probe so that the wedge segments are facing up.
- 2 Use a x20 or x40 microscope so you can see the pinched wedge segment.

#### **WARNING**

**To avoid possible injury, exercise care when using any sharp tool.**

- 3 Insert the edge of a single-edged razor blade between the center insulator and the conductor.
- 4 Gently pry the conductor away from the center insulator to open the gap.

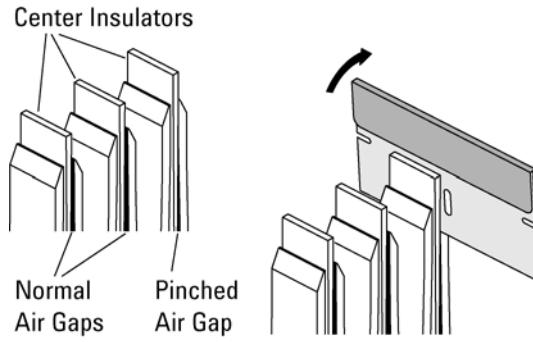

**Figure 15** Repairing a Pinched Air Gap





Keysight Technologies, Inc.  
Manual Part Number: E2613-92010