

---

# MX0023A InfiniiMax RC Probe Amplifier and Probe Heads

# Notices

© Keysight Technologies, 2020-2024

No part of this manual may be reproduced in any form or by any means (including electronic storage and retrieval or translation into a foreign language) without prior agreement and written consent from Keysight Technologies, Inc. as governed by United States and international copyright laws.

## Manual Part Number

MX0023-97000

## Edition

Fifth Edition, April 2024

Published by:  
Keysight Technologies, Inc.

1900 Garden of the Gods Road  
Colorado Springs, CO 80907 USA

## Warranty

**The material contained in this document is provided “as is,” and is subject to being changed, without notice, in future editions. Further, to the maximum extent permitted by applicable law, Keysight disclaims all warranties, either express or implied, with regard to this manual and any information contained herein, including but not limited to the implied warranties of merchantability and fitness for a particular purpose. Keysight shall not be liable for errors or for incidental or consequential damages in connection with the furnishing, use, or performance of this document or of any information contained herein. Should Keysight and the user have a separate written agreement with warranty terms covering the material in this document that conflict with these terms, the warranty terms in the separate agreement shall control.**

## Technology Licenses

The hardware and/or software described in this document are furnished under a license and may be used or copied only in accordance with the terms of such license.

## U.S. Government Rights

The Software is "commercial computer software," as defined by Federal Acquisition Regulation ("FAR") 2.101. Pursuant to FAR 12.212 and 27.405-3 and Department of Defense FAR Supplement ("DFARS") 227.7202, the U.S. government acquires commercial computer software under the same terms by which the software is customarily provided to the public. Accordingly, Keysight provides the Software to U.S. government customers under its standard commercial license, which is embodied in its End User License Agreement (EULA), a copy of which can be found at

<http://www.keysight.com/find/sweula>. The license set forth in the EULA represents the exclusive authority by which the U.S. government may use, modify, distribute, or disclose the Software. The EULA and the license set forth therein, does not require or permit, among other things, that Keysight: (1) Furnish technical information related to commercial computer software or commercial computer software documentation that is not customarily provided to the public; or (2) Relinquish to, or otherwise provide, the government rights in excess of these rights customarily provided to the public to use, modify, reproduce, release, perform, display, or disclose commercial computer software or commercial computer software documentation. No additional government requirements beyond those set forth in the EULA shall apply, except to the extent that those terms, rights, or licenses are explicitly required from all providers of commercial computer software pursuant to the FAR and the DFARS and are set forth specifically in writing elsewhere in the EULA. Keysight shall be under no obligation to update, revise or otherwise modify the Software. With respect to any technical data as defined by FAR 2.101, pursuant to FAR 12.211 and 27.404.2 and DFARS 227.7102, the U.S. government acquires no greater than Limited Rights as defined in FAR 27.401 or DFAR 227.7103-5 (c), as applicable in any

technical data. 52.227-14 (June 1987) or DFAR 252.227-7015 (b)(2) (November 1995), as applicable in any technical data.

## Safety Notices

### CAUTION

A **CAUTION** notice denotes a hazard. It calls attention to an operating procedure, practice, or the like that, if not correctly performed or adhered to, could result in damage to the product or loss of important data. Do not proceed beyond a **CAUTION** notice until the indicated conditions are fully understood and met.

### WARNING

A **WARNING** notice denotes a hazard. It calls attention to an operating procedure, practice, or the like that, if not correctly performed or adhered to, could result in personal injury or death. Do not proceed beyond a **WARNING** notice until the indicated conditions are fully understood and met.

# Contents

## 1 MX0023A Probe Amplifier - Overview

Introduction **8**

MX0023A Key Features **10**

Compatibility with Keysight Oscilloscopes **11**

## 2 Available Probe Heads and Accessories - Overview

Introduction to Supported Probe Heads **14**

When to Use Which Probe Head **16**

Other Recommended Accessories and Kits **19**

N5450B Extreme Temperature Cable Extension Kit 19

N2880A InfiniiMax In-Line Attenuator Kit 19

N2881A InfiniiMax DC Blocking Capacitors 20

MX0102A Soldering Toolkit 20

N2852A AutoProbe II to AutoProbe III Adapter 23

MX0104A Performance Verification and Deskew Fixture Kit 23

N5448B (25cm) / N2823A (1m) Coaxial Phase Matched Cable Pair 24

N2812B (1m) High Performance Input Cable 24

E2669B Differential Connectivity Kit 25

## 3 Safety and Regulatory Information

Safety Checks and Warnings **28**

Instrument Markings and Symbols **30**

## 4 Proper Handling of Probe Amplifier and Probe Heads

Avoiding Damage and Costly Repairs **32**

Using a static-safe workstation 32

Probe Amplifier and Probe Heads Handling Precautions **34**

Precautions for the Probe Amplifier 34

Precautions for the Probe Cable 34

Precautions while Connecting and Disconnecting Probe Heads **35**

Safely Connecting/Disconnecting the Probe Amplifier and Oscilloscope 35

Safely Connecting/Disconnecting the Probe Amplifier and Probe Head 35

Moving the Probing Setup to Different Probing Locations 35

Strain Relieving Techniques for Probe Heads **37**

Tack-putty 38

Low-temperature hot glue 38

Velcro Pads	39
Tips for Soldering Probe Heads	40
Cleaning	41

## 5 Characteristics and Specifications

MX0023A Probe Amplifier Warranted Specifications	44
MX0023A Probe Amplifier Characteristics	45
InfiniiMax RC Probe Heads Characteristics	47
Environmental and General Characteristics	48

## 6 MX0100A InfiniiMax Micro Probe Head

Overview	50
MX0100A Probe Head Kit Components	51
MX0100A Dimensions	51
MX0100A Input Impedance	53
Setting up and Using the MX0100A Probe Head	56
Trimming the Lead Wires of MX0100A Probe Head	56
Soldering an MX0100A Probe Head to DUT	57
Maintaining the MX0100A Probe Head	60
MX0100A Probe Head Handling Precautions	60
Replacing the MX0100A Probe Tip Lead Wires	63
Extreme Temperature Testing with the MX0100A Probe Head	66

## 7 MX0106A InfiniiMax Differential Solder-in Probe Head

Overview	68
MX0106A Probe Head Supplied Accessories	68
MX0106A Dimensions	68
MX0106A Input Impedance	70
Setting up and Using the MX0106A Probe Head	73
Adjusting the Spacing between MX0106A Wires	73
Installing / Replacing the MX0106A Probe Head Wire Leads	73
Connecting the MX0106A Probe Head to DUT	77
Soldering the MX0106A Probe Head to DUT	78
Extreme Temperature Testing with the MX0106A Probe Head	79

## 8 N2839A InfiniiMax II Browser Probe Head

Overview	82
N2839A Browser Probe Head Components	82
N2839A Supplied Accessories	82
N2839A Dimensions	84
N2839A Input Impedance	84
Using the N2839A Browser Probe Head	88

Adjusting Spacing Between the Browser Tips	88
Hands-Free Probing	88
<b>Maintaining the N2839A Probe Head</b>	<b>90</b>
N2839A Probe Head Handling Precautions	90
Location of Serial Number	90
Replacing the Browser's Tips	91
<b>9 MX0105A InfiniiMax Differential SMA Probe Head</b>	
<b>Overview</b>	<b>94</b>
MX0105A Probe Head Components	94
MX0105A Dimensions	96
MX0105A SPICE Subcircuit Data	97
MX0105A Input Return Loss (S11)	98
<b>10 N5425B InfiniiMax Differential ZIF Probe Head</b>	
<b>Overview</b>	<b>100</b>
Supported ZIF Tips	100
N5425B Probe Head and ZIF Tips Dimensions	102
<b>N5425B Input Impedance</b>	<b>104</b>
SPICE Model of N5425B Probe Head with N5426A ZIF Tip Attached	105
SPICE Deck of N5425B Probe Head with N5426A ZIF Tip Attached	106
SPICE Model of the N5426A ZIF Tip	108
SPICE Deck of N5426A ZIF Tip	109
<b>Using the N5425B Probe Head with N5426A ZIF Tips</b>	<b>111</b>
<b>Using the N5425B Probe Head with N2884A Fine Wire ZIF Tip</b>	<b>116</b>
<b>Maintaining the N5425B Probe Head</b>	<b>123</b>
Fine Wire ZIF Tips Handling Precautions	123
<b>11 Configuring Infiniium Software for Probe Amplifier and Probe Heads</b>	
<b>Selecting Components Used in the Probing Setup</b>	<b>126</b>
<b>Configuring Offset Behavior</b>	<b>129</b>
<b>Calibrating your InfiniiMax RC Probe</b>	<b>131</b>
Calibration Overview	131
Performing DC Gain / Offset and Skew Calibration	132
<b>12 Making Measurements</b>	
<b>Probing Single-ended Signals using a Differential Probe Head</b>	<b>138</b>
<b>Extreme Temperature Probing</b>	<b>139</b>
InfiniiMax RC Probe Heads Supporting Extreme Temperature Testing	139
Probe Heads Discoloration	139
Cautions Associated with Extreme Temperature Testing	140
<b>Probing Ungrounded Devices</b>	<b>141</b>

Blocking out the DC Component of the Input Signal	142
<b>13 InfiniiMax RC Probe Amplifier and Probe Heads System Responses</b>	
Typical Corrected System Frequency Response	144
Typical Step Response of Corrected System	145
Typical CMRR	146
<b>14 Performance Verification</b>	
<b>Before you Start</b>	<b>150</b>
Recommended Test Interval	150
<b>To Test Bandwidth</b>	<b>151</b>
Required Test Equipment	151
Procedure	152
<b>To Test Input Resistance</b>	<b>157</b>
Required Test Equipment	157
Procedure	157
<b>Performance Test Record</b>	<b>161</b>
<b>15 Returning a Probe/Probe Head for Repair/Service</b>	
Contacting Keysight Technologies for Technical Assistance	164
<b>16 Replacement Parts</b>	
MX0100A Probe Head	165
MX0106A Probe Head	165
N2839A Browser Head	166
Other Replacement Parts	166

Index

# 1 MX0023A Probe Amplifier - Overview

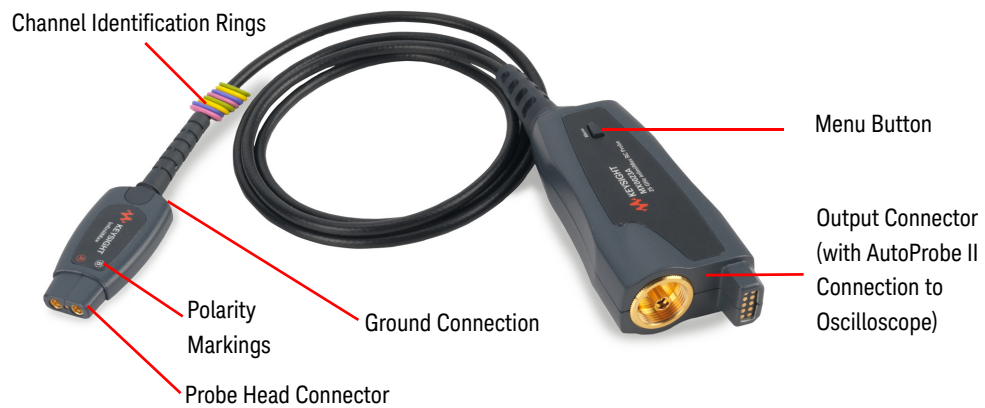
Introduction	8
MX0023A Key Features	10
Compatibility with Keysight Oscilloscopes	11

## Introduction

The MX0023A InfiniiMax RC probe amplifier provides high bandwidth of up to 25 GHz and an RC input impedance profile for extremely low mid-band loading, which is necessary to address modern high-speed probing requirements.

This probe amplifier supports a wide variety of flexible connectivity solutions, covering today's emerging signaling standards such as DDR5/LPDDR5 and other high-speed signal debug and validation test needs.

With an extensive range of supported probe heads and accessories, this probe amplifier caters to most of the probing situations including harder to probe small geometry target devices and extreme environment testing.



**Figure 1** MX0023A Probe Amplifier

**Table 1** MX0023A Probe Amplifier Components

Probe Amplifier Component	Description/Usage
Output Connector <i>(with AutoProbe II Connection to Oscilloscope)</i>	The probe amplifier uses the Keysight AutoProbe II (3.5 mm) interface that allows it to connect directly to a compatible Keysight oscilloscope (see <a href="#">page 11</a> ). The oscilloscope's AutoProbe interface provides the probe power, probe offset, and auto configuration of probe type and attenuation setting on connection.
Menu Button	Press this button to bring up the Infinii GUI's Probe Configuration dialog box on the oscilloscope. Use this dialog box to configure probe settings (see <a href="#">page 125</a> ).



**Table 1** MX0023A Probe Amplifier Components

Probe Amplifier Component	Description/Usage
Channel Identification Rings	When multiple probes are connected to the oscilloscope, use the channel identification rings to associate the channel inputs with each probe. Place one colored ring near the probe's output connector and place an identical color ring near the probe head connector.
Polarity Markings	Polarity markings to indicate the positive (+) and negative (-) inputs of the probe amplifier.
Probe Head Connector	Use this connector to connect your probe amplifier to one of the supported probe heads (see <a href="#">page 14</a> ).
Ground Connection	Allows you to connect the DUT ground to the probe amplifier ground using a ground lead wire. This is needed if the DUT is not grounded to the oscilloscope via the AC mains ground (see <a href="#">page 141</a> ).

## MX0023A Key Features

<b>Yielding Accurate Measurements</b>	The MX0023A probe amplifier has built-in probe specific s-parameter correction filter to ensure a flat frequency response. This unique s-parameter of the probe amplifier is used with the s-parameters of various supported probe heads to further flatten the magnitude and phase response of the probe for high accuracy measurements. Each probe head has different s-parameters stored in the oscilloscope's firmware. On selecting the probe head in the oscilloscope's software, the appropriate s- parameters for the probe head are used in conjunction with the probe amplifier's s-parameters to compute the overall probe correction for your measurement case.
<b>"RC" Input Impedance Architecture</b>	The probe amplifier's RC architecture makes it suitable for probing buses that transition to a "high Z" state or for probing signals with high impedance.
<b>Two Input Attenuation Ranges</b>	<p>The probe amplifier supports the following two flexible input dynamic ranges.</p> <ul style="list-style-type: none"> <li>• 600mVpp @1:1</li> <li>• 2.5Vpp @4:1</li> </ul> <p>The input range is automatically configured depending on the vertical scale of the oscilloscope.</p>
<b>AC Calibration Mode</b>	The probe amplifier supports the Vout/Vin calibration to accurately show the voltage at the tip of the probe (Vout/Vin) as loaded by the probe. Vin represents a new signal with the probe's effect included (the voltage at the probe's tip), and Vout represents the signal as passed through the probe.
<b>High Bandwidth Probing Requirements</b>	The probe amplifier efficiently fulfills the probing bandwidth requirements between 6–25 GHz. For instance, it is best suited for serial links operating up to 12 Gbps that require the probe bandwidth up to 25 GHz.
<b>Applicable System Bandwidth</b>	For any combination of a probe head with the MX0023A probe amplifier, the applicable system bandwidth is the lesser of the supported bandwidths of the probe head or the probe amplifier. The MX0023A supports 25 GHz bandwidth. Therefore, if, for example, you use it with the MX0106A probe head, which supports a 23 GHz bandwidth, then this combination would produce a system with a 23 GHz bandwidth.

## Compatibility with Keysight Oscilloscopes

Compatible Oscilloscope	Adapter Required	Required Infiniium Software Version
<b>Infiniium Oscilloscopes with AutoProbe II Interface</b>		
UXR-Series (13-33 GHz models)	none	10.25 or higher
90000 Q, V, X, Z-Series	none	6.55 or higher
<b>Infiniium Oscilloscopes with AutoProbe III Interface</b>		
UXR-Series (40 GHz or higher models)	N2852A AutoProbe II to AutoProbe III Adapter (Visit <a href="http://www.keysight.com/find/N2852A">http://www.keysight.com/find/N2852A</a> to know more about this adapter.)	10.25 or higher

### NOTE

The MX0023A probe amplifier is NOT compatible with Infiniium 9000 Series, InfiniiVision, or any previous generation Keysight oscilloscopes.

### Is your oscilloscope software up-to-date?

Keysight periodically releases software updates to support your probe, fix known defects, and incorporate product enhancements. To download the latest firmware, go to [www.Keysight.com](http://www.Keysight.com) and search for your oscilloscope's model number. Click the "Drivers, Firmware & Software" tab under the **Technical Support** link.

## 1 MX0023A Probe Amplifier - Overview

## 2 Available Probe Heads and Accessories – Overview

Introduction to Supported Probe Heads	14
When to Use Which Probe Head	16
Other Recommended Accessories and Kits	19
N5450B Extreme Temperature Cable Extension Kit	19
N2880A InfiniiMax In-Line Attenuator Kit	19
N2881A InfiniiMax DC Blocking Capacitors	20
MX0102A Soldering Toolkit	20
N2852A AutoProbe II to AutoProbe III Adapter	23
MX0104A Performance Verification and Deskew Fixture Kit	23
N5448B (25cm) / N2823A (1m) Coaxial Phase Matched Cable Pair	24
N2812B (1m) High Performance Input Cable	24
E2669B Differential Connectivity Kit	25

This chapter provides an overview of various probe heads and accessories that are compatible for use with the MX0023A probe amplifier.

## Introduction to Supported Probe Heads

A probe amplifier connects to a DUT via a probe head.

When using the MX0023A probe amplifier, you can choose from a wide variety of probe heads and accessories to support your specific probing and DUT connectivity requirements.

The probe heads supported for MX0023A are primarily categorized as follows:

Probe Head	Where to Find Detailed Information
New InfiniiMax RC Probe Heads (supporting higher bandwidths up to 25 GHz)	Detailed information on each of these probe heads is available as separate chapters in this guide.
Existing InfiniiMax I and II Probe Heads (supporting bandwidths up to 12 GHz)	Most of the existing InfiniiMax I and II probe heads are compatible for use with the MX0023A probe amplifier (see <a href="#">Figure 2</a> on page 15). Detailed information on each of these probe heads is available in the <i>Keysight 1168/9B-Series Differential and Single-Ended Probes</i> user's guide. This guide is available for download from the Document Library tab on <a href="http://www.keysight.com/find/1169B">www.keysight.com/find/1169B</a> .

### NOTE

InfiniiMax III and III+ probe heads are NOT compatible for use with the MX0023A probe amplifier.

The following figure displays these supported probe heads and accessories for MX0023A.

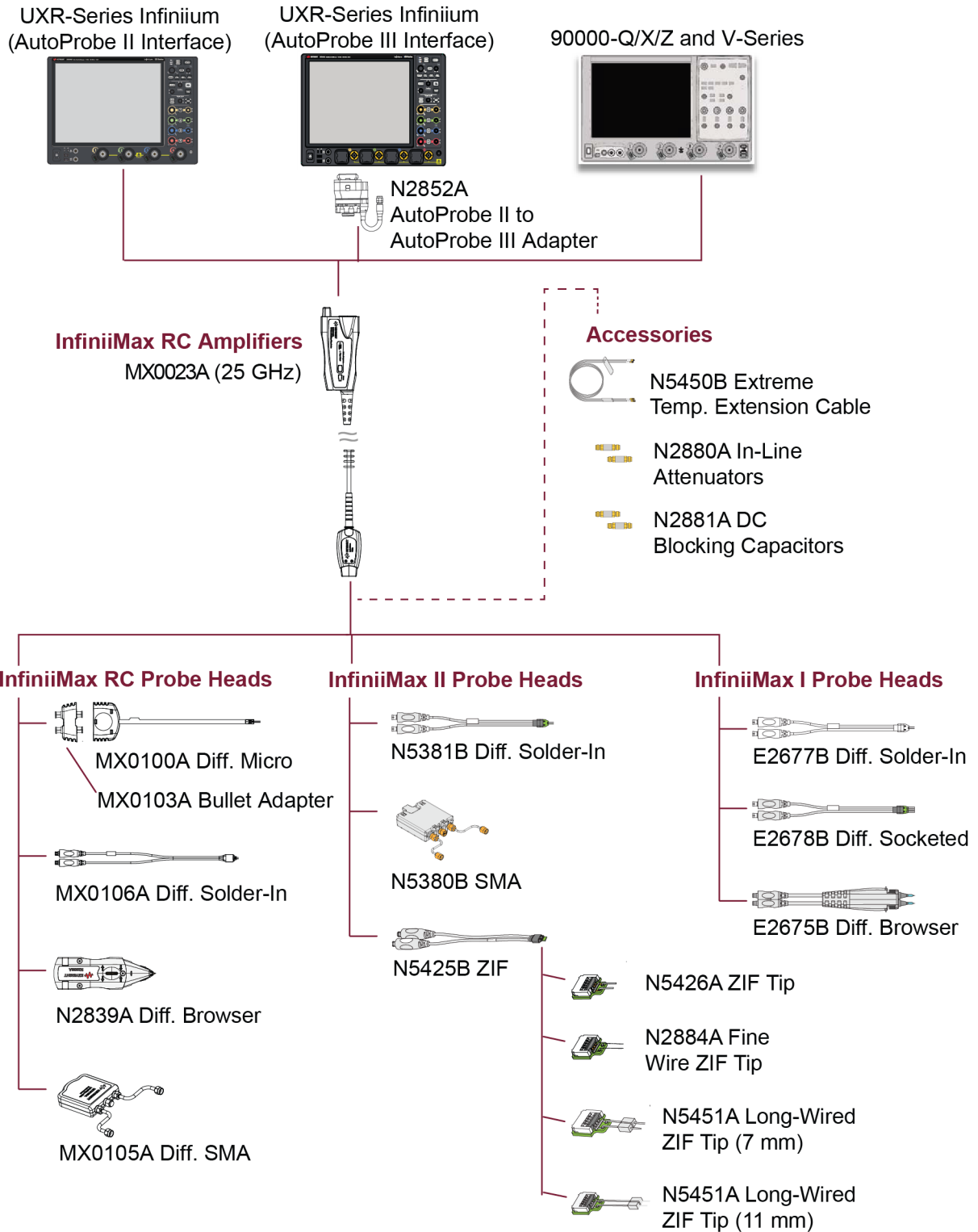






Figure 2 MX0023A Probe Family Diagram

## When to Use Which Probe Head

The following table provides a high-level comparison of the supported probe heads to help you assess when to use which probe head with MX0023A.




These probe heads are listed in the order of their maximum supported bandwidth when used with the MX0023A probe amplifier.

**Table 2** Supported Probe Heads (Sheet 1 of 3)





Probe Head (listed in the order of BW)	Recommended Usage	Bandwidth <sup>a</sup>	C <sub>diff</sub> <sup>b</sup> (pF)	C <sub>se</sub> <sup>c</sup> (pF)
<b>1. MX0100A InfiniiMax Micro Probe Head</b> (refer to <a href="#">page 49</a> for details)				
	<ul style="list-style-type: none"> <li>Light, flexible, and smallest solder-in head</li> <li>Best suited for providing uncompromised access to small geometry, high-density fine-pitch targets</li> <li>Recommended for high-speed signaling standards DDR4, DDR5, LPDDR4, LPDDR5, MIPI D-Phy 2.0/3.0, C-Phy, and M-Phy</li> </ul>	25 GHz	0.17 pF	0.26 pF
<b>2. MX0106A Differential Solder-in Probe Head</b> (refer to <a href="#">page 67</a> for details)				
	<ul style="list-style-type: none"> <li>The most reliable semi-permanent signal access for high fidelity measurement</li> <li>Hands-free access to fine-pitch components in high-density electronics</li> <li>Recommended for MIPI D-Phy 2.0 and C-Phy 2.0</li> </ul>	23 GHz	0.17 pF	0.29 pF
<b>3. N2839A InfiniiMax II Browser Probe Head</b> (refer to <a href="#">page 81</a> for details)				
	<ul style="list-style-type: none"> <li>Hand-held browsing for general purpose troubleshooting of a circuit board</li> <li>Adjustable probe tips for different circuit geometries</li> </ul>	21 GHz	0.20 pF	0.34 pF
<b>4. MX0105A Differential SMA Probe Head</b> (refer to <a href="#">page 93</a> for details)				
	<ul style="list-style-type: none"> <li>Suitable for differential cabled measurement using only one channel of the oscilloscope</li> <li>Offset matched SMA cables adapt to variable spacing</li> <li>Ideal for signaling standards such as HDMI and MIPI Mphy that require termination to a common DC voltage (<math>\pm 4</math> V) rather than a ground</li> </ul>	21 GHz	N/A	N/A



**Table 2** Supported Probe Heads (Sheet 2 of 3)

Probe Head (listed in the order of BW)	Recommended Usage	Bandwidth <sup>a</sup>	C <sub>diff</sub> <sup>b</sup> (pF)	C <sub>se</sub> <sup>c</sup> (pF)
<b>5. N5425B Differential ZIF Probe Head</b> (refer to <a href="#">page 99</a> for details)				
	<ul style="list-style-type: none"> <li>▪ Ideal for probing multiple signals in tight spaces such as DDR memory</li> <li>▪ ZIFs can be installed at multiple locations on your DUT</li> <li>▪ Ideal for hard to reach, small fine pitch targets</li> <li>▪ ZIF feature allows connection without compressing the delicate wires which cannot support this compression</li> <li>▪ Recommended for DDR4, DDR5, LPDDR4, MIPI D-Phy 2.0 and C-Phy 2.0</li> </ul>	<b>With N5426A ZIF Tip</b>		
		18 GHz	0.33 pF	0.53 pF
		<b>N2884A Fine Wire ZIF Tip</b>		
		18 GHz	0.35 pF	N/A
<b>6. N5381B Differential Solder-in Probe Head</b> (refer to 1168/9B-Series Probes user's guide)				
	<ul style="list-style-type: none"> <li>▪ Solder-in hands free connection</li> <li>▪ Recommended for DDR4, DDR5, LPDDR4, MIPI D-Phy 2.0</li> </ul>	12 GHz	0.21 pF	0.35 pF
<b>7. N5380B Differential SMA Probe Head</b> (refer to 1168/9B-Series Probes user's guide)				
	<ul style="list-style-type: none"> <li>▪ Suitable for differential cabled measurement using only one channel of the oscilloscope</li> <li>▪ Offset matched SMA cables adapt to variable spacing</li> <li>▪ Ideal for signaling standards such as HDMI and MIPI Mphy that require termination to a common DC voltage (<math>\pm 4</math> V) rather than a ground</li> </ul>	12 GHz	N/A	N/A
	<p><b>Note:</b> The plastic housing on the N5380B needs to be removed to mate with the MX0023A amplifier. Refer to the 1168/9B-Series Probes user's guide for details of this removal procedure.</p>			

**Table 2** Supported Probe Heads (Sheet 3 of 3)

Probe Head (listed in the order of BW)	Recommended Usage	Bandwidth <sup>a</sup>	Cdiff <sup>b</sup> (pF)	Cse <sup>c</sup> (pF)
<b>8. N5425B ZIF Probe Head with Long Wire ZIF Tips</b> (refer to 1168/9B-Series Probes user's guide)				
	<ul style="list-style-type: none"> <li>The long-wired ZIF tips connection is ideal for variable pitch targets, including larger pitches</li> <li>Ideal for probing multiple signals in tight spaces such as DDR memory</li> <li>ZIFs can be installed at multiple locations on your DUT</li> <li>ZIF feature allows connection without compressing the delicate wires which cannot support this compression</li> <li>Recommended for DDR4, DDR5, LPDDR4, MIPI D-Phy 2.0 and C-Phy 2.0</li> </ul>	<b>With 7mm N5451A ZIF Tip</b>		
		~9.9 GHz (0° tip span)	0.6 pF	0.58 pF
		<b>With 11mm N5451A ZIF Tip</b>		
		~4.4 GHz (60° tip span)		
		~5 GHz (0° tip span)	0.68 pF	0.68 pF
		~3.3 GHz (60° tip span)		
<b>9. E2677B Differential Solder-in Probe Head</b> (refer to 1168/9B-Series Probes user's guide)				
	<ul style="list-style-type: none"> <li>Hands-free solder-in connection</li> </ul>	12 GHz	0.27 pF	0.44 pF
<b>10. E2678B Differential Socketed Probe Head</b> (refer to 1168/9B-Series Probes user's guide)				
	<ul style="list-style-type: none"> <li>Measuring signal via a plug-on socket connection</li> <li>Removable connection using solder-in resistor pins for hard to reach targets</li> </ul>	12 GHz	0.34 pF	0.56 pF
<b>11. E2675B Differential Browser Probe Head</b> (refer to 1168/9B-Series Probes user's guide)				
	<ul style="list-style-type: none"> <li>Hand-held browsing for general purpose troubleshooting of a circuit board</li> </ul>	6 GHz	0.32 pF	0.57 pF

<sup>a</sup> The bandwidth listed in this table is the maximum bandwidth supported by each probe head. For any combination of a probe head with a probe amplifier, the applicable bandwidth is the lesser of the supported bandwidths of the probe head or the probe amplifier. For example, using the MX0023A, which supports a 25 GHz bandwidth, with a MX0106A, which supports a 23 GHz bandwidth, would produce a system with a 23 GHz bandwidth.

<sup>b</sup> Capacitance seen by differential signals

<sup>c</sup> Capacitance seen by single-ended signals

## Other Recommended Accessories and Kits

In addition to the probe heads listed in the previous section, there are a number of kits and accessories available for use with the MX0023A probe amplifier.

This section provides an overview to these recommended accessories and kits. You can either order these at the time of ordering the probe amplifier or separately later.

### N5450B Extreme Temperature Cable Extension Kit

The N5450B extreme temperature cable extension kit allows you to use the MX0023A probe amplifier to probe a device in an environment chamber.

The MX0023A probe amplifier has an operating temperature range from 5° C to 40° C and cannot be subjected to extreme temperatures. But a few probe heads can be operated over a much larger range of temperatures. The N5450B extension cables allow you to physically separate the amplifier from the probe head so that the probe head can be operated inside a temperature chamber while the probe amplifier remains outside the chamber.



Refer to the topic **“Extreme Temperature Probing”** on page 139 to know more.

**Table 3** N5450B Kit Contents

Item	Qty Supplied	Description
Phase-matched RF Cables	2	To ensure a high-quality measurement, the N5450B cable set have been phase-matched at the factory.
Coupling Tag	1	A coupling tag is included with the cables to ensure that the cables stay as a matched pair.

### N2880A InfiniiMax In-Line Attenuator Kit

The N2880A In-Line Attenuators allow you to increase the maximum input range and offset range of the MX0023A probe amplifier so that you can measure signals larger than the probe’s maximum input range and offset range.



**Figure 3** Attenuators Between a Probe Amplifier and a Probe Head

**Table 4** N2880A Kit Contents

Item	Qty Supplied	Description
6 dB Attenuators	2	These attenuators come as matched pairs and should only be used with each other. Each attenuator has a serial number.
12 dB Attenuators	2	The pair of matching attenuators in each set will have the same four digit numeric prefix and will differ by the last letter
20 dB Attenuators	2	(one attenuator in the matched pair will be labeled A and the other will be labeled B).

### N2881A InfiniiMax DC Blocking Capacitors

The N2881A InfiniiMax DC Blocking Capacitors block out the DC component of the input signal (up to 30 Vdc). You can place these between the MX0023A probe amplifier and probe head as shown in the picture below.



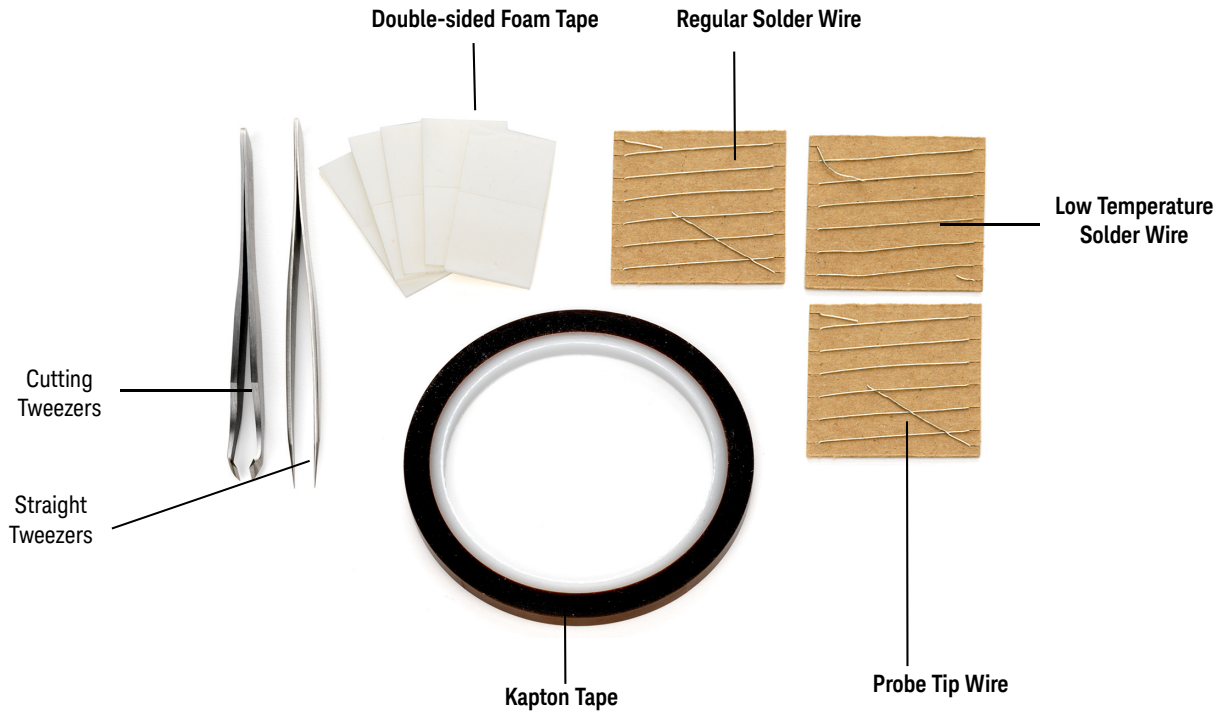
**Figure 4** Placement of DC Blocking Capacitor Between a Probe Amplifier and a Probe Head

You can also use these DC blocking capacitors with the N2880A In-Line Attenuators. The order of the two products in the probing system (that is, which one is closer to the probe amplifier) does not matter.

Refer to the topic **“Blocking out the DC Component of the Input Signal”** on page 142 to know more.

### MX0102A Soldering Toolkit

The MX0102A soldering toolkit provides tools that can make soldering tasks easier. For instance, you can use the tools available in this kit while soldering the lead wires of the MX0100A Micro probe head to a DUT (see **page 57** for details).



**Figure 5** MX0102A soldering toolkit contents

**Table 5** Accessories supplied in the soldering toolkit

Description	Qty Supplied	Part Number <sup>a</sup>
<b>Straight Tweezers</b> (Anti-magnetic straight pointed tip 120mm) For general purpose manipulation / movement of components such as probe tip wires and probe head.	1	8710-2837
<b>Cutting Tweezers</b> (Narrow oblique head 115mm) To cut a probe tip wire to a desired length.	1	8710-2838
<b>Kapton Tape (36 yards roll)</b> To provide strain-relief to the neck portion of the probe head by taping it to a flat surface (such as a DUT circuit board).	1	0460-3121
<b>Double-sided Foam Tape</b> To provide strain-relief to either the neck portion of the probe head or the plastic housings by taping it to a flat surface such as a tabletop or a DUT circuit board.	10	0460-3122
<b>Regular Solder Wire</b> Lead free, .009" diameter, 2 feet long To attach the probe tip wires to a DUT using standard lead-free soldering temperatures (330 °C to 350 °C). (NOTE: This alloy melts at 217 °C.)	1	MX0102-21302
<b>Low Temperature Solder Wire</b> Lead free, .010" diameter, 2 feet long To attach the probe tip wires to a DUT using a low temperature setting on your soldering iron. (NOTE: This alloy melts at 138 °C.)	1	MX0102-21303
<b>Probe Tip Wire</b> .004" diameter, 2 feet long To add ground wires to your probe tip if InfiniiMode measurements (differential, single ended, and common mode signals with a single probe tip) are desired. Clip as short as possible using the cutting tweezers included in the kit.	1	MX0102-21301

<sup>a</sup> You can reorder these items using the part numbers included in the table above.

## N2852A AutoProbe II to AutoProbe III Adapter

This adapter allows you to connect the MX0023A probe amplifier that has the AutoProbe II interface to the Keysight UXR-Series (40 GHz or higher) Infiniium oscilloscope that has the AutoProbe III interface.

To know more about the N2852A adapter, visit <http://www.keysight.com/find/N2852A> and then download the adapter's user's guide available in the **Document Library** tab.



### CAUTION

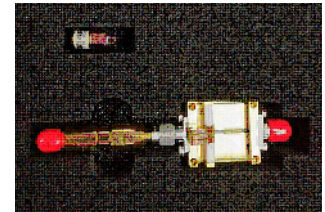
Care should be taken while handling the N2852A adapter's RF cable. Avoid bending this cable backwards or kinking the cable to ensure measurements accuracy.

## MX0104A Performance Verification and Deskew Fixture Kit

The MX0104A PV/Deskew fixture helps you to calibrate / deskew or verify the performance of your MX0023A probe amplifier.



**Table 6** MX0104A Kit Contents

Item	Qty Supplied
50Ω SMA Terminator	1
Deskew Fixture	1



The MX0104A fixture is used with the following two components to promote the proper positioning of the probe during the deskew/PV procedure.

**Table 7** MX0104A Optional Components

Option	Usage
N2787A 3D Probe Positioner 	For more sophisticated probe head positioning Highly recommended for MX0023A probe amplifier. Also, highly recommended when using probe heads such as the browser probe head to hold the browser in place.
Option 001: Performance Verification Stand 	For convenient, handy, and low-cost probe head positioning Recommended for use with InfiniiMax III/III+ probe amplifiers and heads only

- To know how to use this fixture for deskew/calibration of your probe, refer to the chapter **“Performing DC Gain / Offset and Skew Calibration”** on page 132.
- To know how to use this fixture for performance verification of your probe, refer to the chapter **“Performance Verification”** on page 149.

### N5448B (25cm) / N2823A (1m) Coaxial Phase Matched Cable Pair

The N5448B (25cm) / N2823A (1m) phase matched cable pair allows you to extend the cable length of the MX0105A SMA probe head and add flexibility and convenience to the probing setup. You can easily replace the supplied rigid cables of the SMA probe head with these cables. These cables support 2.92 mm male-to-2.92 mm male connection. Skew error between two cables are matched to within 5 psec, and the cable supports up to 40 GHz.

For detailed specifications of these cables, refer to the user’s guide available in the **Document Library** tab of [www.keysight.com/find/N5448B](http://www.keysight.com/find/N5448B).



**Figure 6** N2823A and N5448B Coaxial Phased Matched Cable Pairs

**CAUTION**

The maximum bend radius for these coaxial cable pairs is 30 mm. Bending these cables at too tight a radius or twisting the cables can cause damage, reduce performance, and impact the precision of these cables.

### N2812B (1m) High Performance Input Cable

The N2812B input cable provides excellent flexibility, high quality measurements, and a warranted bandwidth of 32 GHz. You can use this cable with the Infiniium V, 90000-X/Q, UXR <=33 GHz series oscilloscopes.





## E2669B Differential Connectivity Kit

The E2669B differential connectivity kit provides multiple quantities of the:

- following three InfiniiMax I probe heads supported for use with the MX0023A probe amplifier.
- accessories needed for these three probe heads.

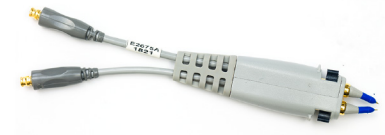
E2678B Differential Socketed  
(quantity 2)



E2677B Differential Solder-In  
(quantity 4)



E2675B Differential Browser  
(quantity 1)



**Figure 7** E2669B Differential Connectivity Kit (*not to scale*)

**Table 8** E2669B Kit Contents

Probe Heads Included in the Kit	Qty Supplied
E2678B Differential Socketed Head	2
E2677B Differential Solder-In Head	4
E2675B Differential Browser	1

Other Accessories Included in the Kit	Qty Supplied	Used With			Part Number (Not orderable)
		E2678B	E2677B	E2675B	
160 $\Omega$ damped wire accessory	12	?			01130-21303
82 $\Omega$ resistor for full bandwidth	96	?			01130-81506
Socket for 25 mil (25/1000 inch) square pins, female on both ends	8	?			01131-85201
25 mil female socket w/20 mil round male pin on other end	8	?			01131-85202
Heat shrink socket accessory	8	?			01130-41101
Header adapter, 91 $\Omega$	4	?			01130-63201
82 $\Omega$ resistor template	1	?			01131-94309
91 $\Omega$ resistor for full bandwidth	80		?		1NC3-1091
150 $\Omega$ resistor for medium bandwidth	40		?		1NC3-1150
91 $\Omega$ resistor template	1		?		01131-94311
150 $\Omega$ resistor template	1		?		01131-94308
Resistive tip (blue), 91 $\Omega$	20			?	01131-62107
Ergonomic handle	1			?	01131-43201

**NOTE**

Resistor performance. The S2 resistors were changed from 100 $\Omega$  to 91 $\Omega$  for slightly better performance. Either value produces a response that is well within specifications. If you have some of the older 100 $\Omega$  resistors, ensure that you use either two 100 $\Omega$  or two 91 $\Omega$  resistors. Do not mix them.

## 3 Safety and Regulatory Information

Safety Checks and Warnings	28
Instrument Markings and Symbols	30

## Safety Checks and Warnings



This manual provides information and warnings essential for operating this probe and probe heads in a safe manner and for maintaining these in safe operating condition. To ensure safe operation and to obtain maximum performance from the probe, carefully read and observe the following warnings, cautions, and notes.

These products have been designed and tested in accordance with accepted industry standards, and have been supplied in a safe condition. The documentation contains information and warnings that must be followed by the user to ensure safe operation and to maintain these products in a safe condition.

Note the external markings on the products that are described in this document.

To avoid personal injury and to prevent fire or damage to these products or products connected to these, review and comply with the following safety precautions.

### WARNING



**Use Only Grounded Instruments. Do not connect the probe's ground lead to a potential other than earth ground. Always make sure the probe and oscilloscope are grounded properly. Before making connections to the input leads of this probe, ensure that the probe's output connector is attached to the channel input of the oscilloscope and the oscilloscope is properly grounded.**

---

### WARNING

**Connect and Disconnect Properly.**  
See [page 35](#) for the sequence in which connection/disconnection needs to be done.

---

### WARNING

**Observe Probe Voltage Ratings.**  
Do not apply any electrical potential to the probe input which exceeds the maximum rating of the probe. See [page 45](#) for maximum input voltage ratings. These probe assemblies are NOT intended for measurements on mains circuits (CAT II, CAT III, and CAT IV).

---

### WARNING

**Indoor Use Only.**  
Do not operate in wet/damp environments. Keep product surfaces dry and clean.

---

### WARNING

**Never leave the probe connected to a conductor while it is not connected to an oscilloscope or voltage measuring instrument.**

---

### WARNING

**Periodically inspect the probe and probe wires to check for any damage. Do Not Operate With Visible or Suspected Failures. If you suspect there is damage, have it inspected by a Keysight authorized service personnel.**

---

**WARNING**

Do not operate the probe or oscilloscope in the presence of flammable gasses or fumes. Operation of any electrical instrument in such an environment constitutes a definite safety hazard.

---

**WARNING**

If the probe/probe heads are used in a manner not specified by the manufacturer, the protection provided by these may be impaired.

---

**WARNING**

Do not install substitute parts or perform any unauthorized modification to the probe amplifier / probe head.

Do not attempt internal service or adjustment. Service should be carried out by a Keysight Technologies authorized service personnel. For any service needs, contact Keysight Technologies. See [page 163](#) to know more.

---

**CAUTION**

The probe cable is a sensitive part of the probe and, therefore, you should be careful not to damage it through excessive bending or pulling. Avoid any mechanical shocks to this product in order to guarantee accurate performance and protection.

---

Concerning the Oscilloscope or Voltage Measuring Instrument to Which the Probe is Connected

**WARNING**

Whenever it is likely that the ground protection is impaired, you must make the instrument inoperative and secure it against any unintended operation.

---

**WARNING**

If you energize the instrument by an auto transformer (for voltage reduction or mains isolation), the ground pin of the input connector terminal must be connected to the earth terminal of the power source.

---

**WARNING**

Before turning on the instrument, you must connect the protective earth terminal of the instrument to the protective conductor of the (mains) power cord. The mains plug shall only be inserted in a socket outlet provided with a protective earth contact. You must not negate the protective action by using an extension cord (power cable) without a protective conductor (grounding). Grounding one conductor of a two-conductor outlet is not sufficient protection.






---

**WARNING**

Capacitors inside the instrument may retain a charge even if the instrument is disconnected from its source of supply.

---

## Instrument Markings and Symbols

Symbol	Description
	<p>This symbol indicates the Environmental Protection Use Period (EPUP) for the product's toxic substances for the China RoHS requirements.</p>
	<p>Notice for the European Community: This product complies with the WEEE Directive (2002/96/EC) marking requirements. The affixed label indicates that you must not discard this electrical/electronic product in domestic household waste.</p> <p>Product Category: With reference to the requirement types in the WEEE Directive Annex I, this product is classed as a "Monitoring and Control Instrumentation" product.</p> <p>Do not dispose in domestic household waste.</p> <p>To return unwanted products, contact your local Keysight office.</p>
	<p>This symbol indicates that it is necessary for you to follow the instructions in the user's guide to protect against damage to the product or personal injury.</p>
	<p>Contains parts or assemblies susceptible to damage by electrostatic discharge (ESD). Use electrostatic discharge protective handling procedures. See <a href="#">page 32</a> to know more.</p>
	<p>Earth (ground) TERMINAL. Refer to the instructions accompanying this symbol in this guide.</p>

## 4 Proper Handling of Probe Amplifier and Probe Heads

Avoiding Damage and Costly Repairs	32
Using a static-safe workstation	32
Probe Amplifier and Probe Heads Handling Precautions	34
Precautions while Connecting and Disconnecting Probe Heads	35
Strain Relieving Techniques for Probe Heads	37
Tips for Soldering Probe Heads	40
Cleaning	41

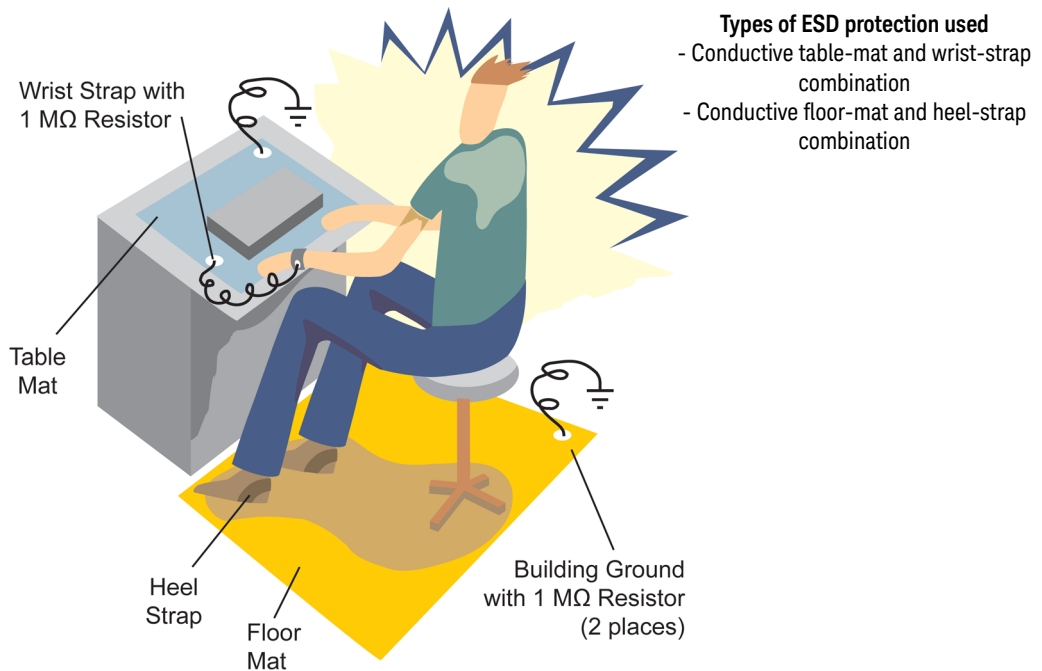
This chapter provides cautions, warnings, and tips to properly handle your probe/probe heads to prevent damage and maintain accurate and high performance.

## Avoiding Damage and Costly Repairs

### Using a static-safe workstation



InfiniiMax RC probes and accessories are ESD sensitive devices. Before using or handling any of these, always wear a grounded ESD wrist strap and ensure that cables and probe heads are discharged before being connected. All work, including connecting probe amplifiers to the oscilloscope, should be performed at a static-safe work station as shown in the following figure.

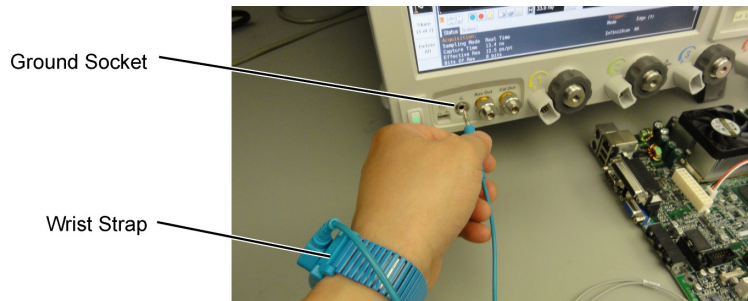


**Figure 8** Static-Safe Workstation

Both types of ESD protection illustrated in the above figure, when used together, provide a significant level of ESD protection. When used alone, only the table-mat and wrist-strap combination provides adequate ESD protection. To ensure user safety, the static-safe accessories must provide at least 1 MW of isolation from ground. Purchase acceptable ESD accessories from your local supplier.

You can plug the ESD wrist strap into the front-panel ground socket of the oscilloscope as seen in the following picture.





**Figure 9** Wrist Strap Connected to Oscilloscope's Ground Socket

**WARNING**

These techniques for a static-safe workstation should not be used when working on circuitry with a voltage potential greater than 500 volts.

---

## Probe Amplifier and Probe Heads Handling Precautions

### Precautions for the Probe Amplifier

The probe amplifier has been designed to withstand a moderate amount of physical and electrical stress. Store the probe and its probe heads in a shock-resistant case such as the foam-lined shipping case which came with the probe.

**CAUTION**

Do not apply excessive force to the probe end and prevent it from receiving mechanical shock. This damage is considered to be abuse and will void the warranty when verified by Keysight Technologies service professionals.

---

**CAUTION**

Do not drop heavy objects on the probe, drop the probe from large heights, spill liquids on the probe, etc. Any of these examples can significantly degrade the performance of the probe.

---

### Precautions for the Probe Cable

**CAUTION**

Do not twist, tightly bend, or kink the probe amplifier cable to avoid degrading the probe's performance.

---

**CAUTION**

When storing the probe, it is best to coil the cable in a large radius and avoid a net twist in the cable during the process. This can be done in a similar manner to how garden hoses or extension cords are typically coiled.

---

## Precautions while Connecting and Disconnecting Probe Heads

### Safely Connecting/Disconnecting the Probe Amplifier and Oscilloscope

Always perform the connection in the following sequence:

- 1 Ground the DUT to the oscilloscope via the AC mains ground or to the oscilloscope ground or to the probe amplifier ground.
- 2 Connect the probe head to the DUT.
- 3 Connect the probe amplifier to the grounded oscilloscope.
- 4 Connect the probe head to the probe amplifier.

#### CAUTION

Never allow the probe head to be connected to the probe amplifier, if the probe amplifier is *not* connected to an oscilloscope channel.

---

Always perform the disconnection in the following sequence:

- 1 Disconnect the probe head from the probe amplifier.
- 2 Disconnect the probe amplifier from the oscilloscope.
- 3 Disconnect / unsolder the probe head from the DUT.

This sequence is also applicable when moving the probe amplifier from one oscilloscope channel to another.

### Safely Connecting/Disconnecting the Probe Amplifier and Probe Head

When connecting a probe head to a probe amplifier, push the probe head connectors straight in the amplifier's sockets. When disconnecting a probe head from an amplifier, pull the probe head connectors straight out of the sockets.

#### CAUTION

Never bend the probe head in order to pry it loose from the amplifier. Also, do not wiggle the probe head up and down or twist it to remove the connectors from the sockets. This can damage the pins in the amplifier or probe head.

---

### Moving the Probing Setup to Different Probing Locations

When making measurements, you may often need to probe different locations on the DUT.

- For the MX0105A SMA head or the N2839A browser probe head, you can safely move the probe head from one location to another without having to first break the amplifier-to-head connection.

#### 4 Proper Handling of Probe Amplifier and Probe Heads

- For a solder-in or a ZIF tip probe head, always disconnect the probe head from the amplifier *before* unsoldering, moving to a new position, and resoldering the probe head. This is because some soldering-iron tips can hold a charge which can damage the probe amplifier.

## Strain Relieving Techniques for Probe Heads

High-performance probes have small physical geometries to ensure the lowest possible loading and the best electrical response. Because of their small size, probe heads are often delicate. It is important to mechanically secure your probe heads to protect both your equipment and designs from damage.

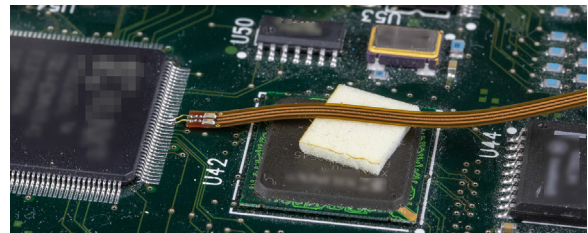
The following are some of the strain relief methods that you can use for your probe amplifier/probe head. Different probe heads can have different cable stiffness. Choose a strain relief method appropriate for the cable stiffness.

- Tack Putty (recommended)
- Low-temperature hot glue (recommended)
- Non-conductive double-sided tape
- Hook-and-loop

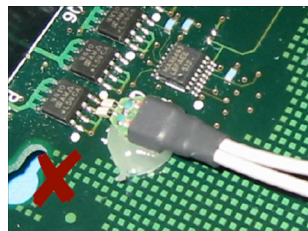
### CAUTION

Do not use aggressive adhesives, super glues, or high temperatures.

Do not get the low temperature hot glue on the probe head tip as this can damage the precision components of your probing system (only use the low temperature hot glue on the probe head cables).



Correct securing methods

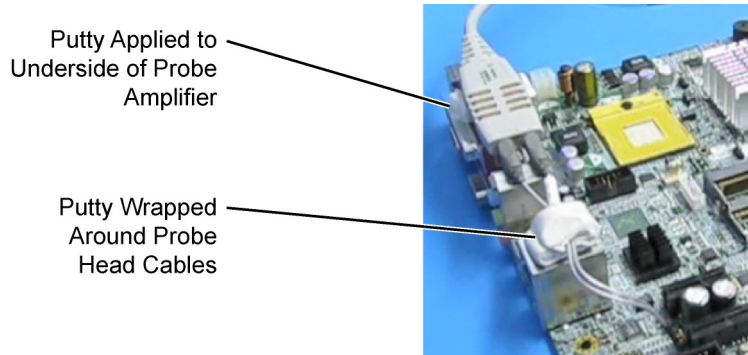


Incorrect securing method with glue on the probe head tip

**Figure 10** Correct and incorrect strain relief techniques

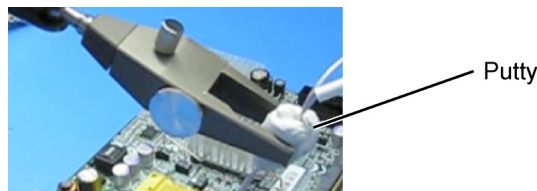
## Tack-putty

Wrap a small amount of tack-putty around your probe head cables, taking care to not pinch them. The mass can then be secured to a rigid body near your DUT. Similar techniques can be used to secure probe amplifiers where you apply some tack-putty to the underside of the probe amplifier body and attach it to a rigid body near your DUT.



**Figure 11** Probe Secured Using Tack Putty

You can also use putty with a positioner such as the N2787A as shown below.



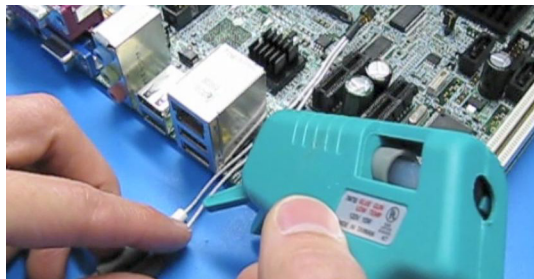
**Figure 12** Using Putty With the N2787A 3D Probe Positioner

## Low-temperature hot glue

You can also use low-temperature hot glue to secure cables.

**CAUTION**

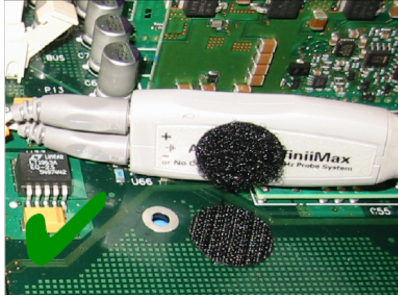
Only use *low-temperature* hot glue. To remove the hot glue, warm it with a heat gun set on low. Only heat the hot glue enough to remove it.



**Figure 13** Probe Secured Using Low-Temperature Hot Glue

## Velcro Pads

The provided Velcro pads can be used to secure your probe amplifier casing to the board. Attach Velcro dots to the probe amplifier as well as the circuit board as shown in the figure below.



**Figure 14** Using Velcro Dots

## Tips for Soldering Probe Heads

Given below are a few soldering tips that apply to all probe heads that require soldering to DUT. The specific details related to the soldering procedure for each probe head are included in the chapter dedicated to that probe head in this guide.

- Use a temperature-controlled soldering iron station, if possible.
- Set the temperature of the soldering iron's tip to between 370° C and 420° C (for non RoHS standards).
- Use the smallest tip possible.
- Use an optical aid of some sort (microscope preferred).
- Employ minimal dwell times on the solder joint (< 2 seconds).
- Solder only the tip of the wire onto your DUT. The solder should not get close to the existing solder ball on the tip.
- Apply enough flux to probe head leads and wires when soldering the tips into a DUT.

### See Also

- [Soldering Guidelines for Keysight InfiniiMax Probes Application Note](#) (publication number 5992-3350EN)
- ["Soldering an MX0100A Probe Head to DUT"](#) on page 57
- ["Step 3 - Solder the N5426A ZIF Tip to the DUT"](#) on page 112



## Cleaning

If the probe amplifier or probe head requires cleaning:

- 1** Disconnect the probe head from the probe amplifier.
- 2** Disconnect the probe amplifier from the oscilloscope.
- 3** Disconnect the probe head from any circuit under test.
- 4** Gently clean the probe amplifier /probe head with a soft cloth dampened with a mild soap and water solution.
- 5** Wipe with clean water and then dry thoroughly with a clean cloth.
- 6** Make sure that the probe amplifier / probe head is completely dry before reconnecting it to an oscilloscope or circuit under test.

## 4 Proper Handling of Probe Amplifier and Probe Heads

## 5 Characteristics and Specifications

MX0023A Probe Amplifier Warranted Specifications 44

MX0023A Probe Amplifier Characteristics 45

InfiniiMax RC Probe Heads Characteristics 47

Environmental and General Characteristics 48

The tables in this chapter list the specifications and characteristics for the MX0023A probe amplifier and its supported probe heads.

### NOTE

All entries included in this chapter are characteristics unless otherwise noted. These are the typical performance values of the MX0023A probe amplifier with different probe heads.

Bandwidth (for the probe) and DC Input Resistance ( $R_{se}$  and  $R_{diff}$ ) are the only warranted specifications for the MX0023A probe amplifier.

---

## MX0023A Probe Amplifier Warranted Specifications

**Table 9** Warranted Specifications

Probe Amplifier	Probe Head	Specification	
MX0023A 25 GHz Probe Amplifier	MX0100A Micro Probe Head	Bandwidth	25 GHz (with 60 mil leads)
		DC Input Resistance	$R_{diff} = 50 \text{ k}\Omega \pm 2\%$ $R_{se} = 25 \text{ k}\Omega \pm 2\%$

## MX0023A Probe Amplifier Characteristics

The characteristics listed in the following table are mainly determined by the probe amplifier.

Characteristic	MX0023A Probe Amplifier	
	With 25k $\Omega$ Probe Heads (MX0100A, MX0106A, N2839A, MX0105A, N5425B, N5381B)	With MX0105A SMA Probe Head
DC Input Resistance	$R_{se} = 25 \text{ k}\Omega \pm 2\%$ each input to ground $R_{diff} = 50 \text{ k}\Omega \pm 2\%$	50 $\Omega$ to $V_{term}$
Maximum Input Power	NA	100 mW or $2.28V_{rms}$ ( $V_{in}-V_{cm\_term}$ ) into 50 $\Omega$
Input Voltage Range (Differential or Single Ended)	0.6 Vpp, $\pm 0.3 \text{ V}$ at 1:1 attenuation 2.5 Vpp, $\pm 1.25 \text{ V}$ at 4:1 attenuation	0.38 Vpp, $\pm 0.19 \text{ V}$ at 1:1.57 attenuation 1.54 Vpp, $\pm 0.77 \text{ V}$ at 2.57:1 attenuation
Input Common Mode Range	$\pm 8 \text{ V}_{DC}$ to 100 Hz $\pm 0.5 \text{ V}$ > 100 Hz at 1:1 attenuation, $\pm 4 \text{ V}$	$\pm (4.3 \text{ V} - V_{cm\_term} \times 0.29)$ (DC to 100 Hz), $\pm 0.19 \text{ V}$ at 1:1.57 attenuation, $\pm 0.77 \text{ V}$ at 2.57:1 attenuation (> 100 Hz)
Maximum Signal Slew Rate	25 V/ns when probing a single-ended signal 40 V/ns when probing a differential signal	16 V/ns when probing a single-ended signal 26 V/ns when probing a differential signal
DC Attenuation Ratio	1:1 or 4:1 Automatically selected based on volts/division setting	1:1.56 or 2.57:1 Automatically selected based on volts/division setting
Offset Range (for probing a single-ended signal)	$\pm 16 \text{ V}$	
Offset Accuracy	< 3%	
Zero offset error referred to input	< 2 mV x DC attenuation	< 2 mV
Input referred noise, in spectral density	25.0 nV/ $\sqrt{\text{Hz}}$ @1:1 39.7 nV/ $\sqrt{\text{Hz}}$ @4:1	16 nV/ $\sqrt{\text{Hz}}$ @1:1.56 25.5 nV/ $\sqrt{\text{Hz}}$ @2.57:1
Input referred noise, in mVrms	3.95 mVrms @1:1 & 25 GHz 6.28 mVrms @4:1 & 25 GHz	2.26 mVrms @1:1.56 & 21 GHz 3.61 mVrms @ 2.57:1 & 21 GHz
Propagation delay <sup>a</sup>		~6.1 nsec

Characteristic	MX0023A Probe Amplifier	
	With 25k $\Omega$ Probe Heads (MX0100A, MX0106A, N2839A, MX0105A, N5425B, N5381B)	With MX0105A SMA Probe Head
Maximum Non-destructive Input Voltage	30 V <sub>peak</sub> mains isolated <sup>b</sup>	See maximum input power

a Delay can be skewed relative to other signals.

b Mains isolated is for measurements performed on circuits not directly connected to a mains supply.

## InfiniiMax RC Probe Heads Characteristics

The characteristics listed in **Table 10** are mainly determined by the InfiniiMax RC probe heads available for the MX0023A probe amplifier.

**Table 10** Characteristics for InfiniiMax RC Probe Heads Using MX0023A Probe Amplifier

Probe Head	Input Capacitance		Bandwidth (-3 dB)	10 - 90% Transition Time	20 - 80% Transition Time
	Cdiff	Cse			
MX0100A Micro probe head (with 60 mil leads)	170 fF	260 fF	25 GHz	17.4 pS	12.3 pS
MX0100A Micro probe head (with 135 mil leads)	170 fF	260 fF	12 GHz	36.3 pS	25.7 pS
MX0106A Differential Solder-in Probe Head	170 fF	290 fF	23 GHz	18.9 pS	13.4 pS
N2839A InfiniiMax II Browser Probe Head	205 fF	340 fF	21 GHz	20.7 pS	14.7 pS
MX0105A Differential SMA Probe Head		NA	21 GHz	21.8 pS	15.4 pS
N5425B Differential ZIF Probe Head (With N5426A ZIF Tip)	330 fF	530 fF	18 GHz	24.1 pS	17.1 pS

### NOTE

For information on the characteristics and specifications for the following InfiniiMax I and II probe heads that are compatible for use with the MX0023A probe amplifier, refer to the *Keysight 1168/9B-Series Differential and Single-Ended Probes user's guide*. Visit [www.keysight.com/find/1169B](http://www.keysight.com/find/1169B) to download this guide.

- N5381B Differential Solder-in Probe Head
- N5380B Differential SMA Probe Head
- N5425B ZIF Probe Head with N5451A Long Wire ZIF Tips
- E2677B Differential Solder-in Probe Head
- E2678B Differential Socketed Probe Head
- E2675B Differential Browser Probe Head

## Environmental and General Characteristics

**Table 11** Environmental and General Characteristics of MX0023A amplifier and InfiniiMax RC Probe Heads

Environmental Condition	Operating	Non-Operating
Temperature	+5 °C to +40 °C	-40 °C to +70 °C
Humidity	Up to 95% relative humidity (non-condensing) at +40 °C	Up to 90% relative humidity at +65 °C
Altitude	Up to 4,600 meters	Up to 15,300 meters
Dimensions	Refer to the <i>Dimensions</i> section in the chapter dedicated to each probe head in this guide.	
Weight	211 g (probe only) 790 g (probe with case and contents) 1.34 kg (probe with packaging)	
Pollution Degree	Pollution Degree 2 Normally only non-conductive pollution occurs. Occasionally, however, a temporary conductivity caused by condensation must be expected.	

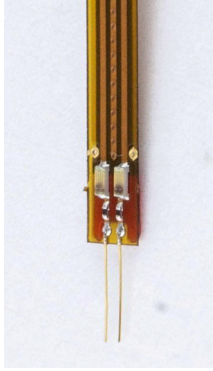


## 6 MX0100A InfiniiMax Micro Probe Head



Overview	50
MX0100A Probe Head Kit Components	51
MX0100A Dimensions	51
MX0100A Input Impedance	53
Setting up and Using the MX0100A Probe Head	56
Trimming the Lead Wires of MX0100A Probe Head	56
Soldering an MX0100A Probe Head to DUT	57
Maintaining the MX0100A Probe Head	60
MX0100A Probe Head Handling Precautions	60
Replacing the MX0100A Probe Tip Lead Wires	63
Extreme Temperature Testing with the MX0100A Probe Head	66

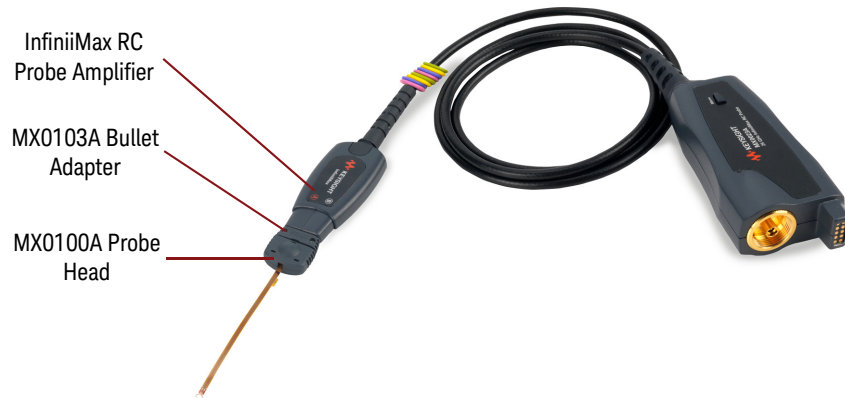
## Overview



The MX0100A is a solder-in head designed to access small geometry target devices. The probe head is made out of flex printed circuit, making it light, flexible, small yet highly usable. It provides up to 25 GHz of full probe amplifier bandwidth when used with the MX0023A and excellent probe loading characteristic (170 fF). You can replace and trim the probe head's gold plated nickel tip lead.

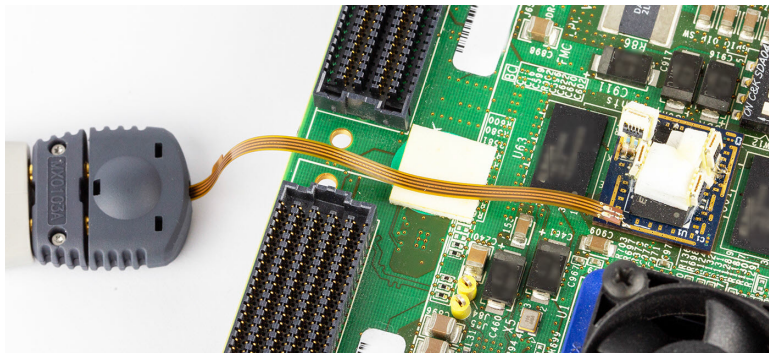
The probe head offers wide operating temperature range of -55 °C to +150 °C (per JEDEC JESD22-A104 revision E spec), making it ideal for environmental chamber testing with the probe head soldered to the DUT inside the chamber.

This probe head connects easily to the InfiniiMax RC probe amplifier using the bullet adapter shipped with the probe head.



**Figure 15** MX0100A probe head connected to InfiniiMax RC probe amplifier

For connection to a DUT, it has pre-wired probe tip leads that allow solder-in connection to very small, fine pitch targets.



**Figure 16** MX0100A probe head connected to DUT and InfiniiMax probe amplifier

See [page 43](#) for characteristics and specifications of MX0100A probe head and MX0023A probe amplifier.

**NOTE**

When probing differential signals, the + and – connection of the MX0100A probe head can be determined when the probe head is plugged into the probe amplifier. The + and - indicators on the probe amplifier represent the + and - inputs on MX0100A probe head. When probing single-ended signals, ensure that the - input of the probe amplifier is connected to the ground of the DUT.

## MX0100A Probe Head Kit Components

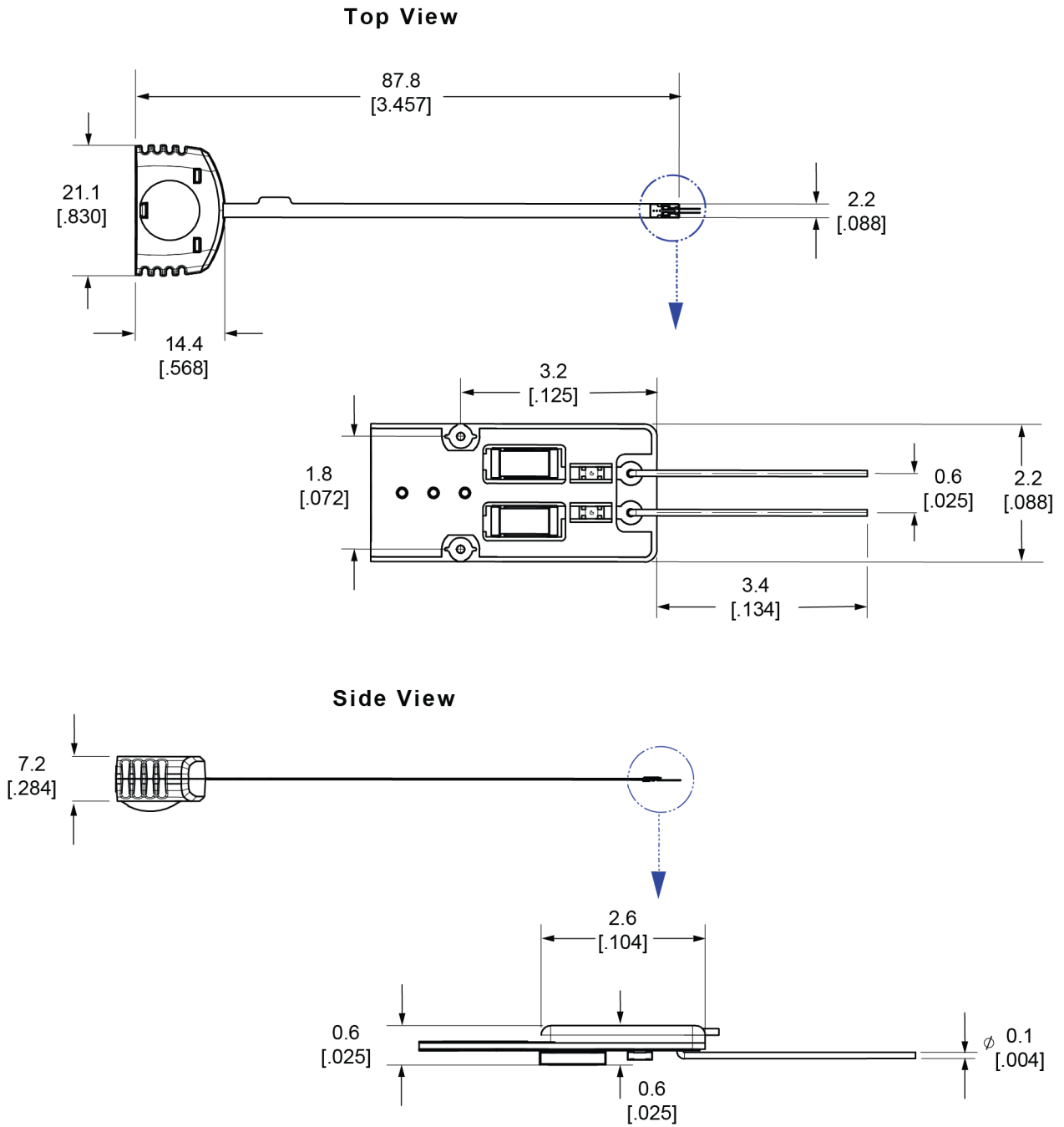
**Table 12** MX0100A Probe Head Kit Components

Component	Quantity *			Part Number
	Option 001	Option 002	Option 003	
Micro Probe Heads (with pre-wired probe tips)	5	25	50	MX0100A
Probe Tip Wire (.004" diameter) (To make ground connections)	1 wire spool	5 wire spools	10 wire spools	MX0102-21301
Bullet Adapter	1	5	10	MX0103A
Trim Gauge Template (see <a href="#">Figure 20</a> )	1	5	10	MX0100-94302

\* Quantity varies based on the purchased option.

## MX0100A Dimensions

All dimensions in [Figure 17](#) are in mm [inches].



**Figure 17** MX0100A Probe Head Dimensions

## MX0100A Input Impedance

**NOTE**

Input impedance is a function of the probe head only. The probe amplifier bandwidth (25 GHz) does not have any effect on the input impedance of the probe head.

---

This section provides:

- the SPICE model for MX0100A. This SPICE model is only for input impedance which allows modeling of the probe loading effects. Probe transfer function is generally flat to the specified bandwidth.
- an input impedance plot for MX0100A to show the matching of the measured data to the modeled data. Matching is generally very good up to the specified bandwidth of the probe head.

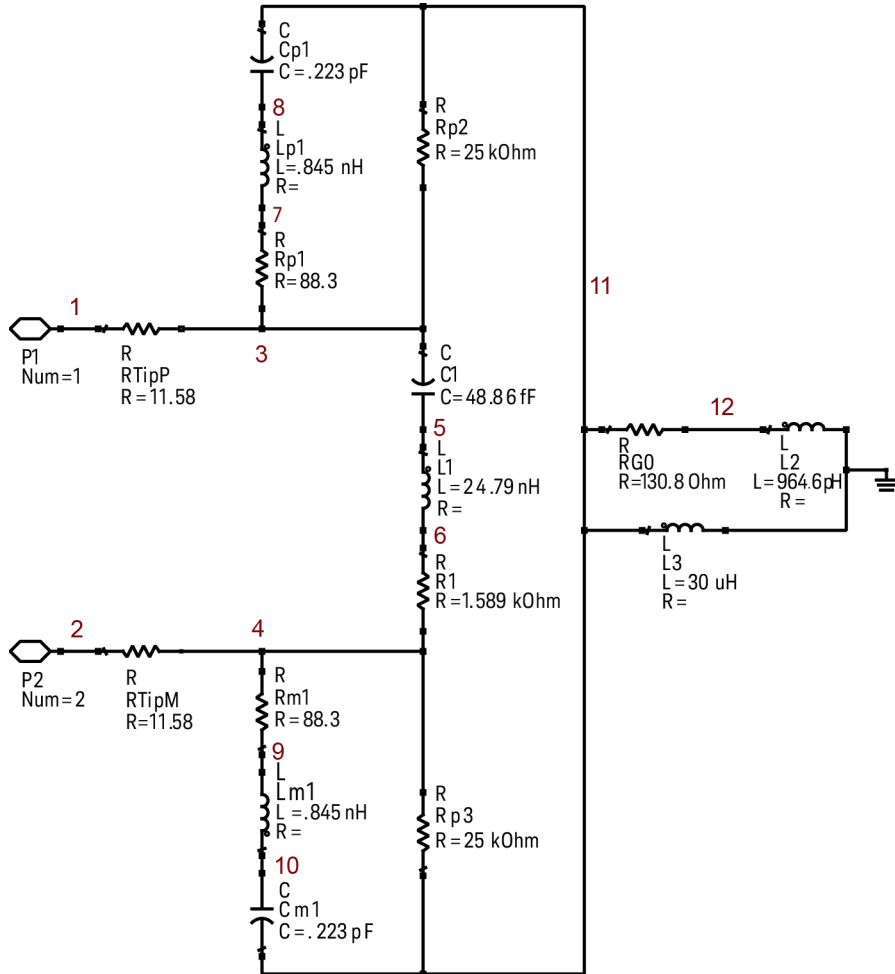
**NOTE**

Refer to the chapter **"InfiniiMax RC Probe Amplifier and Probe Heads System Responses"** on page 143 to get a typical corrected frequency response and CMRR for the MX0100A probe head and MX0023A probe amplifier combination.

---

### MX0100A SPICE Model

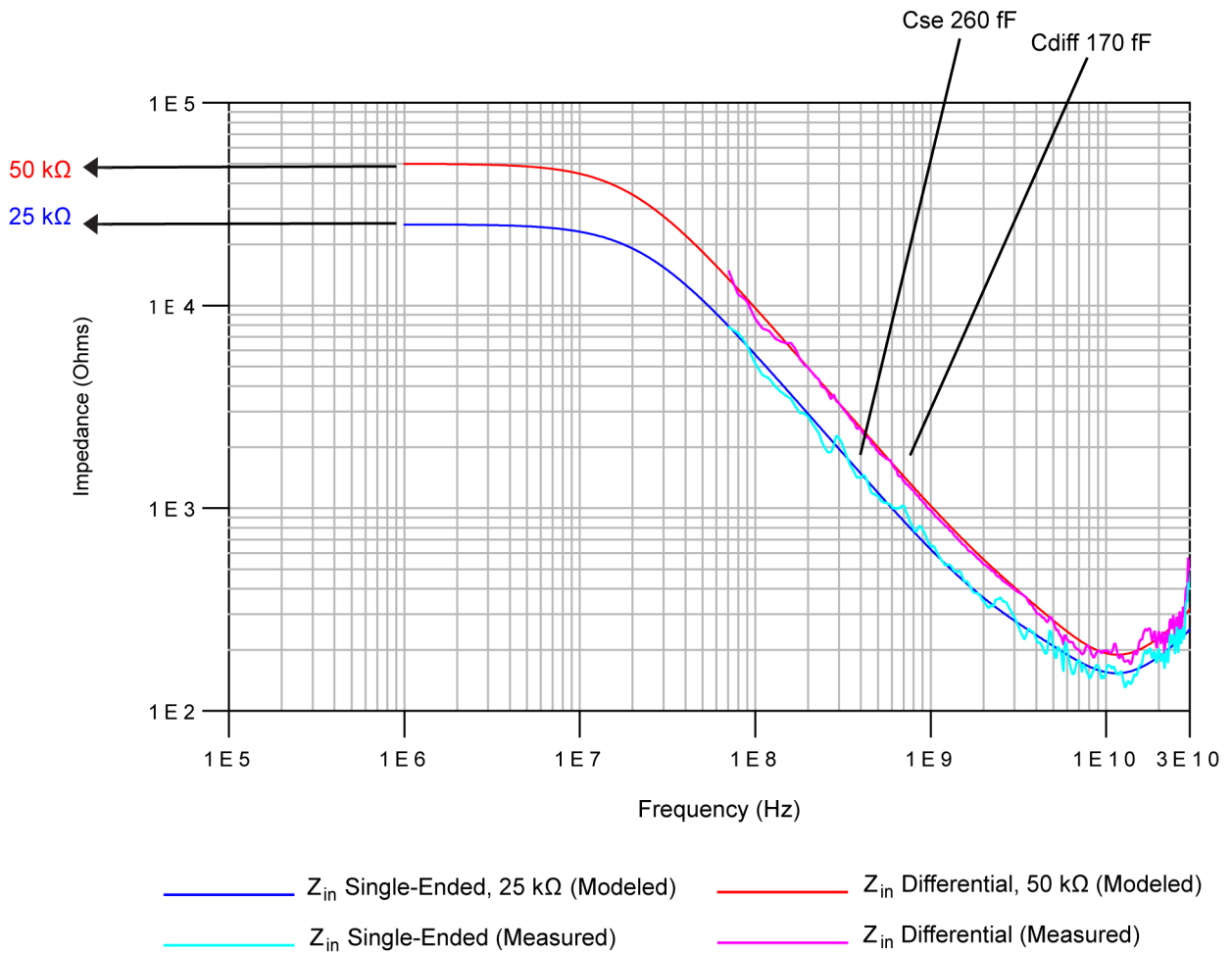
The following SPICE model can be used to predict the probe loading effects of the InfiniiMax RC probe and MX0100A probe head combination.



**Figure 18** SPICE Model for the input impedance of the MX0100A Micro Probe Head

### SPICE Deck and Measured/Modeled Data Matching

```
.subckt MX0100A 1 2
RTipP 1 3 11.58
RTipM 2 4 11.58
C1 3 5 48.86f
L1 5 6 24.79n
R1 6 4 1.589k
Rp1 7 3 88.3
Lp1 8 7 .845n
Cp1 11 8 .223p
Rm1 4 9 88.3
Lm1 9 10 .845n
Cm1 10 11 .223p
Rp2 11 3 25k
Rp3 4 11 25k
RG0 11 12 130.8
L2 12 0 964.6p
L3 11 0 30u
.END
```



**Figure 19** Input Impedances ( $Z_{in}$  Modeled and  $Z_{in}$  Measured) for the MX0100A Probe Head

## Setting up and Using the MX0100A Probe Head

### Trimming the Lead Wires of MX0100A Probe Head

Before soldering, trim the probe head's lead wires matching your DUT's geometry. You can choose from the following lead wire lengths:

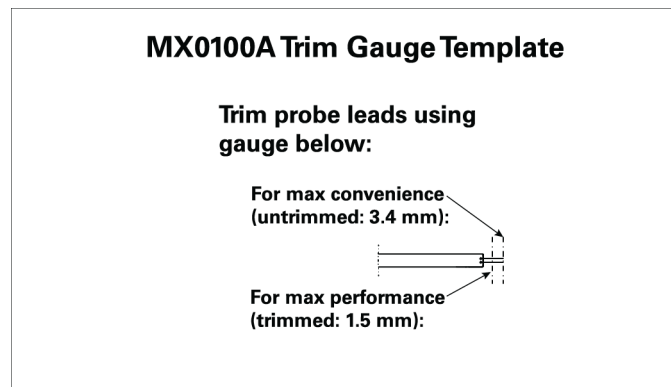
- **135 mil (3.4 mm)** - The probe head is shipped with this factory-trimmed standard length. Use this lead wire length to accommodate variable-pitch targets. With this length, you get the maximum convenience in terms of longer reach with 12 GHz bandwidth but at the expense of more variation in response and higher probe loading.
- **60 mil (1.5 mm)** - If your DUT's geometry allows you to use shorter lead wire length, trim the wires to this length to get the maximum performance and 25 GHz bandwidth. Use this lead wire length to accommodate small fine-pitch targets. The available bandwidth is the full bandwidth of the probe amplifier being used.

#### NOTE

You need to specify your choice of lead wire length (3.4 mm or 1.5 mm) in the Probe Configuration dialog box of the Infiniium software GUI (see [page 126](#)). This allows the software to load the appropriate s parameter file applicable to that wire length. The s parameter file adjusts the frequency response to enhance the measurements accuracy.

#### To properly trim the probe head's lead wires

- 1 Use the Keysight supplied trim gauge template that is included as part of the MX0100A probe head kit.



**Figure 20** MX0100A Trim Gauge Template (MX0100-94302)

- 2 Using tweezers, place the lead wire over the outline of the lead wires as shown on the trim gauge template. The trim gauge template displays two lengths: 3.4 mm and 1.5 mm. Choose the correct length as per your DUT.
- 3 Using the cutting tweezers, trim the lead wires even with the trim lines.



**NOTE**

You can spread the probe head's lead wires within the range of 0mm to 7mm span without causing any significant variation in its available bandwidth.

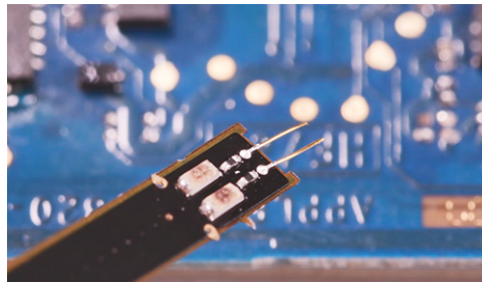
## Soldering an MX0100A Probe Head to DUT

**NOTE**

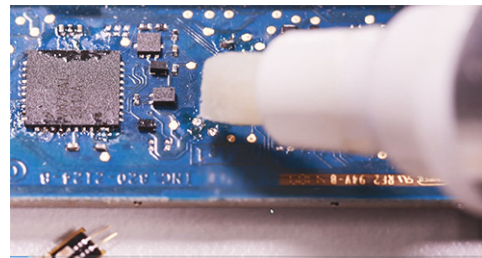
The tools included in the MX0102A soldering toolkit can be of great use while soldering the MX0100A probe head to DUT (see [page 20](#)). You may purchase this toolkit separately.

### To solder the probe tip lead wires to DUT

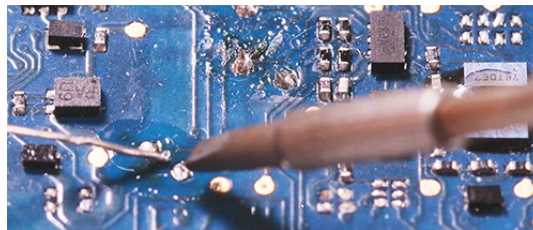
- 1 Trim the length of the MX0100A probe head lead wires to match your DUT's geometry (see [page 56](#)). You may use the cutting tweezers (Keysight part number 8710-2838) included in the Soldering toolkit.



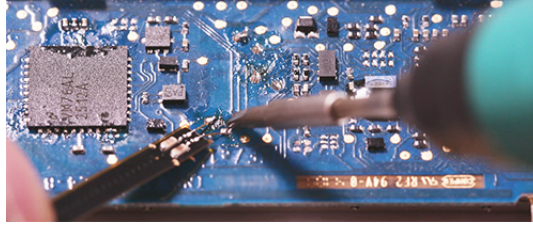
- 2 Apply flux to both DUT and MX0100A probe tip lead wires. Always use plenty of flux, even if your solder already contains flux. This cleans the solder joint and allows for easier flowing solder and quicker dwell times.



- 3 Add solder to existing test points on DUT, if necessary. Heat momentarily and do not dwell any longer than necessary!



- 4 Connect the MX0100A probe head's lead wires to DUT by positioning these wires on DUT and then reflowing joint while heating momentarily. .

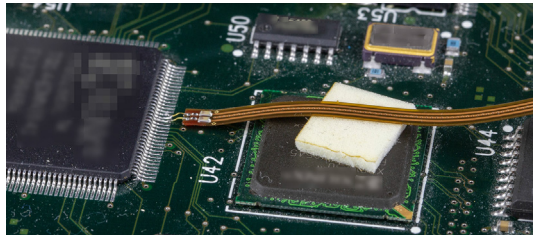


**NOTE**

Keep the temperature as low as possible while still reflowing the solder at the joint of concern. The following are some of the useful tips to maintain low temperature during soldering.

- A temperature-controlled soldering iron is the best way to do this. Set it for no more than 350°C if using standard lead-free solders and 150°C for tin-bismuth solder.
- Do not rest a soldering iron on a probe joint for more than a few seconds.

- 5 Provide strain-relief to the probe head by taping its mid portion to a flat surface such as a tabletop using the double-sided foam tape (such as Keysight part number 0460-3122 included in the MX0102A Soldering Toolkit). You can also use putty, Velcro or low temperature hot glue instead.



- 6 Connect the soldered MX0100A probe head to the InfiniiMax probe amplifier using the supplied MX0103A bullet adapter.



- 7 Provide strain-relief to the probe head and probe amplifier plastic housings by using a double-sided foam tape (Keysight part number 0460-3122 included in the MX0102A Soldering Toolkit)..

**NOTE**

To view a demo on how to solder the lead wires to the DUT, visit <https://prc.keysight.com/> and access the demo under the Videos section.

---

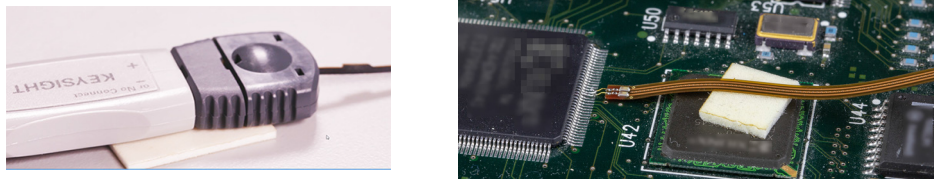
## Maintaining the MX0100A Probe Head

### MX0100A Probe Head Handling Precautions

One of the advantages of the MX0100A probe head is its reusability feature. This section describes some of the cautions and tips on how to properly handle the MX0100A probe head to prevent damage and maintain high performance and reusability of the probe head.

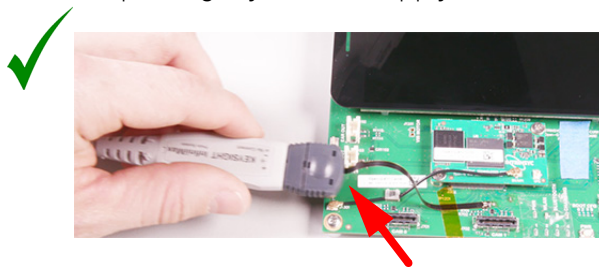
#### To prevent damage and ensure reusability of the MX0100A probe head

- After you have connected the MX0100A probe head electrically to a DUT via solder, it is best to secure it mechanically as well. Always provide strain relief to the probe head setup using putty, velcro, low temperature hot glue, or double-sided foam tape to prevent any unnecessary strain to the probe head and to protect delicate connections.
- Strain relief is recommended at the probe head and amplifier housings as well as at the probe head cable.

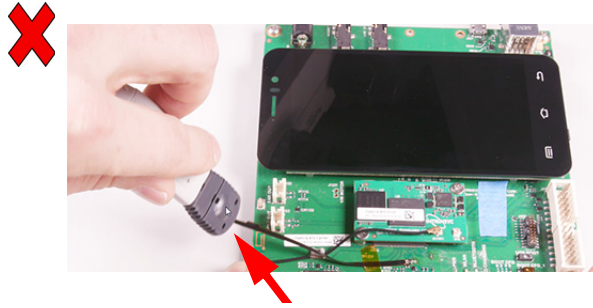


**Figure 21** Example of a properly strain-relieved MX0100A probe head setup

- While moving a soldered MX0100A probe head, always ensure that you do not twist, pull, tightly bend, or apply force near the probe head's cable housing.



**Figure 22** Example of correct movement of MX0100A probe head



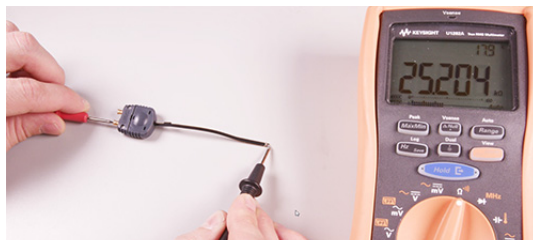
**Figure 23** Example of incorrect movement of MX0100A probe head

- Use a microscope setup while performing soldering/de-soldering tasks. A microscope with the following features is recommended.
  - Binocular eyepieces
  - Adjustable magnification (at least 20x)
  - Good working distance from the sample (at least 4 inches)
  - Adjustable arm
  - Integrated ring light around the objective lens
- Ensure that there is less thermal stress on the probe head as well as DUT by:
  - Using a high quality temperature controlled soldering iron with the tip temperature set as low as possible (just high enough to melt the alloy).
  - Using a low temperature solder alloy such as SAC (Tin / Silver / Copper) with 220 °C melting point), or tin-bismuth solder with 138 °C melting point.
- Do not apply heat on the probe tip leads for a time period longer than two seconds.
- Use a small solder iron tip (<1mm is recommended).
- No clean (non-conductive) and less acidic flux is recommended.
- While disconnecting the probe head from the MX0103A bullet adapter:
  - either gently pull the bullet adapter from the probe head by hand
  - or engage a flat screwdriver on the notch provided on the bullet adapter and gently disconnect the probe head from bullet adapter.



**To check the MX0100A probe head for any damage**

You can use a Digital Multimeter to check the resistance measurement of your MX0100A probe head. If the resistance measurement between the probe head's tip and the center conductor of the SMP connector is ~25.2 kohm, then the probe head is usable.



**Figure 24** Resistance measurement for an undamaged MX0100A probe head

For a damaged probe head, the resistance measurement between the MX0100A probe head tip wire and the center conductor of the SMP connector of the MX0100A is displayed as Infinite.



**Figure 25** Resistance measurement for a damaged MX0100A probe head

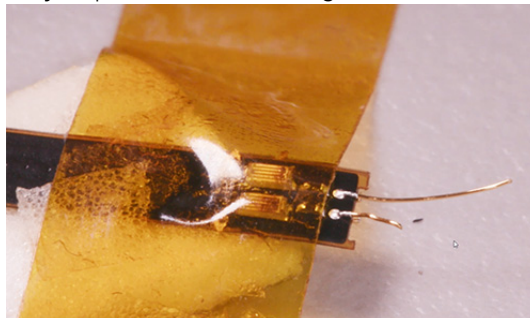
## Replacing the MX0100A Probe Tip Lead Wires

The MX0100A probe head comes equipped with replaceable resistor tips. If these resistor tips break, you can replace the tips without having to replace the entire probe head or having to send it back for repair. This section shows you how to install or repair the leads wires on the MX0100A probe head. Depending on your probing application, you can order either 9 mil or 10 mil solder wire as listed in the following table. These wires are also included in the *Keysight MX0102A Soldering Toolkit* (see [page 20](#) for details).

**Table 13** Required Wire Types

Wire Type	Wire Diameter	Part Number
Regular Solder Wire (lead free) Requires standard lead-free soldering temperatures (330 °C to 350 °C). <b>(NOTE: This alloy melts at 217 °C.)</b>	.009" diameter	MX0102-21302
Low Temperature Solder Wire (lead free) Requires a low temperature setting on your soldering iron. <b>(NOTE: This alloy melts at 138 °C.)</b>	.010" diameter	MX0102-21303

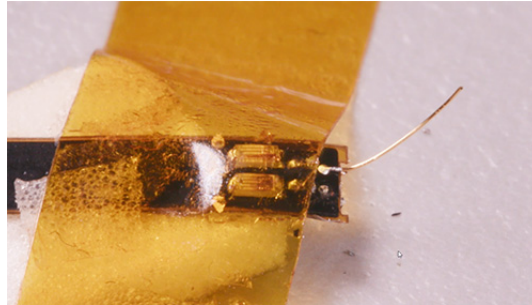
- 1 Secure the tip of the MX0100A probe head on a raised off position from the table. You may use a double-sided foam tape (Keysight part number 0460-3122 included in the MX0102A Soldering Toolkit). Keep the lead wires solder joints off the raised base to facilitate soldering. Cover the entire probe head tip with Kapton tape while ensuring that the lead wires solder joints are fully exposed for soldering.



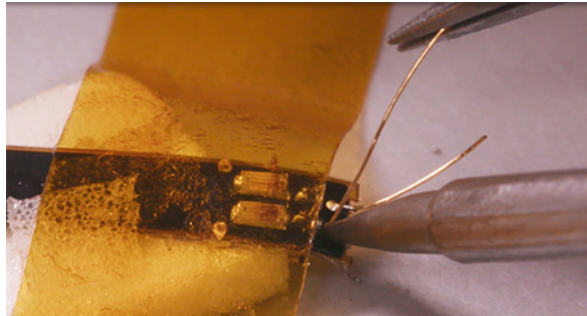
- 2 Remove the damaged lead wire from the via by grabbing it with tweezers and pulling up very gently. Touch the soldering iron to the solder joint just long enough for the lead wire to come free of the probe head tip.

### CAUTION

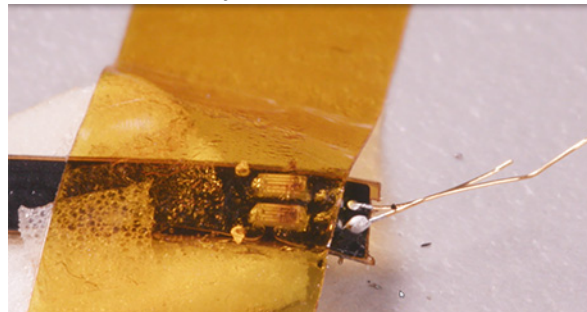
To avoid burning and damage to the probe head, do not keep the soldering iron in contact with the tip any longer than necessary. The solder joint quickly melts and releases the wire.



- 3** Position the end of the new lead wire (Keysight part number MX0102-21302 or MX0102-21303 included in the MX0102A Soldering Toolkit) over the via hole. Touch the soldering iron to the side of the hole. As the solder in the hole melts down, the lead wire will fall into the hole. Remove soldering iron as soon as the lead wire falls into the hole.

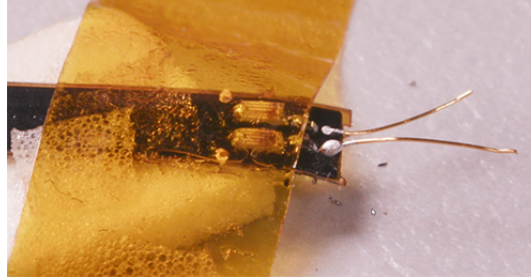


- 4** Apply flux on the solder joint and then apply a small amount of solder to the tip of the soldering iron. Touch the solder tip (with the solder on it) to the solder joint. Do not dwell on the joint with the solder iron any longer than needed. The solder should flow off the soldering iron tip into the joint. If it does not flow, then sufficient flux may not have been used.

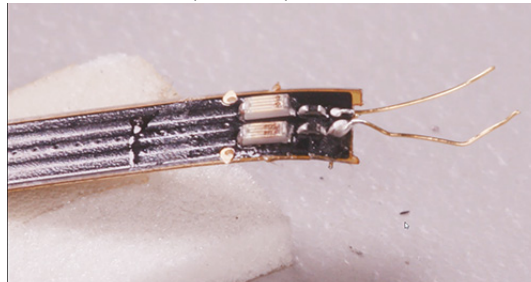




- 5 Cut the extra wire off using a cutting tweezer (Keysight part number 8710-2838 included in the MX0102A Soldering Toolkit).



- 6 Remove the Kapton tape.



## Extreme Temperature Testing with the MX0100A Probe Head

The MX0100A probe head can withstand temperatures from  $-55^{\circ}\text{C}$  to  $+150^{\circ}\text{C}$  thereby making it suitable for extreme temperature environments such as temperature chambers. For extreme temperature testing, use the MX0100A probe head with the N5450B InfiniiMax extreme temperature extension cable.

### CAUTION

InfiniiMax probe amplifiers cannot withstand extreme temperatures ( $-55^{\circ}\text{C}$  to  $+150^{\circ}\text{C}$ ) that the MX0100A probe head can withstand. Be cautious not to subject these probe amplifiers to extreme temperatures. Using the N5450B extension cable with the MX0100A probe head physically separates the amplifier from the probe head and therefore eliminates the chances of the amplifier's exposure to extreme temperatures.

---

To know more about how to use MX0100A in extreme temperatures and the associated cautions, refer to **"Extreme Temperature Probing"** on page 139.

## 7 MX0106A InfiniiMax Differential Solder-in Probe Head



Overview	68
MX0106A Probe Head Supplied Accessories	68
MX0106A Dimensions	68
MX0106A Input Impedance	70
Setting up and Using the MX0106A Probe Head	73
Adjusting the Spacing between MX0106A Wires	73
Installing / Replacing the MX0106A Probe Head Wire Leads	73
Connecting the MX0106A Probe Head to DUT	77
Soldering the MX0106A Probe Head to DUT	78
Extreme Temperature Testing with the MX0106A Probe Head	79

## Overview



The MX0106A probe head allows a soldered connection into a system for a reliable hands-free probing. This probe head configuration provides 23 GHz bandwidth and a low capacitive loading for measuring both single-ended and differential signals.

For connection to a DUT, this probe head uses strong 7 mil (or optional 4 mil) diameter nickel wires that allow solder-in connection to very small, fine pitch targets.

The solder-in head allows for wide operating temperature of -55 °C to +150 °C.

See [page 43](#) for characteristics and specifications of MX0106A probe head and MX0023A probe amplifier.

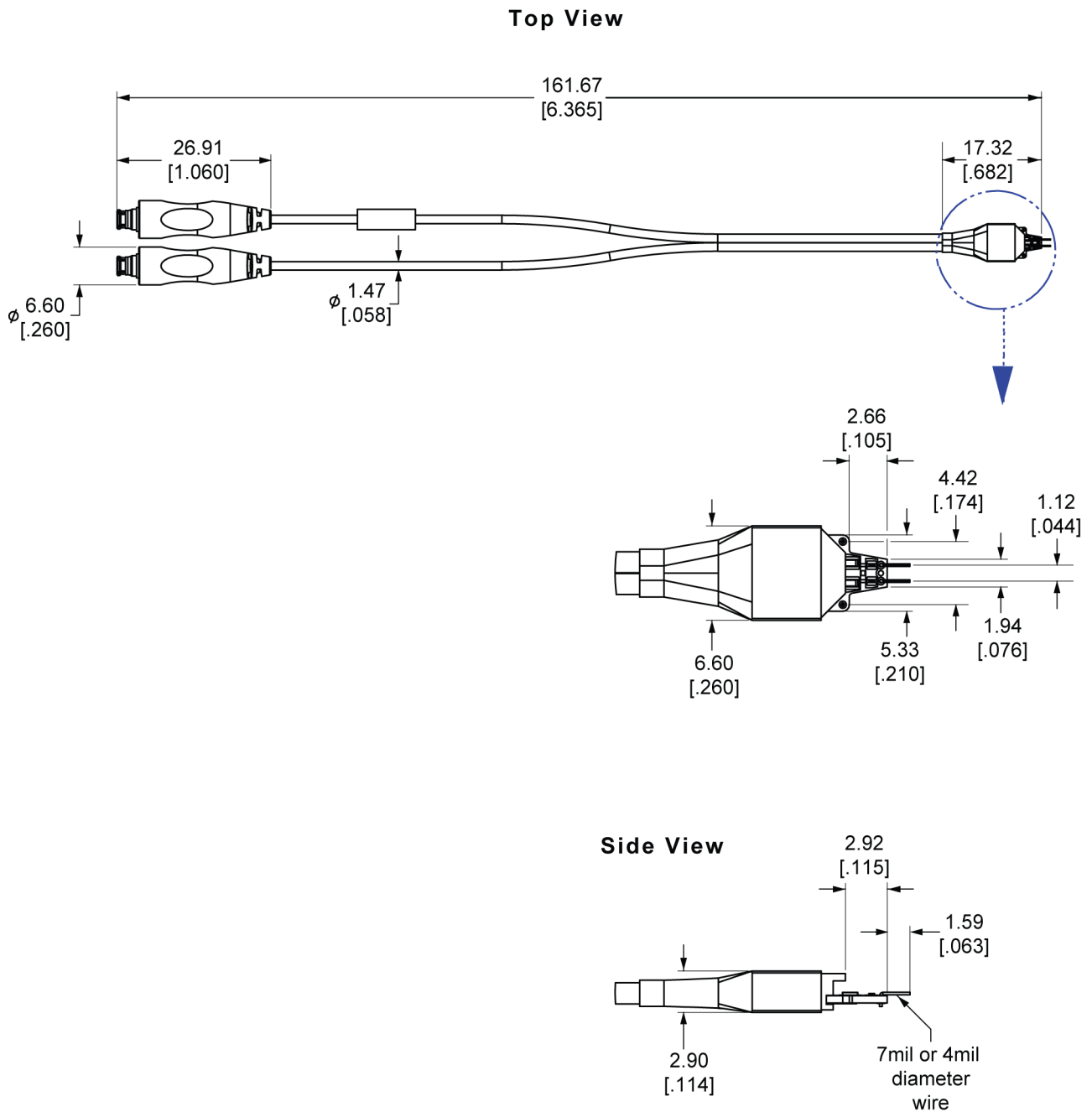
### MX0106A Probe Head Supplied Accessories

**Table 14** Supplied Accessories

Accessory	Quantity	Part Number
0.007 inch tin-plated nickel wire kit <i>(Includes wire and trim gauge)</i>	1	01169-81301
0.004 inch tin-plated nickel wire	1	MX0102-21301

### MX0106A Dimensions

All dimensions in the figure below are in mm [inches].



**Figure 26** MX0106A Probe Head Dimensions

## MX0106A Input Impedance

**NOTE**

Input impedance is a function of the probe head only. The probe amplifier bandwidth (25 GHz) does not have any effect on the input impedance of the probe head.

---

This section provides:

- the SPICE model for MX0106A. This SPICE model is only for input impedance which allows modeling of the probe loading effects. Probe transfer function is generally flat to the specified bandwidth.
- an input impedance plot for MX0106A to show the matching of the measured data to the modeled data. Matching is generally very good up to the specified bandwidth of the probe head.

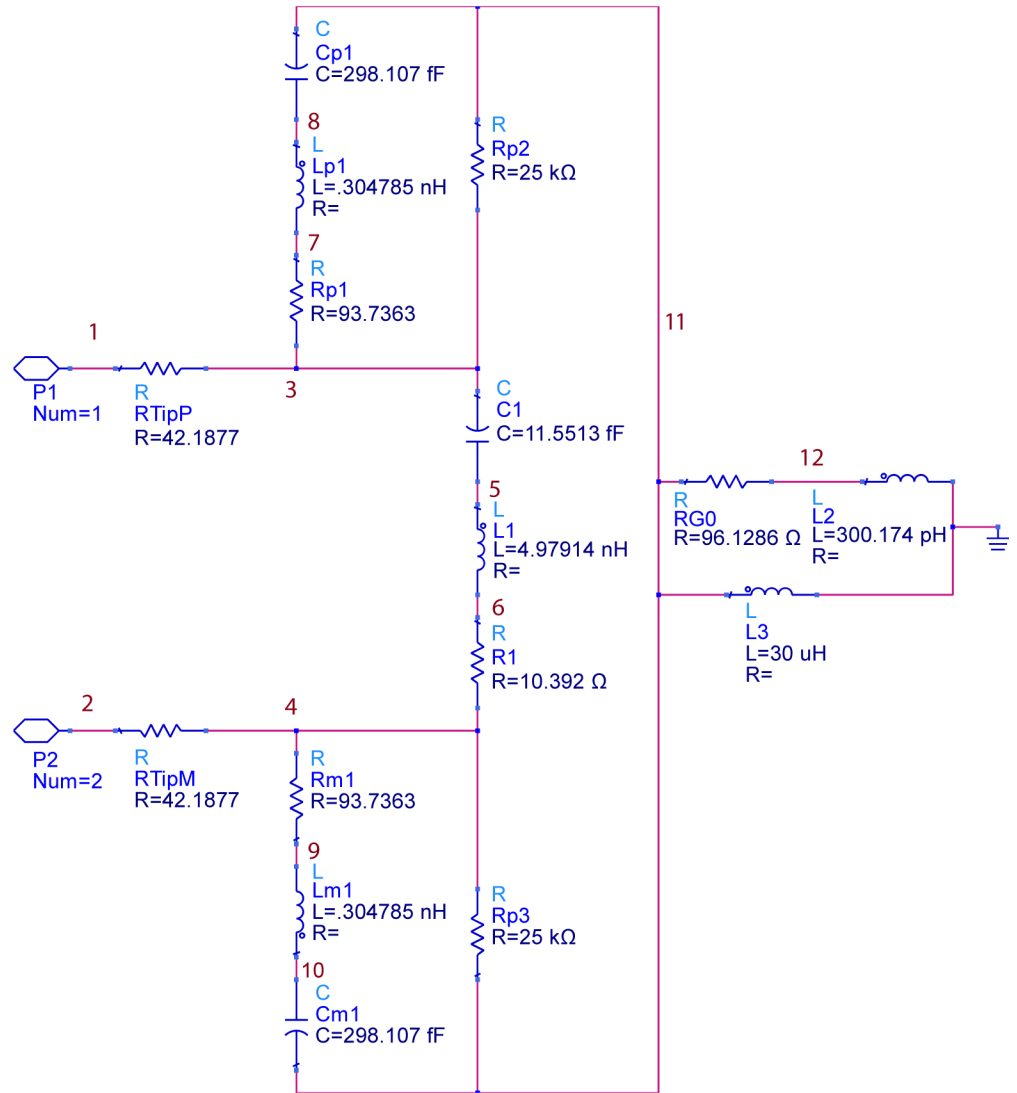
**NOTE**

Refer to the chapter **"InfiniiMax RC Probe Amplifier and Probe Heads System Responses"** on page 143 to get a typical corrected frequency response and CMRR for the MX0023A probe amplifier and probe head combination.

---

### MX0106A SPICE Model

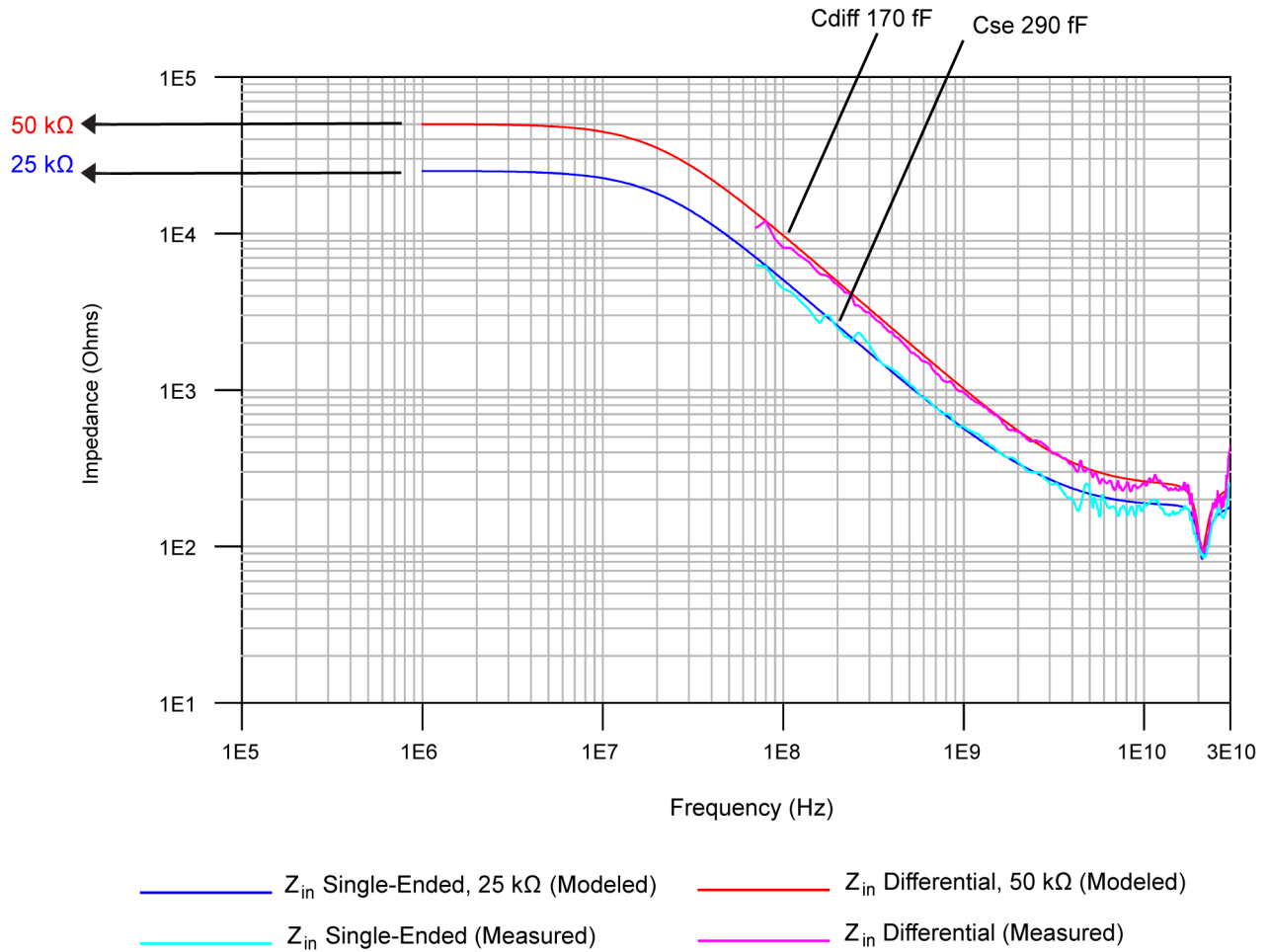
The following SPICE model can be used to predict the probe loading effects of the InfiniiMax RC probe and MX0106A probe head combination.



**Figure 27** SPICE Model for the input impedance of the MX0106A Probe Head

### SPICE Deck and Measured/Modeled Data Matching

```
.subckt MX0106A 1 2
RTipP 1 3 42.1877
RTipM 2 4 42.1877
C1 3 5 11.5513f
L1 5 6 4.97914n
R1 6 4 10.392k
Rp1 7 3 93.7363
Lp1 8 7 .304785n
Cp1 11 8 298.107f
Rm1 4 9 93.7363
Lm1 9 10 .304785n
Cm1 10 11 298.107f
Rp2 11 3 25k
Rp3 4 11 25k
RG0 11 12 96.1286
L2 12 0 300.174p
L3 11 0 30u
.END
```



**Figure 28** Input Impedances (Z<sub>in</sub> Modeled and Z<sub>in</sub> Measured) for the MX0106A Probe Head



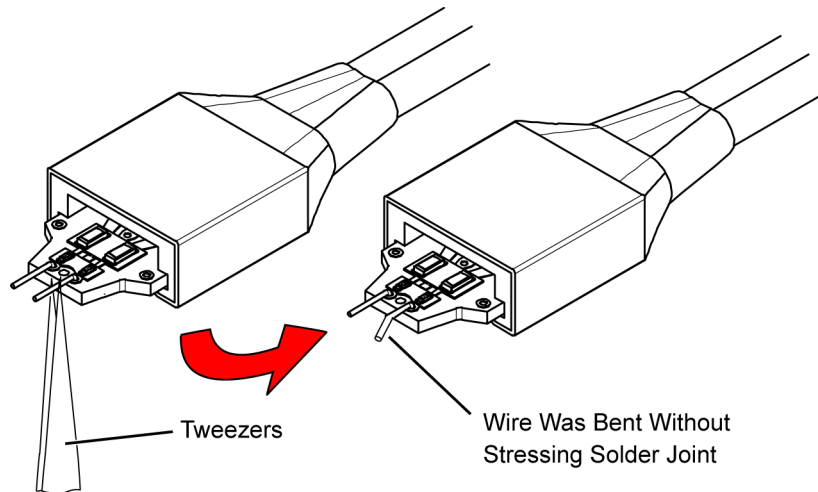
## Setting up and Using the MX0106A Probe Head

### Adjusting the Spacing between MX0106A Wires

**Figure 29** shows how to adjust the spacing of the probe head's wires without stressing the solder joint.

#### CAUTION

Use tweezers to grab and stabilize the lead near the pc board edge. Then, without moving the tweezers, position the wires as needed. Stabilizing the wire near the solder joint reduces stress at the solder joint. The wires will then last much longer with multiple adjustments.



**Figure 29** Adjusting Spacing Without Stressing Solder Joint

#### NOTE

The span of leads can be adjusted from 8 to 130 mils (0.2 mm - 3.3 mm).

### Installing / Replacing the MX0106A Probe Head Wire Leads

The lead wires of the MX0106A probe head are replaceable.

The following two types of wires are available for installation/replacement on the MX0106A probe head tip.

**Table 15** Required Wire Type

Wire Diameter	Part Number
0.007 inch (tin-plated nickel wires)	01169-81301
0.004 inch (tin-plated nickel wires)	MX0102-21301

**Table 16** Recommended Equipment

Equipment
Vise or clamp for holding tip
Metcal STTC-022 (600 °C) or STTC-122 (700 °C) tip soldering iron or equivalent. The 600 °C tip will help limit burning of the FR4 tip PC board.
0.381 mm (0.015 in) diameter RMA flux standard tin/lead solder wire
Fine stainless steel tweezers
Rosin flux pencil, RMA type (Kester #186 or equivalent)
Flush cutting wire cutters
Magnifier or low power microscope
Keysight supplied trim gauge (01169-23801)

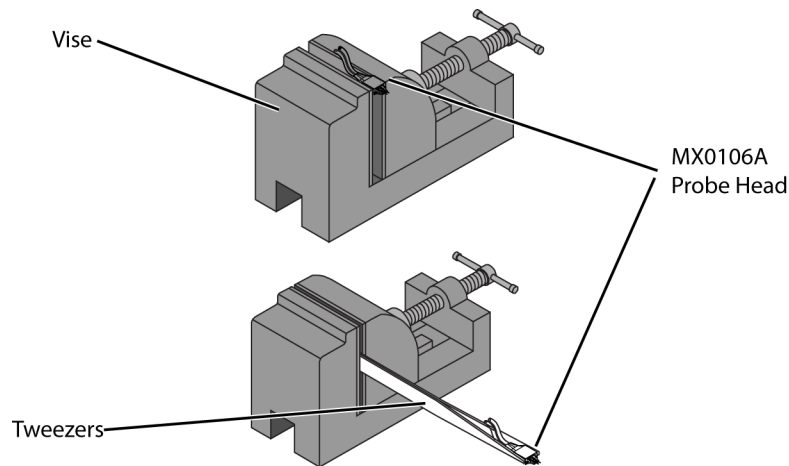
Use the following procedure to install or replace the wire leads of the MX0106A probe head.

- 1 Use the vise or tweezers clamp to position the tip an inch or so off the work surface for easy access.

**CAUTION**

If using a vise, grip the probe head tip on the sides with light force. When tightening the vise, use light force to avoid damaging the solder-in probe head.

If using a tweezers clamp, grip the probe head tip either on the sides or at the top and bottom.



**Figure 30** Clamping the MX0106A Probe Head

- 2 If you need to replace an existing or a damaged wire lead, grab it with tweezers and pull it gently up. Touch the soldering iron to the solder joint just long enough for the wire to come free of the probe head tip. The solder joint has very low thermal mass, so the joint quickly melts and releases the wire.

**CAUTION**

When replacing the wire leads of MX0106A, be cautious not to keep the soldering iron in contact with the probe head tip any longer than needed to avoid reflowing the components during the procedure.

---

Applying heat from the underside of the probe can help in preventing the soldering joint to be undone from the components closer to the wire leads.

---

**NOTE**

Make sure the soldering iron tip is free of excess solder.

---

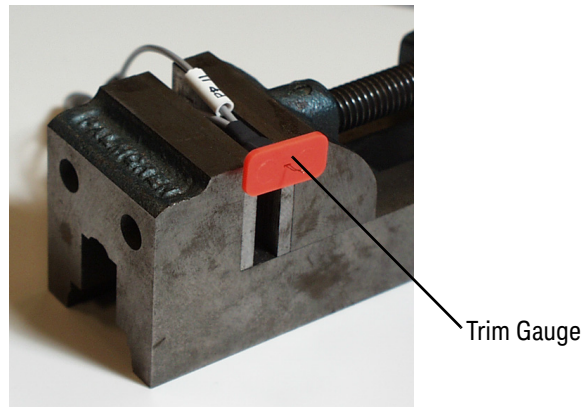
- 3 If needed, fill the mounting hole with solder in preparation for the new wire.
- 4 Use the flux pencil to coat the solder joint area with flux.
- 5 Cut two wires to a length of about 12.7 mm (0.5 inches).
- 6 Using tweezers, put a 90° bend at the end of the wire. Leave enough wire at the bend such that it will protrude through the board when the wire is installed.
- 7 Holding the wire in one hand and the soldering iron in the other hand, position the end of the wire lead over the solder filled hole. Touch the soldering iron to the side of the hole. When the solder in the hole melts, the wire lead will fall into the hole. Remove soldering iron as soon as the lead falls into the hole.

**CAUTION**

The thermal mass of the joint is very low, so taking extra time with the soldering iron in an attempt to ensure a good joint is not needed.

---

- 8 Cut the wires that protrude on the bottom side of the probe head board even with the solder pad.
- 9 Place the wires through the hole in the supplied trim gauge with the probe head perpendicular to the trim gauge.



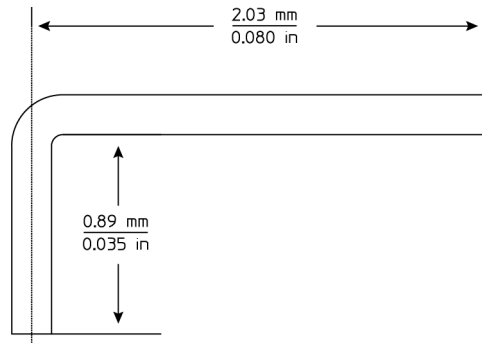
**Figure 31** Trim Gauge on Probe Head

**10** Cut the wires even with the trim gauge on the side opposite to the probe head.



**Figure 32** Cutting Wires Flush with Gauge

Each wire lead needs to be trimmed to 0.89 mm to fit the hole in the pc board as shown in the following figure.



**Figure 33** Wire Lead Trim Dimensions

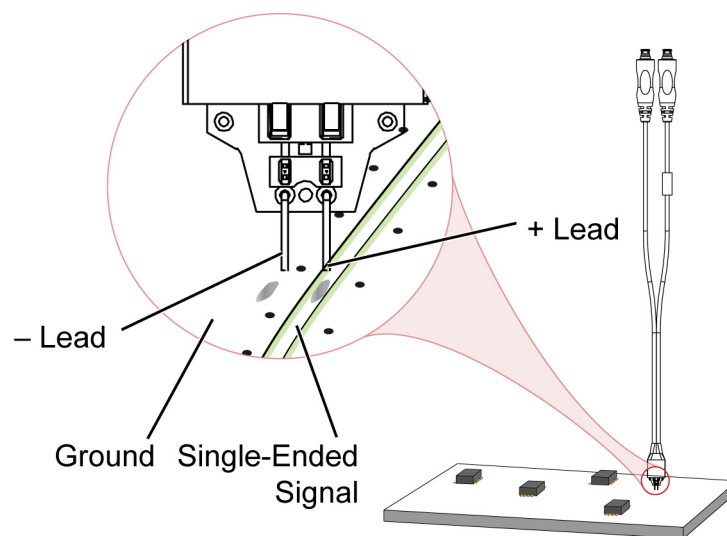
## Connecting the MX0106A Probe Head to DUT

### NOTE

The + and - connection for the MX0106A probe head can be determined when the probe head is plugged into the probe amplifier. The polarity markings on the probe amplifier represent the + and - inputs on the MX0106A probe head. Therefore, it does not matter which way the MX0106A tip is soldered.

When probing single-ended signals:

- ensure that the - input of the probe amplifier is connected to the ground of the DUT.
- orient the MX0106A probe head vertically. Laying the probe head flat causes coupling to the probe head tip that can degrade the probe performance.



## Soldering the MX0106A Probe Head to DUT

**CAUTION**

Always mechanically strain-relieve the probe head to protect your probing equipment and DUT from damage. Refer to **“Strain Relieving Techniques for Probe Heads”** on page 37.

---

- 1 Apply flux to your target leads. The flux ensures a good and strong solder joint without having to use an excessive amount of solder.
- 2 Tin the leads with a small amount of solder.
- 3 Use tweezers to form the probe head wires to fit your DUT's geometry.
- 4 Apply flux to the DUT leads and your probe head wires.
- 5 Position the probe head wires on the DUT leads and quickly re-flow the solder.

**CAUTION**

Do not leave the soldering iron in contact with the probe head for more than a few seconds at a time.

---

For additional tips, refer to the topic **“Tips for Soldering Probe Heads”** on page 40.

## Extreme Temperature Testing with the MX0106A Probe Head

The MX0106A probe head can withstand temperatures from  $-55^{\circ}\text{C}$  to  $+150^{\circ}\text{C}$  thereby making it suitable for extreme temperature environments such as temperature chambers. For extreme temperature testing, use the MX0106A probe head with the N5450B InfiniiMax extreme temperature extension cable (see [page 19](#)).

### CAUTION

InfiniiMax probe amplifiers cannot withstand extreme temperatures ( $-55^{\circ}\text{C}$  to  $+150^{\circ}\text{C}$ ) that the MX0106A probe head can withstand. Be cautious not to subject these probe amplifiers to extreme temperatures. Using the N5450B extension cable with the MX0106A probe head physically separates the amplifier from the probe head and therefore eliminates the chances of the amplifier's exposure to extreme temperatures.

---

To know more about how to use MX0106A in extreme temperatures and the associated cautions, refer to "[Extreme Temperature Probing](#)" on page 139.





## 8 N2839A InfiniiMax II Browser Probe Head



Overview	82
N2839A Browser Probe Head Components	82
N2839A Supplied Accessories	82
N2839A Dimensions	84
N2839A Input Impedance	84
Using the N2839A Browser Probe Head	88
Adjusting Spacing Between the Browser Tips	88
Hands-Free Probing	88
N2839A Probe Head Handling Precautions	90
Location of Serial Number	90
Replacing the Browser's Tips	91

## Overview



The N2839A differential browser is the best choice for signals browsing and general purpose troubleshooting of a circuit board. This probe head supports a bandwidth of 21 GHz when used with the MX0023A InfiniiMax RC probe amplifier. The probe head's high bandwidth performance, adjustable tips, and ergonomic design makes it ideal for hand held measuring of differential and single-ended signals.

See [page 43](#) for characteristics and specifications of N2839A probe head and MX0023A probe amplifier.

### N2839A Browser Probe Head Components



**Figure 34** N2839A Browser Probe Head Components

### N2839A Supplied Accessories

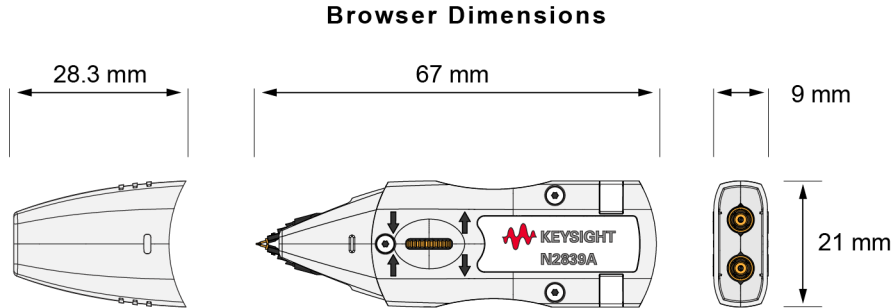
Accessory	Quantity	Description
Straight probe tips (0.003 in. diameter, 0.113 in. long)	20	Straight tips are rigid but provide more robust contact.

Accessory	Quantity	Description
Spring-loaded tips (0.0115 in. diameter, 0.126 in. long)	20	Spring-loaded tips are less susceptible to vibration or movement than straight tips and provide more stable spring-loaded contact. Spring-loaded tips work best when these are either partially or fully compressed and are protected against over compression damage.
Tweezers	1	ESD safe tweezers to replace tips. Refer to the topic <b>"Replacing the Browser's Tips"</b> on page 91 to know more.
Protective end cap	1	Keep the protective end cap on the browser when the browser is not in use.

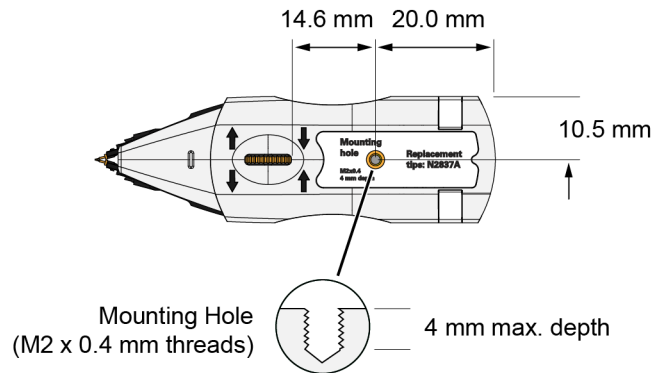
**NOTE**

To purchase additional tips, order the N2837A kit that contains 20 spring-loaded tips and 20 straight tips.

## N2839A Dimensions



### Probe Positioner Mounting Hole



## N2839A Input Impedance

**NOTE**

Input impedance is a function of the probe head only. The probe amplifier bandwidth (25 GHz) does not have any effect on the input impedance of the probe head.

This section provides:

- the SPICE model for N2839A. This SPICE model is only for input impedance which allows modeling of the probe loading effects. Probe transfer function is generally flat to the specified bandwidth.
- an input impedance plot for N2839A to show the matching of the measured data to the modeled data. Matching is generally very good up to the specified bandwidth of the probe head.

**NOTE**

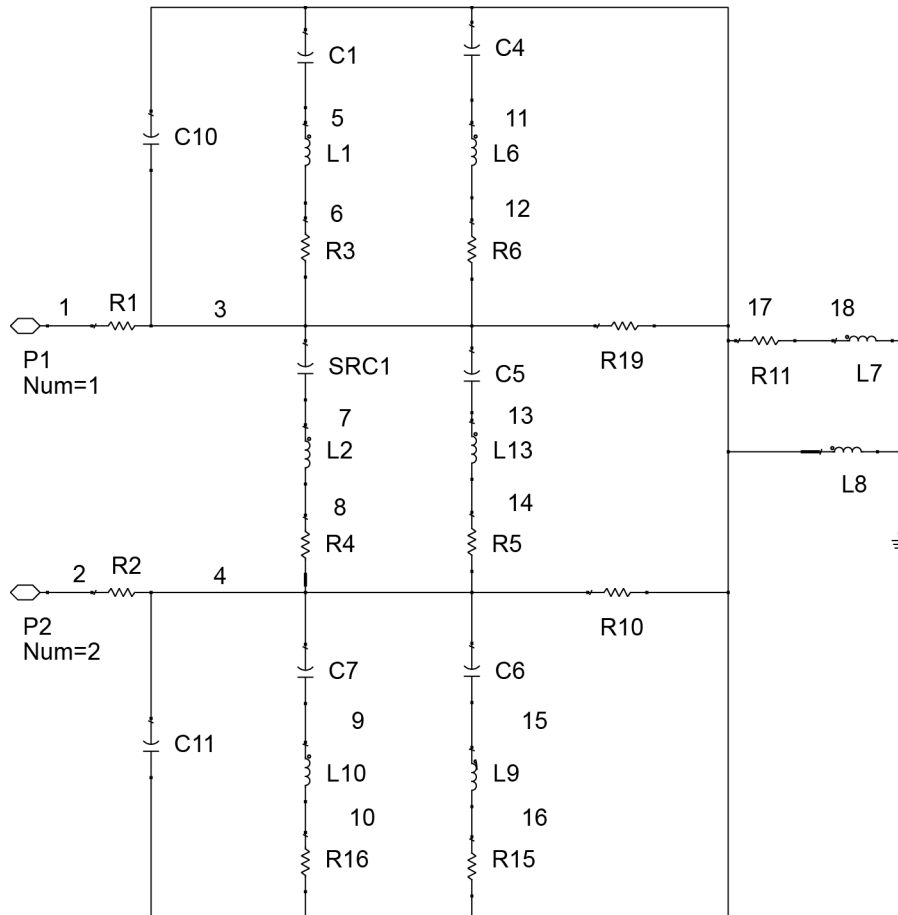
Refer to the chapter “**InfiniiMax RC Probe Amplifier and Probe Heads System Responses**” on page 143 to get a typical corrected frequency response and CMRR for the InfiniiMax RC probe amplifier and probe head combination.

**N2839A SPICE Model**

The following SPICE model can be used to predict the probe loading effects of the N2839A probe head.

**NOTE**

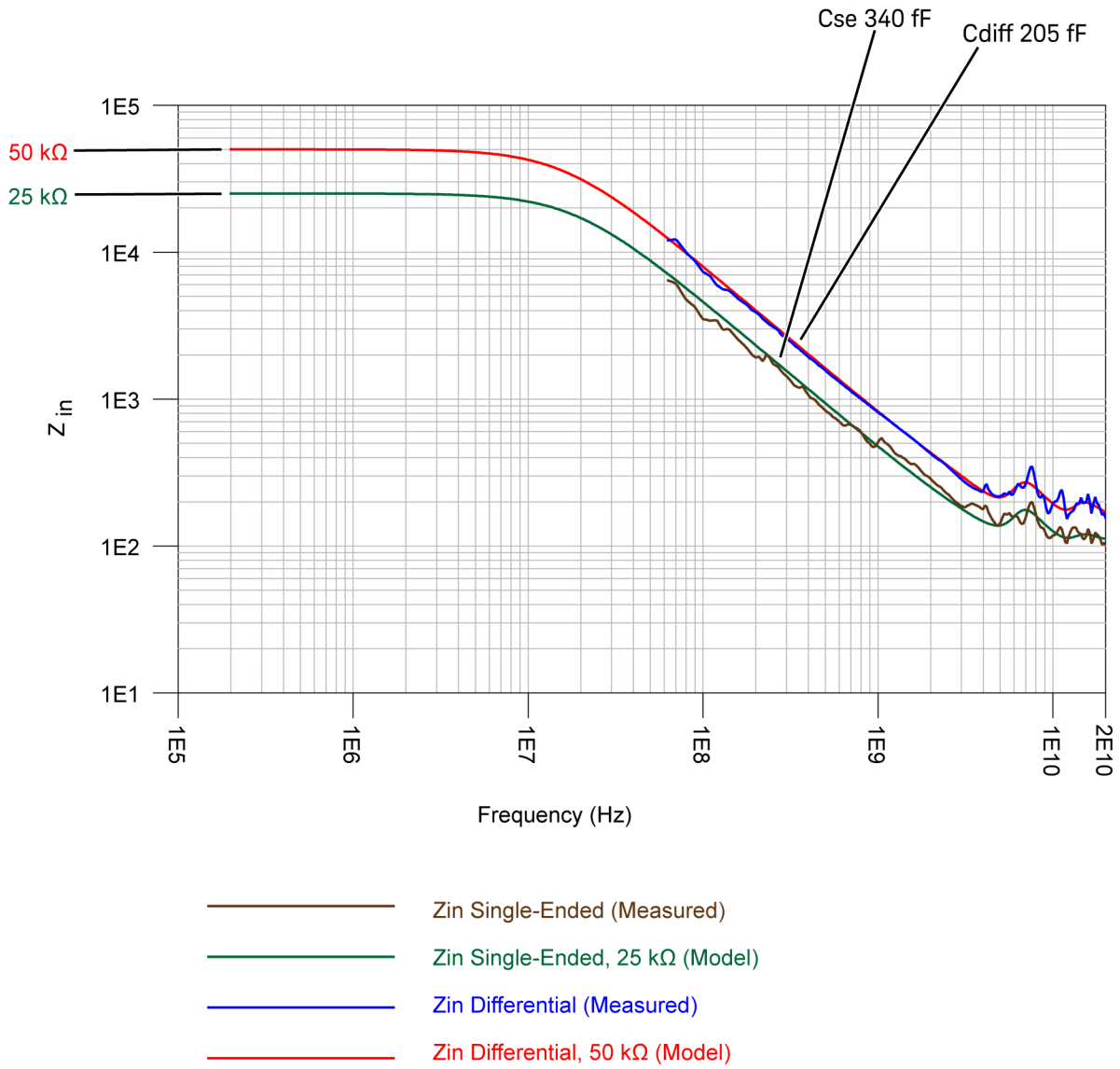
The S-parameters and spice models for the N2839A probe head remain the same for the spring-loaded tips and straight tips supplied with the browser.



**Figure 35** SPICE Model for the input impedance of the N2839A Browser Probe Head

## SPICE Deck and Measured/Modeled Data Matching

```
* Input impedance SPICE subckt for probe head listed.  
.subckt N2839A 1 2  
r1 1 3 41.09  
r2 2 4 41.09  
c10 3 17 95.34f  
c11 4 17 95.34f  
c1 17 5 100f  
c7 4 9 100f  
l1 5 6 8.126n  
l10 9 10 8.126n  
r3 6 3 139.7  
r16 10 17 139.7  
csrc1 3 7 35.6f  
l2 7 8 4.03n  
r4 8 4 1553.6  
c4 17 11 93.1f  
c6 4 15 93.1f  
l6 11 12 .164n  
l9 15 16 .164n  
r6 12 3 71.92  
r15 16 17 71.92  
c5 3 13 17.68f  
l13 13 14 8.6n  
r5 14 4 273.2  
r19 3 17 25k  
r10 4 17 25k  
r11 17 18 40.54  
l7 18 0 .205n  
l8 17 0 47.23u  
ends
```

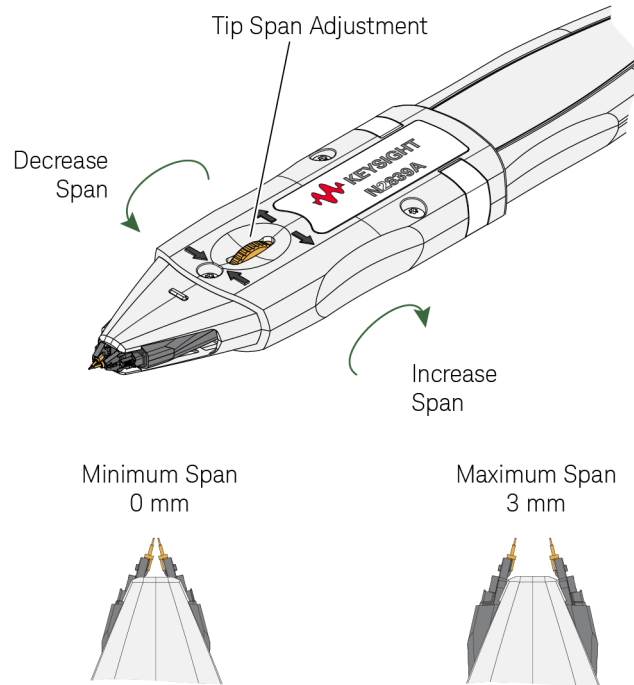


**Figure 36** Input Impedances ( $Z_{in}$  Modeled and  $Z_{in}$  Measured) for the N2839A Probe Head

## Using the N2839A Browser Probe Head

### Adjusting Spacing Between the Browser Tips

The spacing between the N2839A's tips can be adjusted from 0 mm to 3 mm using the adjustment wheel shown in **Figure 37**.



**Figure 37** Adjusting the Tip Spacing

#### NOTE

The tip span setting does not impact the probe head's frequency response.

### Hands-Free Probing

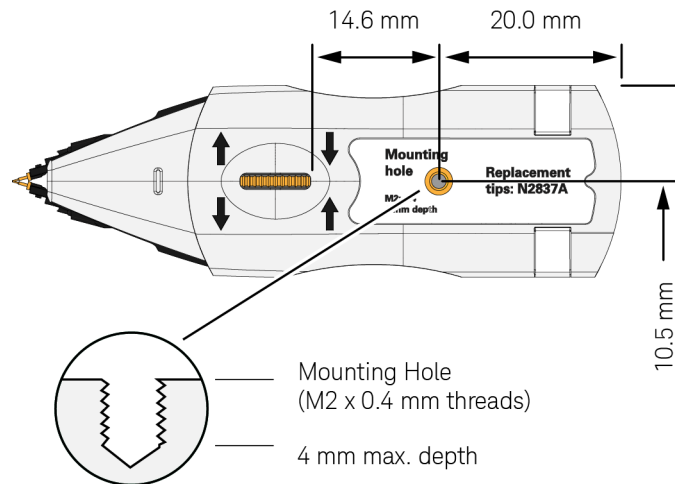
For hands-free stability, you can:

- either mount the N2839A browser on an N2784/5A or N2787A probe positioner as displayed in the following figure.





- or construct a custom holder using the mounting dimensions shown in the following figure. Use a M2 x 4 mm thread screw to attach the probe head.



**Figure 38** Location and Dimensions of Mounting Hole

**CAUTION**

Do not allow the mounting screw to penetrate more than 4 mm into the browser’s mounting hole. Torque the mounting screw to 0.09 Nm (0.8 lb-in.).



## Maintaining the N2839A Probe Head

### N2839A Probe Head Handling Precautions

This section describes some of the cautions, warnings, and tips on how to properly handle and use the N2839A probe head to prevent damage/injury and maintain high performance and reusability of the probe head.

#### WARNING

**As the probe head tips are sharp, handle the N2839A with care to avoid injury.**

---

#### CAUTION

When a tip is damaged, do not continue probing. Failure to replace the tip can result in permanent damage with the tip lodged into the tip arm's socket. Refer to the topic **"Replacing the Browser's Tips"** on page 91.

---

#### CAUTION

When the N2839A browser is not in use, always snap the protective end cap onto the browser to protect the delicate browser tips. The physics of designing tips for high frequency, accurate measurements requires that the tip dimensions remain small.

---

#### CAUTION

When probing, do not apply a side load to the browser, which might result in damaged tips.

---

#### Probing tips

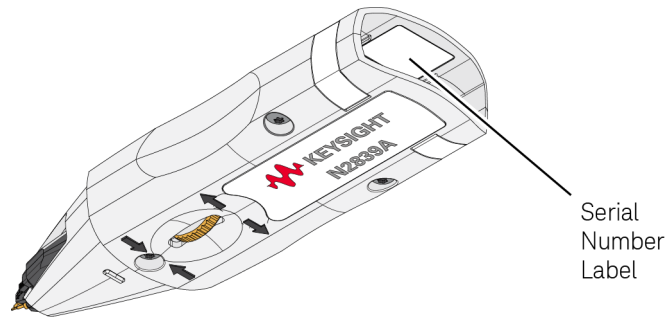
When probing, observe the following tips:

- Compress the probe tips against the measurement point by applying gentle pressure along the probe's axis.
- When possible, hold the browser vertical and perpendicular to the circuit board.

### Location of Serial Number

When sending the probe head for repair or service, you need the serial number of the probe head.

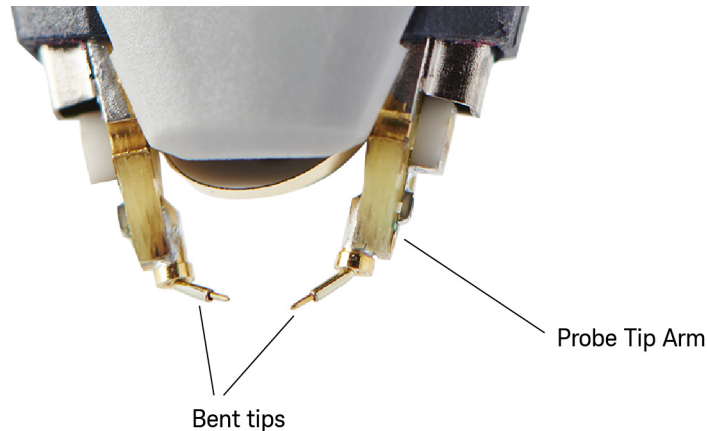
The N2839A's serial number is located inside the browser's head-to-amplifier connection as shown in the following figure.



**Figure 39** Location of Serial Number Label

## Replacing the Browser's Tips

Use the following procedure to install or replace the tips on the N2839A probe head. Replacement tips are supplied with the browser. For additional tips, you can order the N2837A replacement tip kit.



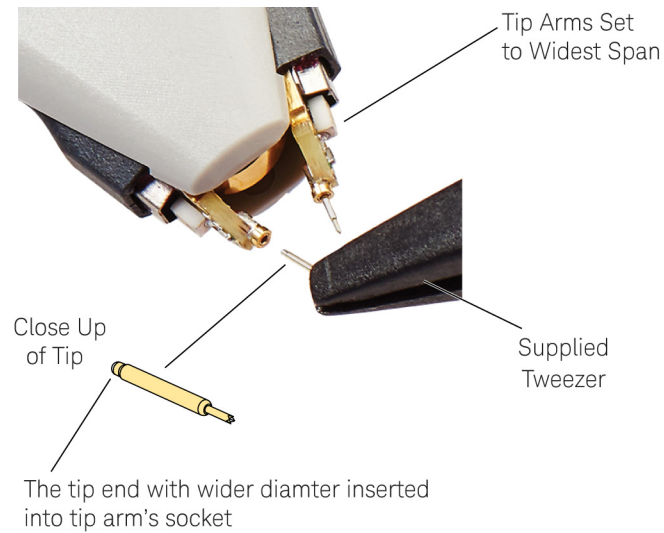
**Figure 40** Example of damaged tips

- 1 Adjust the browser's tip span adjustment wheel so that the tip span is set to its maximum range.
- 2 To remove an existing tip, use your fingers or the supplied ESD-safe tweezers. Gently pull the tip straight out of the browser. Do not twist or turn the tip.
- 3 Pick up a new tip using the supplied tweezers. Identify the correct end to insert into the probe tip arm as shown in **Figure 41**. The end of the tip that has the wider diameter is inserted into the tip arm.
- 4 Using the tweezers, align the new tip with the browser's tip socket and gently insert the tip while avoiding any twisting motion.

**CAUTION**

The probe tip arm can be damaged if too much force is applied when inserting the tip. The tip is held in the tip arm by friction and *not* by a snap or detent connection.

---



**Figure 41** Inserting a Tip

- 5 Hold the probe vertically and gently press the tip on a hard surface, such as the tweezers, to properly seat the tip.

## 9 MX0105A InfiniiMax Differential SMA Probe Head



Overview	94
MX0105A Probe Head Components	94
MX0105A Dimensions	96
MX0105A SPICE Subcircuit Data	97
MX0105A Input Return Loss (S11)	98

## Overview



The MX0105A SMA probe head allows an easy and a high bandwidth (21 GHz) connection using SMA cables.

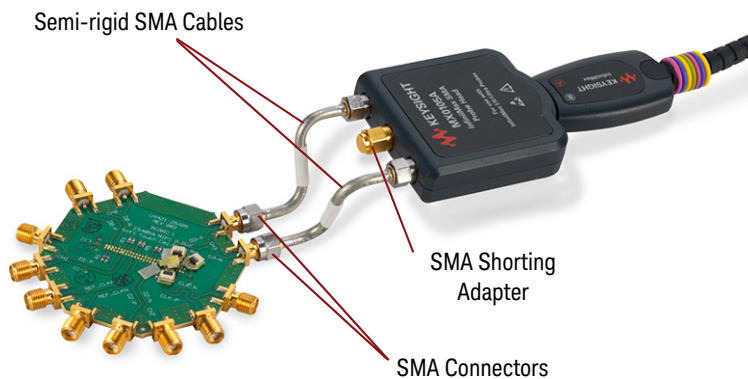
Unlike coaxial cables that require two oscilloscope channels to measure a differential signal, this probe head requires a single oscilloscope channel to measure a differential signal. This allows you to acquire four signals simultaneously on an oscilloscope using these probe heads. This can be specially useful in situations such as viewing two lanes simultaneously with each lane having a differential pair.

The probe head’s cable loss is compensated.

The termination network on the probe head can accommodate different standards or needs including supplying a common DC voltage to the termination point.

See [page 43](#) for characteristics and specifications of MX0105A probe head and MX0023A probe amplifier.

### MX0105A Probe Head Components



**Figure 42** MX0105A probe head connected to DUT and MX0023A probe amplifier

**Table 17** MX0105A Probe Head Components

Component	Description / Usage
SMA Connectors	The two SMA connectors labeled in the picture above are for input signal connection. The input resistance is 50Ω on both these inputs to avoid probe loading effects.
Semi-rigid SMA Cables	These cables are formed in an offset configuration allowing you to use these in variable spacing between connection points. These cables can be spread out to a maximum of 91.7 mm.

**Table 17** MX0105A Probe Head Components

Component	Description / Usage
SMA Shorting Adapter	<p>The SMA shorting adapter connects one side of resistances on both SMA inputs to ground.</p> <p>For signaling standards such as HDMI and MIPI MPhy that require the resistances to be referenced to a common DC voltage rather than a ground, you can remove this shorting adapter and apply a common dc termination voltage (<math>\pm 4</math> V) using the supplied cable and a DC power supply. You can also control the termination voltage internally through the oscilloscope.</p>

### Extending the MX0105A Probe Head's Cable Length

You can extend the cable length of the MX0105A SMA probe head and add flexibility and convenience to the probing setup by using the N5448B (25cm) / N2823A (1m) phase matched cable pair. You can easily replace the supplied semi-rigid SMA cables of the MX0105A probe head with these cables. These cables support 2.92 mm male-to-2.92 mm male connection. For detailed specifications of these cables, refer to the user's guide available in the Document Library tab of [www.keysight.com/find/N5448B](http://www.keysight.com/find/N5448B).

MX0105A Dimensions

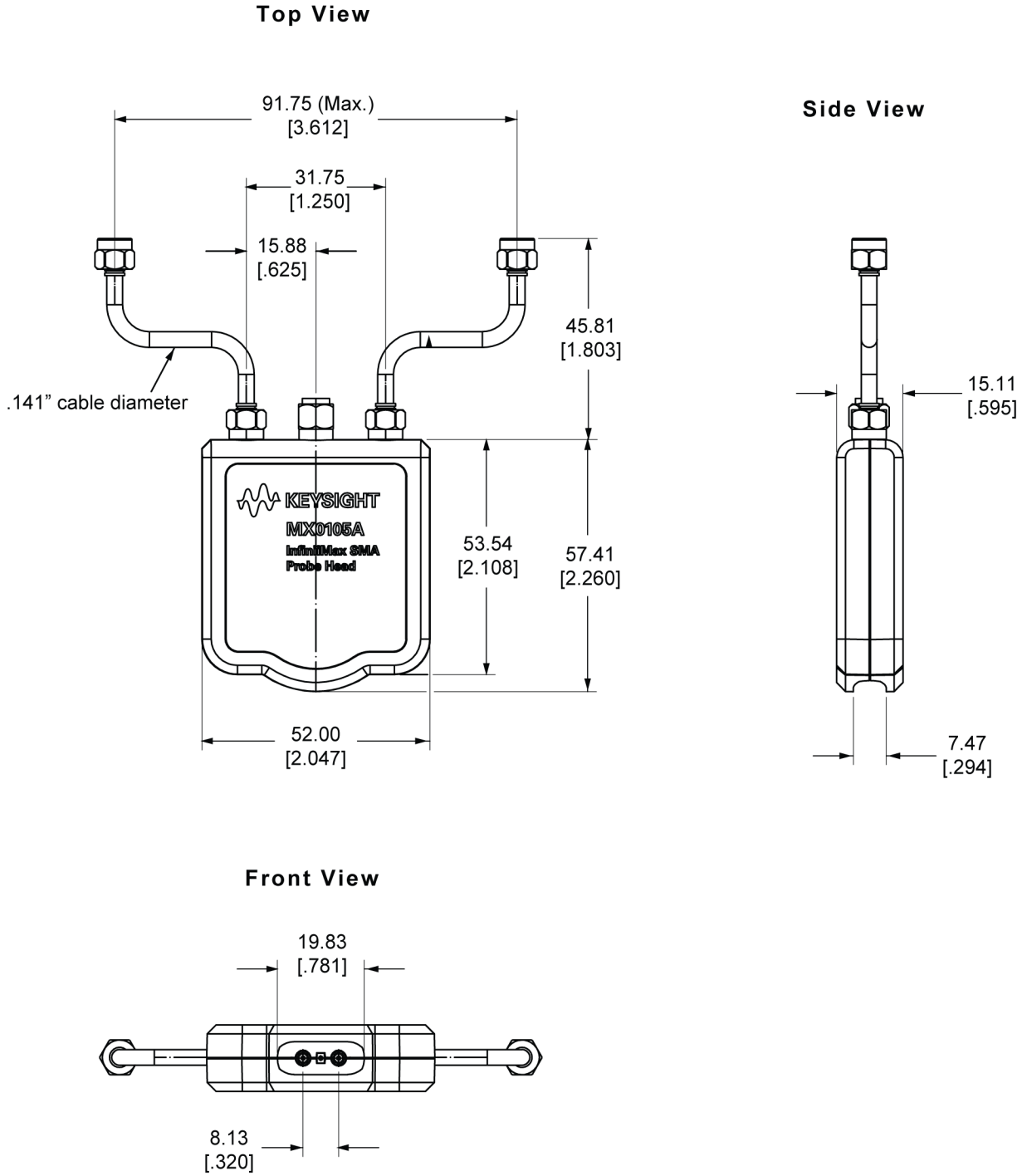


Figure 43 MX0105A Dimensions (All dimensions are in mm[inches])



## MX0105A SPICE Subcircuit Data

The MX0105A SMA probe head is modeled by 20 short transmission lines of varying impedance. This accurately models the temporal nature of this probe head.

```
* Input SPICE subckt model for MX0105A
.subckt MX0105A 1
t1 1 0 2 0 z0=51.9793 td=15ps
t2 2 0 3 0 z0=50.5258 td=15ps
t3 3 0 4 0 z0=51.7447 td=15ps
t4 4 0 5 0 z0=49.5073 td=15ps
t5 5 0 6 0 z0=44.7855 td=15ps
t6 6 0 7 0 z0=46.0311 td=15ps
t7 7 0 8 0 z0=48.87493 td=15ps
t8 8 0 9 0 z0=49.2082 td=15ps
t9 9 0 10 0 z0=51.4949 td=15ps
t10 10 0 11 0 z0=43.2229 td=15ps
t11 11 0 12 0 z0=57.0652 td=15ps
t12 12 0 13 0 z0=43.3563 td=15ps
t13 13 0 14 0 z0=49.3239 td=15ps
t14 14 0 15 0 z0=51.3944 td=15ps
t15 15 0 16 0 z0=44.1758 td=15ps
t16 16 0 17 0 z0=54.6484 td=15ps
t17 17 0 18 0 z0=53.9111 td=15ps
t18 18 0 19 0 z0=50.7807 td=15ps
t19 19 0 20 0 z0=49.9954 td=15ps
t20 20 0 21 0 z0=49.5464 td=15ps
r1 21 0 50
.end
```

### NOTE

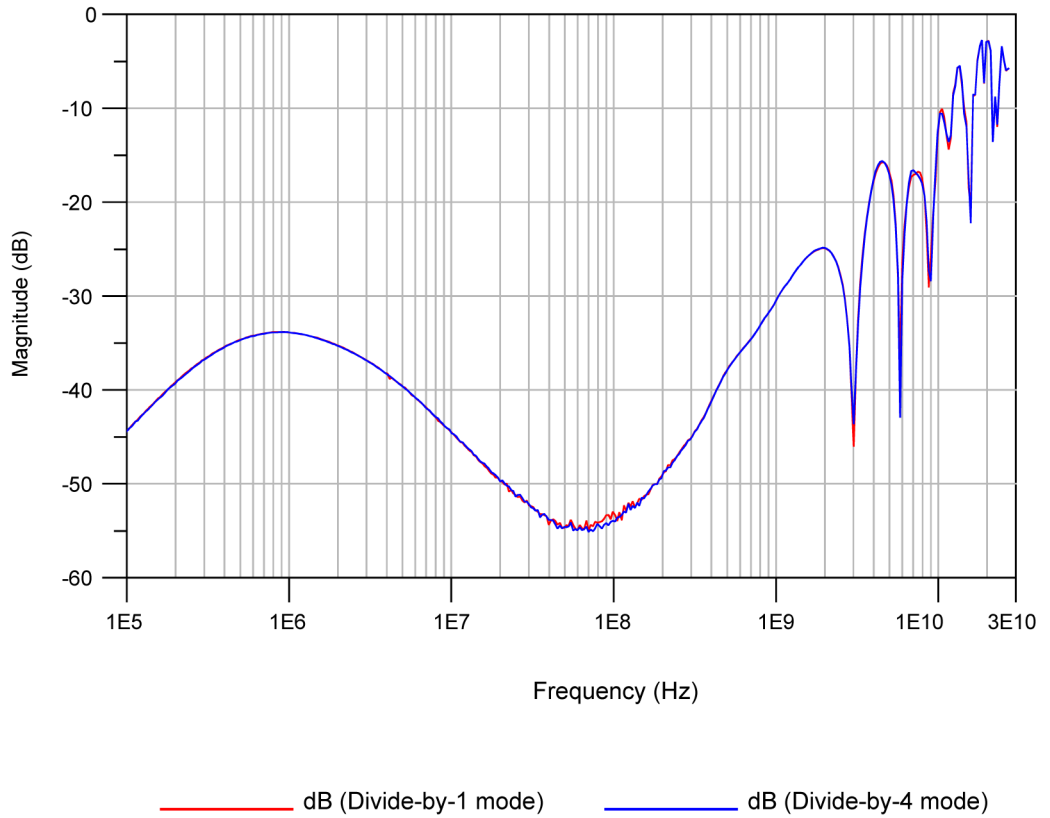
Refer to the chapter **"InfiniiMax RC Probe Amplifier and Probe Heads System Responses"** on page 143 to get a typical corrected frequency response and CMRR for the MX0023A probe amplifier and MX0105A probe head combination.

---

### MX0105A Input Return Loss (S11)

**NOTE**

Input return loss is a function of the probe head only. The probe amplifier being used does not affect the return loss for the probe head. The graph displayed below therefore does not include the probe amplifier being used.



**Figure 44** MX0105A Input Return Loss (S11)

# 10 N5425B InfiniiMax Differential ZIF Probe Head



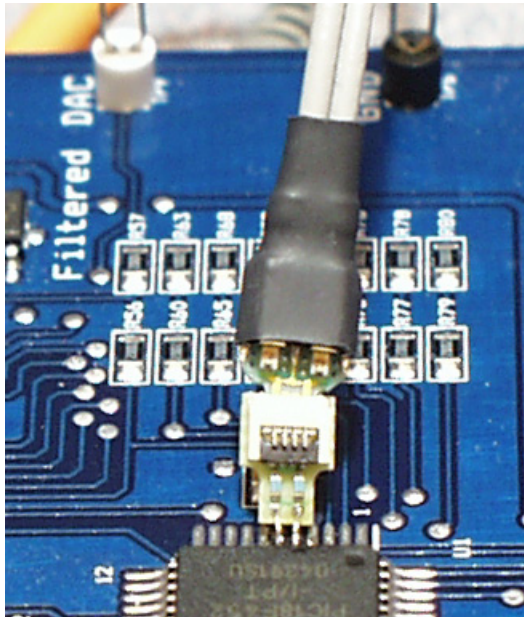
Overview	100
Supported ZIF Tips	100
N5425B Probe Head and ZIF Tips Dimensions	102
N5425B Input Impedance	104
Using the N5425B Probe Head with N5426A ZIF Tips	111
Step 1 - Remove N5426A ZIF Tip from Packaging	111
Step 2 - Attach the N5426A ZIF Tip to the N5425B Probe Head	111
Step 3 - Solder the N5426A ZIF Tip to the DUT	112
Using the N5425B Probe Head with N2884A Fine Wire ZIF Tip	116
Step 1 - Calibrate the Probe	116
Step 2 - Place the N5425B ZIF Probe Head into the Positioner Arm	116
Step 3 - Install the Positioner Arm Into the Micropositioner	117
Step 4.- Secure the Micropositioner	117
Step 5 - Attach the Probe Head to Probe Amplifier	118
Step 6 - Remove a Fine Wire ZIF tip From the Case	118
Step 7 - Attach the ZIF Probe Head to the Fine Wire ZIF tip	118
Step 8. Attach the Fine Wire ZIF tip Onto the Board	119
Maintaining the N5425B Probe Head	123
Fine Wire ZIF Tips Handling Precautions	123

## Overview



The N5425B Zero Insertion Force (ZIF) probe head is the best choice for probing multiple test points in a tight space. The three different types of ZIF tips available for use with this probe head accommodate very small fine pitch targets as well as variable pitch targets, including larger pitches.

When using this probe head, you can solder ZIF tips onto your DUT at multiple test points as needed. Because of the ZIF tip's extremely low loading, the tips can remain on the DUT as you easily move the probe head from one probing site to the next.



**Figure 45** N5425B Probe Head Attached to a ZIF Tip Soldered to DUT

See [page 43](#) for characteristics and specifications of N5425B probe head and MX0023A probe amplifier.

Based on the type of ZIF tip used with this probe head, the bandwidth that the probe head supports with the MX0023A probe amplifier varies. [Table 18](#) lists the bandwidth available for the ZIF tip/N5425B probe head/MX0023A probe amplifier combination.

### Supported ZIF Tips

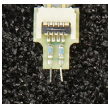

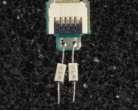
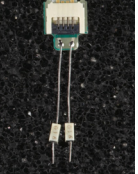
The N5425B probe head does not come with any ZIF probe tips. You need to separately order the supported ZIF tips matching your specific probing requirements.

The N5425B probe head supports the following three types of economical replaceable ZIF tips available as orderable kits.

**NOTE**

The N5426A and N2884A ZIF tips that support high bandwidth (18 GHz) are described in this user's guide. For details on the N5451A ZIF tip, refer to the 1168/9B-Series Probes user's guide.

**Table 18** N5425B ZIF Tips

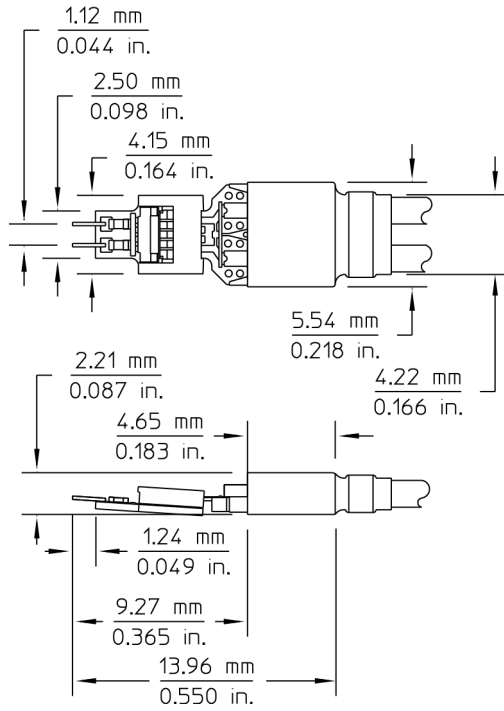
ZIF Tip	Description	ZIF Tip Kit Contents	Bandwidth Supported <sup>a</sup>
<b>N5426A</b> 	<b>Standard ZIF Tip</b> <ul style="list-style-type: none"> <li>Solderable ZIF tip for small fine pitch targets</li> </ul>	<ul style="list-style-type: none"> <li>10 ZIF tips</li> </ul>	18 GHz
<b>N2884A</b> 	<b>Fine Wire ZIF Tip</b> <ul style="list-style-type: none"> <li>Non solderable ZIF tip for wafer-probing an active IC</li> <li>Equipped with 22 micron tungsten wires. As wires are extremely small and difficult to see, use a high-powered microscope when working with these tips.</li> </ul>	<ul style="list-style-type: none"> <li>5 fine wire ZIF tips</li> <li>1 positioner arm with thumb nut (to mount the probe head to a micropositioner)</li> </ul>	18 GHz
<b>N5451A</b>  	<b>Long Wire ZIF Tip (trimmed to 7mm or 11mm)</b> <ul style="list-style-type: none"> <li>Solderable ZIF tip with resistor<sup>b</sup> length that can be trimmed to 7mm or 11mm for longer reach.</li> <li>Suitable for variable pitch targets</li> </ul>	<ul style="list-style-type: none"> <li>10 ZIF tips</li> <li>Trim Gauge (N5451A-94301) to properly trim and shape the resistor leads of tips</li> </ul>	<b>For 7mm resistor leads<sup>c</sup></b> <ul style="list-style-type: none"> <li>~9.9 GHz with 0° span</li> <li>~4.4 GHz. with 60° span</li> </ul> <b>For 11mm resistor leads<sup>c</sup></b> <ul style="list-style-type: none"> <li>~5 GHz with 0° span</li> <li>~3.3 GHz. with 60° span</li> </ul>

a Bandwidth applicable for the specific ZIF tip + N5425B probe head + MX0023A probe amplifier combination

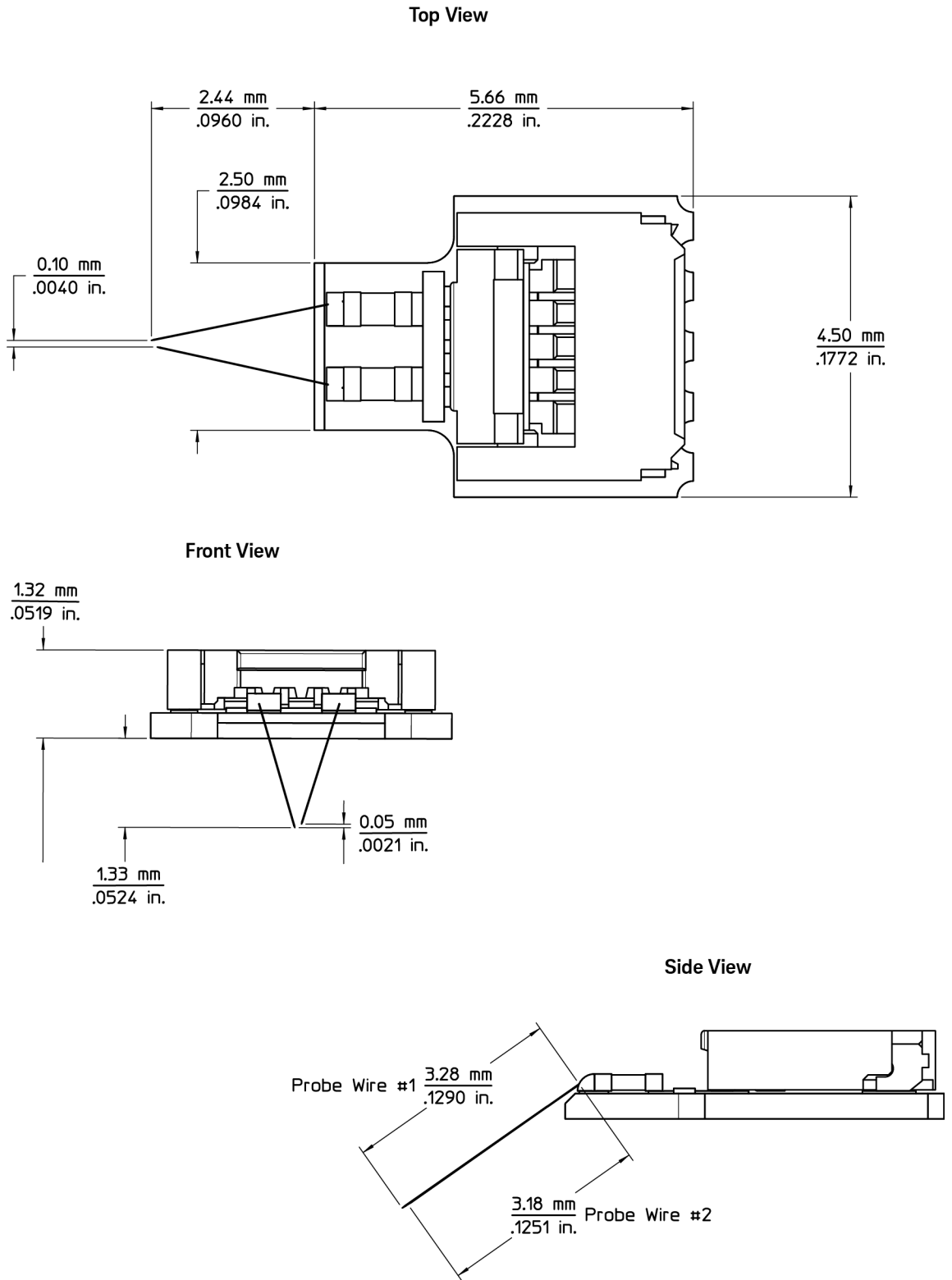
b For additional long wire ZIF resistor leads, order 1NC3-1091 (qty 1).

c The available bandwidth decreases as the span between the long wire tip leads increases.

### N5425B Probe Head and ZIF Tips Dimensions



**Figure 46** N5425B ZIF Probe Head Dimensions with N5426A ZIF Tip Attached



**Figure 47** N2884A Fine Wire ZIF Tip Dimensions

## N5425B Input Impedance

**NOTE**

Input impedance is a function of the probe head only. The probe amplifier bandwidth (25 GHz) does not have any effect on the input impedance of the probe head.

---

This section provides:

- the SPICE model for N5425B probe head with N5426A and N2884A ZIF tips attached. This SPICE model is only for input impedance which allows modeling of the probe loading effects. Probe transfer function is generally flat to the specified bandwidth.
- input impedance plots for N5425B probe head with N5426A and N2884A ZIF tips attached. to show the matching of the measured data to the modeled data. Matching is generally very good up to the specified bandwidth of the probe head.

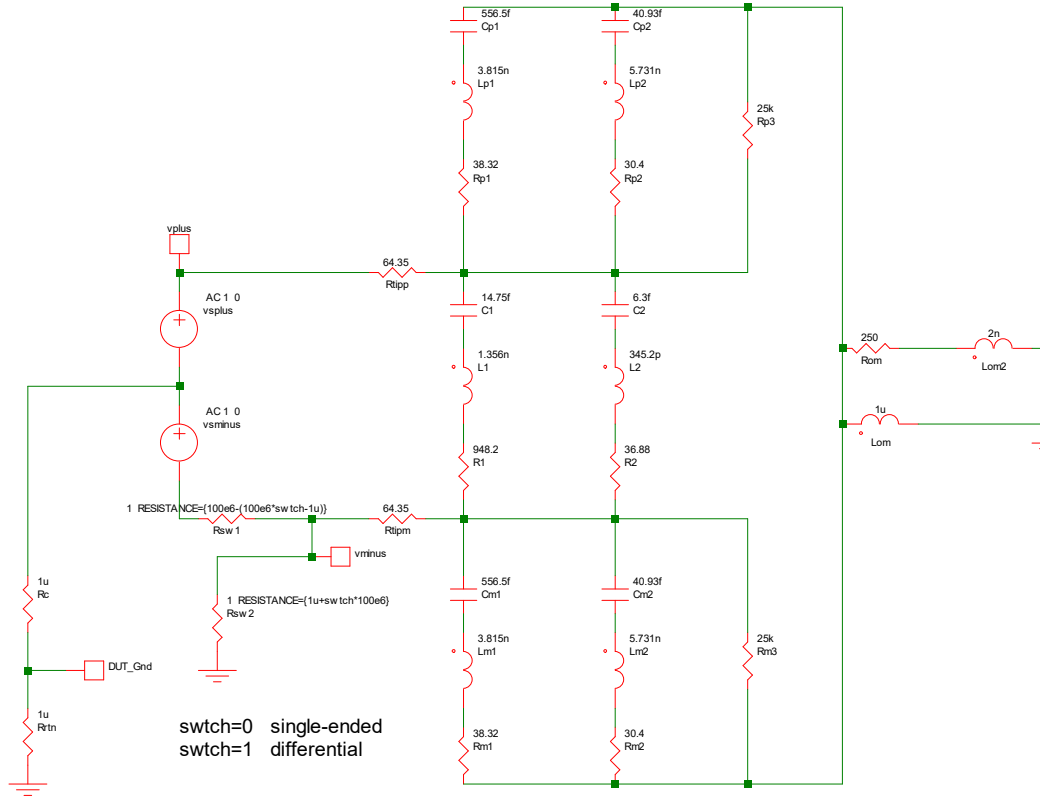
**NOTE**

Refer to the chapter **"InfiniiMax RC Probe Amplifier and Probe Heads System Responses"** on page 143 to get a typical corrected frequency response and CMRR for the MX0023A probe amplifier and probe head combination.

---



SPICE Model of N5425B Probe Head with N5426A ZIF Tip Attached



**Figure 48** SPICE Model for N5425B with N5426A ZIF Tip

When using differential probe to probe single-ended signals:

- vplus connected to DUT signal
- vminus connected to DUT ground which means that  $R_{sw1} = \infty$  and  $R_{sw2} = 0$
- Input impedance is defined to be  $v_{plus}/i(v_{plus})$

When using differential probe to probe differential signals:

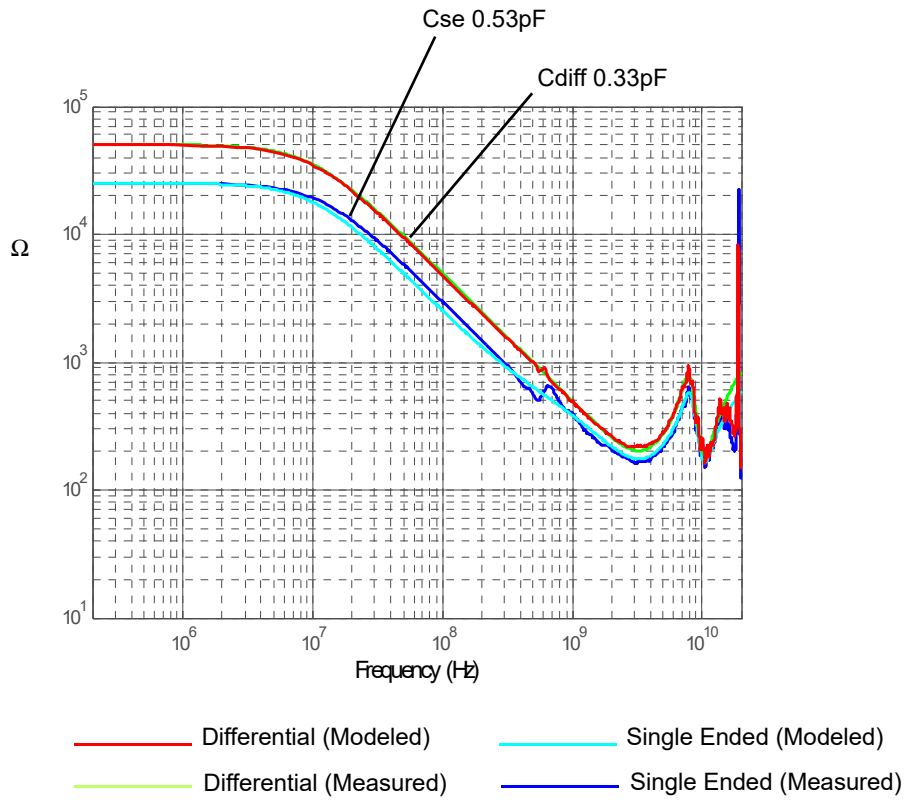
- $R_c$  (or  $Z_c$ ) will depend on the DUT circuit.
- vplus connected to DUT plus signal
- vminus connected to DUT minus signal.
- Input impedance is defined to be  $(v_{plus} - v_{minus})/i(v_{plus})$

## SPICE Deck of N5425B Probe Head with N5426A ZIF Tip Attached

```

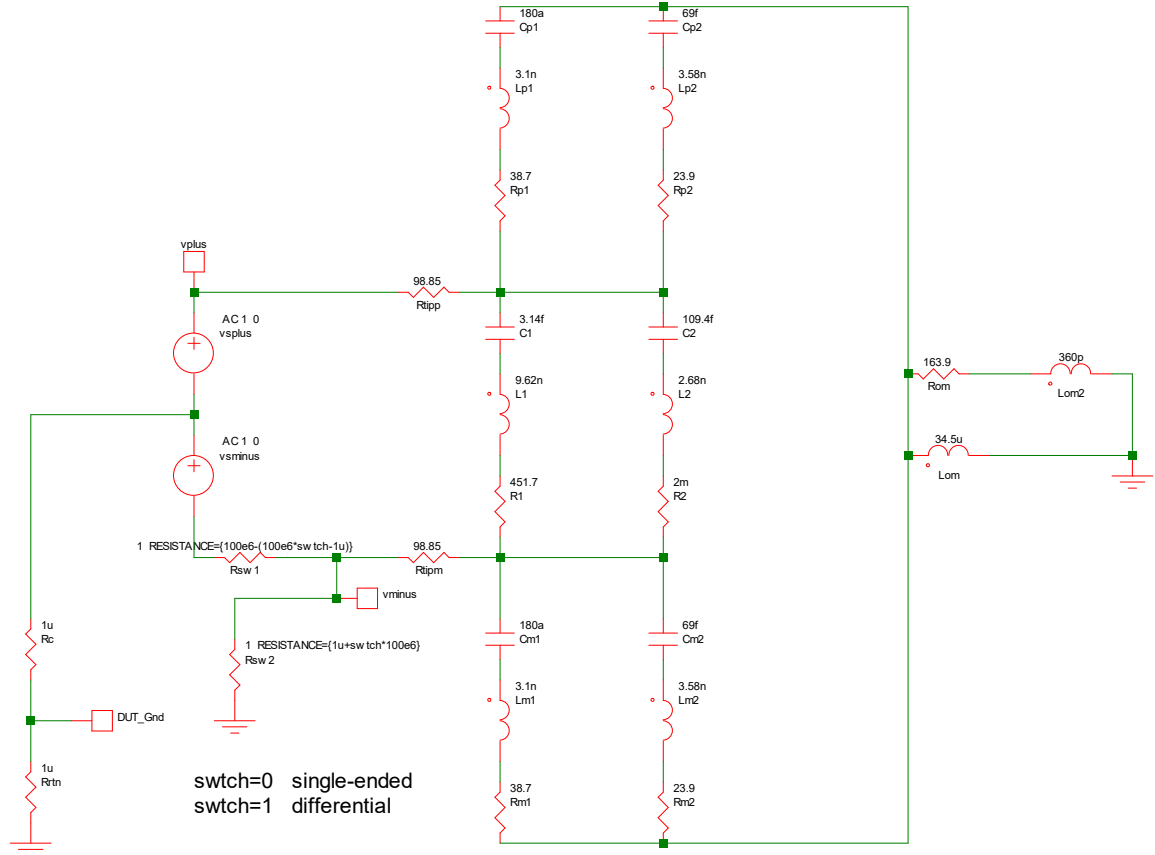
Lom2 Rom_P 0 2n
Lm2 Cm2_N Lm2_N 5.731n
Rtipp Rp3_N vplus 64.35
Lm1 Cm1_N Lm1_N 3.815n
Rom Rom_P Cp1_P 250
Cp1 Cp1_P Cp1_N 556.5f
Cp2 Cp1_P Cp2_N 40.93f
Lp1 Cp1_N Lp1_N 3.815n
Lp2 Cp2_N Lp2_N 5.731n
Cm2 R1_N Cm2_N 40.93f
vsminus vsplus_N vsminus_N AC 1 0
L1 C1_N L1_N 1.356n
L2 C2_N L2_N 345.2p
Rp1 Lp1_N Rp3_N 38.32
Cm1 R1_N Cm1_N 556.5f
Rp2 Lp2_N Rp3_N 30.4
Rp3 Cp1_P Rp3_N 25k
Rrtn DUT_Gnd 0 1u
Rsw2 vminus 0 1 1u+swtch*100e6
vsplus vplus vsplus_N AC 1 0
Rm2 Lm2_N Cp1_P 30.4
Rm3 R1_N Cp1_P 25k
Rsw1 vminus vsminus_N 100e6-(100e6*swtch-1u)
Lom Cp1_P 0 1u
C2 Rp3_N C2_N 6.3f
Rm1 Lm1_N Cp1_P 38.32
Rc vsplus_N DUT_Gnd 1u
C1 Rp3_N C1_N 14.75f
Rtipm R1_N vminus 64.35
R1 L1_N R1_N 948.2
R2 L2_N R1_N 36.88
.AC DEC 200 200k 20G SWEEP PARAM=swtch LIN 2 0 1
.PARAM swtch=1

```



**Figure 49** Measured and Modeled Data Matching for the N5425B Probe Head with N5426A ZIF Tip Attached

### SPICE Model of the N5426A ZIF Tip



**Figure 50** SPICE Model for N5426A ZIF Tip

**NOTE**

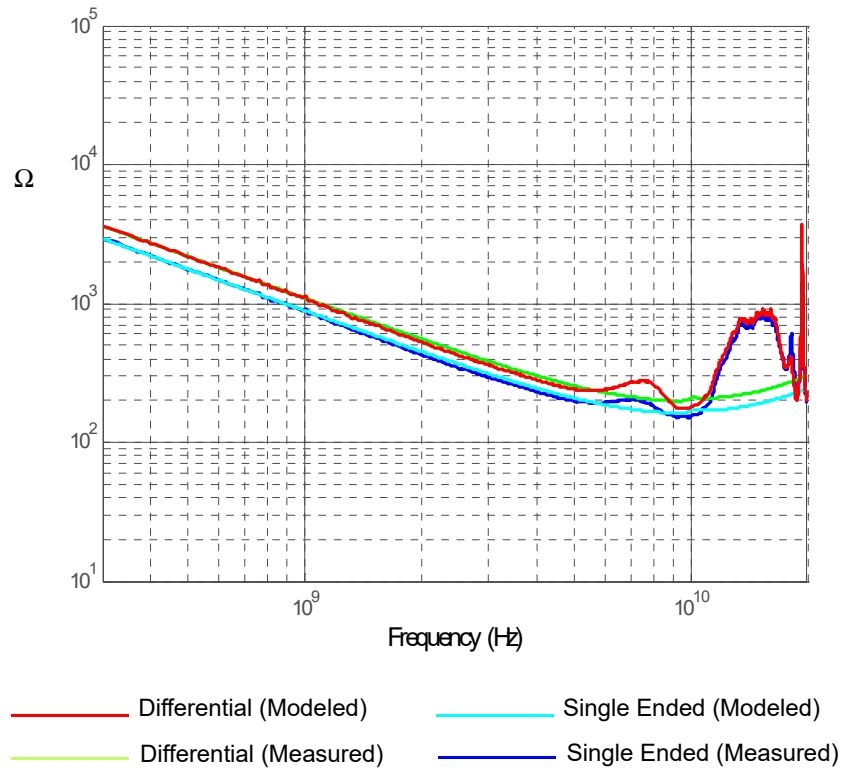
Use this SPICE model to model the input loading for the N2884A fine wire ZIF tip as well.

## SPICE Deck of N5426A ZIF Tip

```

Lm2 Rom_P 0 360p
Lm2 Cm2_N Lm2_N 3.58n
Rtipp Rp3_N vplus 98.85
Lm1 Cm1_N Lm1_N 3.1n
Rom Rom_P Cp1_P 163.9
Cp1 Cp1_P Cp1_N 180a
Cp2 Cp1_P Cp2_N 69f
Lp1 Cp1_N Lp1_N 3.1n
Lp2 Cp2_N Lp2_N 3.58n
Cm2 R1_N Cm2_N 69f
vsminus vsplus_N vsminus_N AC 1 0
L1 C1_N L1_N 9.62n
L2 C2_N L2_N 2.68n
Rp1 Lp1_N Rp3_N 38.7
Cm1 R1_N Cm1_N 180a
Rp2 Lp2_N Rp3_N 23.9
Rrtn DUT_Gnd 0 1u
Rsw2 vminus 0 1 RESISTANCE={1u+swtch*100e6}
vsplus vplus vsplus_N AC 1 0
Rm2 Lm2_N Cp1_P 23.9
Rsw1 vminus vsminus_N 1 RESISTANCE={100e6-(100e6*swtch-1u)}
Lom Cp1_P 0 34.5u
C2 Rp3_N C2_N 109.4f
Rm1 Lm1_N Cp1_P 38.7
Rc vsplus_N DUT_Gnd 1u
C1 Rp3_N C1_N 3.14f
Rtipm R1_N vminus 98.85
R1 L1_N R1_N 451.7
R2 L2_N R1_N 2m
.AC DEC 200 200k 20G SWEEP PARAM=swtch LIN 2 0 1
.PARAM swtch 1

```

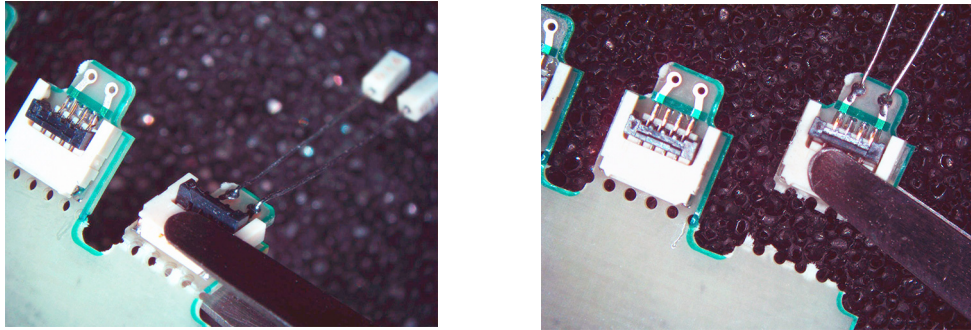


**Figure 51** Measured and Modeled Data Matching for the N5426A ZIF Tip

## Using the N5425B Probe Head with N5426A ZIF Tips

### Step 1 - Remove N5426A ZIF Tip from Packaging

Before a ZIF tip can be used, you must separate it from its packaging strip. To accomplish this, grab one of the tips with flat nose tweezers and bend it back. Then, bend the tip in the opposite direction and it should break off.



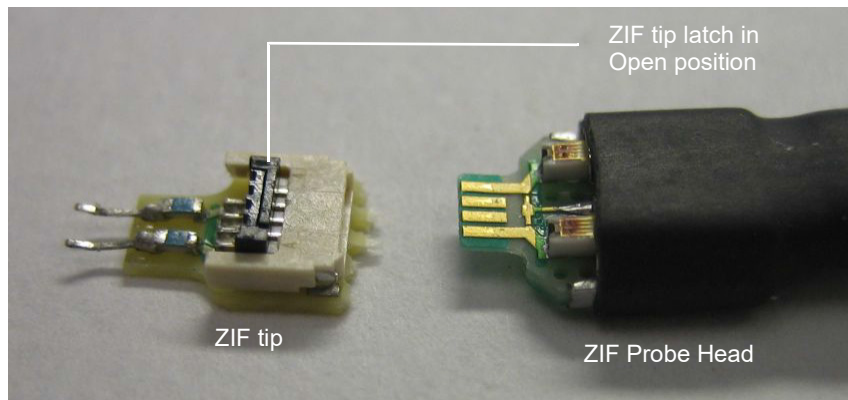
**Figure 52** Breaking Off a ZIF Tip from Packaging

#### CAUTION

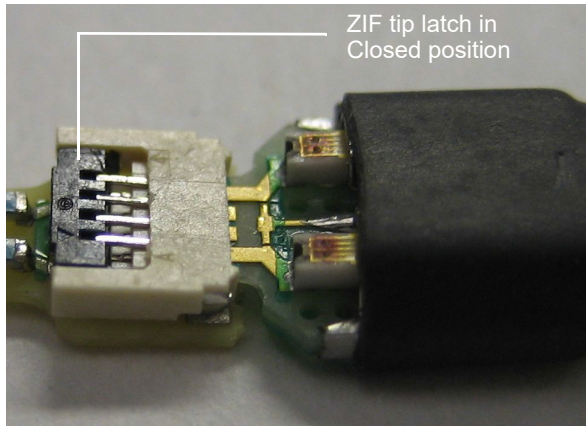
Do not grab the ZIF tip by its wires.

### Step 2 - Attach the N5426A ZIF Tip to the N5425B Probe Head

To attach the ZIF tip to the ZIF probe head, open (lift up) the tip's black latch, insert the probe head into the tip, and close the latch.



**Figure 53** ZIF Tip Latch in Open Position



**Figure 54** ZIF Tip Latch in Closed Position

If you are attaching the ZIF tip to the probe head when soldering the tip to DUT, you may need to support the body of the ZIF tip while closing its latch. Use tweezers or other suitable tool to grab the tip's pc board while the latch is being closed. If the circuit is live, use plastic or non-conductive tweezers.

### Step 3 - Solder the N5426A ZIF Tip to the DUT

Soldering a ZIF tip into a DUT is straightforward, but some of the traditional soldering techniques that are typically used on larger components will not work well here. The following is an overview of the recommended soldering techniques.

- 1 Add some solder to the DUT connection points. There should be enough solder to provide a good fillet around the ZIF tip's leads, but not so much as to create a big solder ball. A fine MetCal (or equivalent) soldering tip should be used along with some 11 or 15 mil solder.
- 2 Using a rosin flux pen, coat the solder points with flux. The flux core solder does not provide enough flux for this small scale soldering. Also, put flux on the tips of the leads of the ZIF tip.
- 3 Clean the soldering tip well, then add a little bit of solder to the tip. It may take several tries to get just a little bit of solder right at or near the tip of the soldering iron. The solder on the tip keeps the soldering iron tip from pulling solder off the DUT connection points. This step may be optional if there is already enough solder on the DUT connection points.
- 4 Position a lead of the ZIF tip on top of one of the target points, then briefly touch the soldering iron tip to the joint. The thermal mass of this joint is very small, so you don't need to dwell on the joint for very long. The flux that was added to the joint should produce a good, clean solder joint. If you do not get a good, shiny, strong solder joint, then there was either not enough flux or the joint was heated too long and the flux boiled off.
- 5 There is a possibility that if a lead of the ZIF tip is inserted into a large ball of solder that is heated excessively with a soldering iron, the solder joint holding the lead onto the ZIF tip pc board could flow and the lead would come off

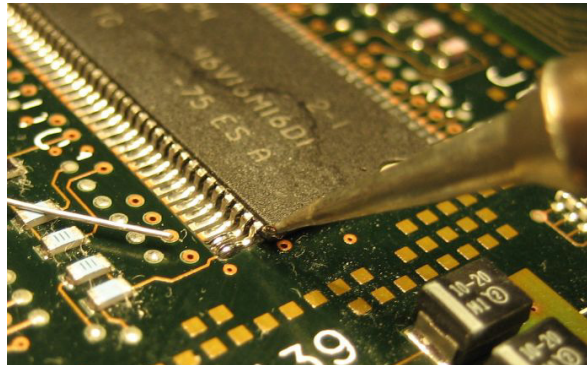


destroying the ZIF tip. Only the first third of the lead or so needs to be soldered to the target point.

### Detailed Soldering Procedure

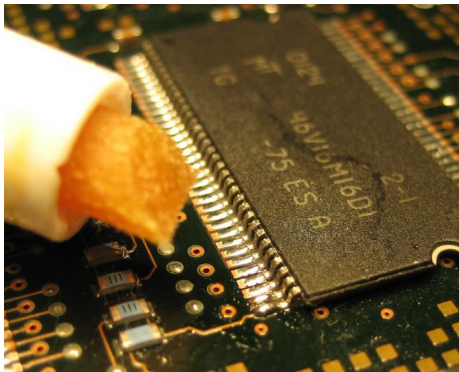
Below is an example of installing a ZIF tip to an IC package. The ZIF tip is attached to the first two package leads. The target could also be via pads or signal traces.

- 1 Add some solder to the target points in the DUT. The following figure shows extra solder added to the pads for the first two pins on an IC package.



**Figure 55** Solder Added to Target Points

- 2 Use flux pen to add flux to the target points. Also, flux the tip of the lead on the ZIF tip at this time.



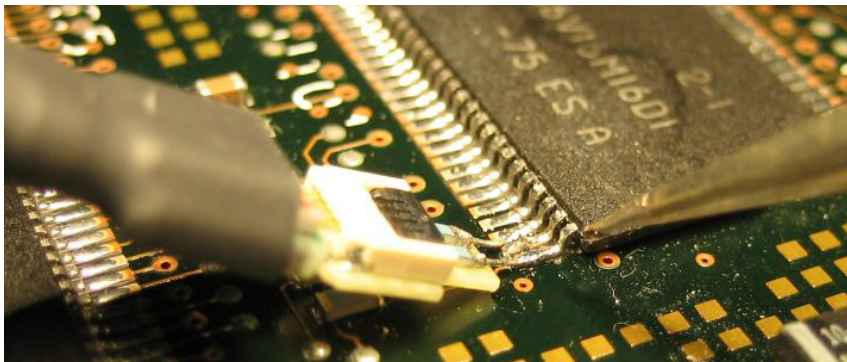
**Figure 56** Fluxing of the Target Points

- 3 Clean the soldering iron tip and add a small amount of solder to the very tip. This may take a few tries because the solder may tend to ball up and move away from the tip.



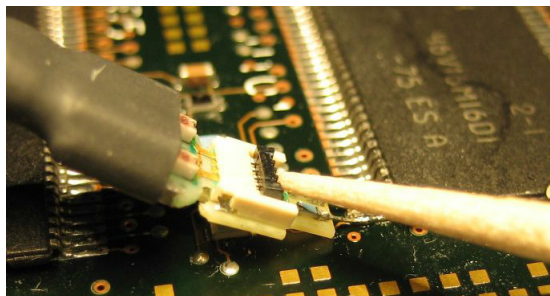
**Figure 57** Small Amount of Solder Added to Soldering Iron Tip

- 4 Connect the ZIF tip to the ZIF probe head. This allows the probe head to be used as a handle for the ZIF tip to allow positioning in the DUT. Position the lead wires on the target points and then briefly heat the solder joints. There should be enough solder to form a good fillet and enough flux to make the joint shiny. There shouldn't be so much solder that the big solder ball is formed that could cause a solder bridge or overheat the leads on the ZIF tip.

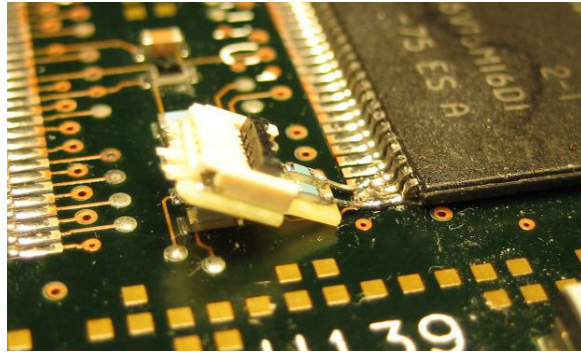


**Figure 58** ZIF tip Positioned and Soldered In Place

- 5 Open the ZIF tip latch, and remove ZIF probe head and leave ZIF tip behind for future connection. It is best to use a non-conductive, pointed object such as a toothpick or plastic tool. Hold on the heat-shrink part of the probe head to support the ZIF tip while releasing the latch.



**Figure 59** Using a Non-Conductive Tool to Open the ZIF Tip's Latch



**Figure 60** ZIF Tip with ZIF Latch Open

## Using the N5425B Probe Head with N2884A Fine Wire ZIF Tip

The procedure required to use the fine wire ZIF tips is very specific. Please read the instructions carefully as each step alerts you to common problem areas and things you need to be aware of when using this tip.

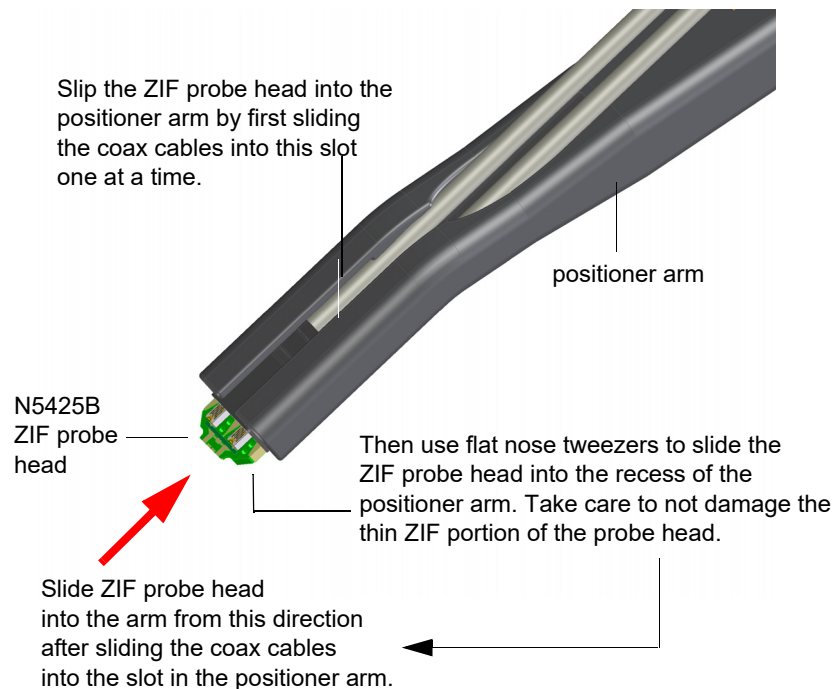
### Step 1 - Calibrate the Probe

If you have not recently calibrated the probe or if this is the first time you have ever used this probe amplifier/head/tip combination on the specific oscilloscope channel you plan on using, you should calibrate the probe. The best and easiest way to calibrate this probe setup is to use the standard N5425B + N5426A ZIF tips rather than the fine wire ZIF tips (since they are very similar in their electrical response characteristics and it is much easier to quickly work with the standard ZIF tip).

### Step 2 - Place the N5425B ZIF Probe Head into the Positioner Arm

Insert the N5425B ZIF probe head into the positioner arm as shown in the following figure. The fine wire ZIF tip should not be connected to the N5425B ZIF probe head yet.

**NOTE** The positioner arm is located inside the case with the fine wire ZIF tips.



**Figure 61** Probe Head and Tip in Positioner

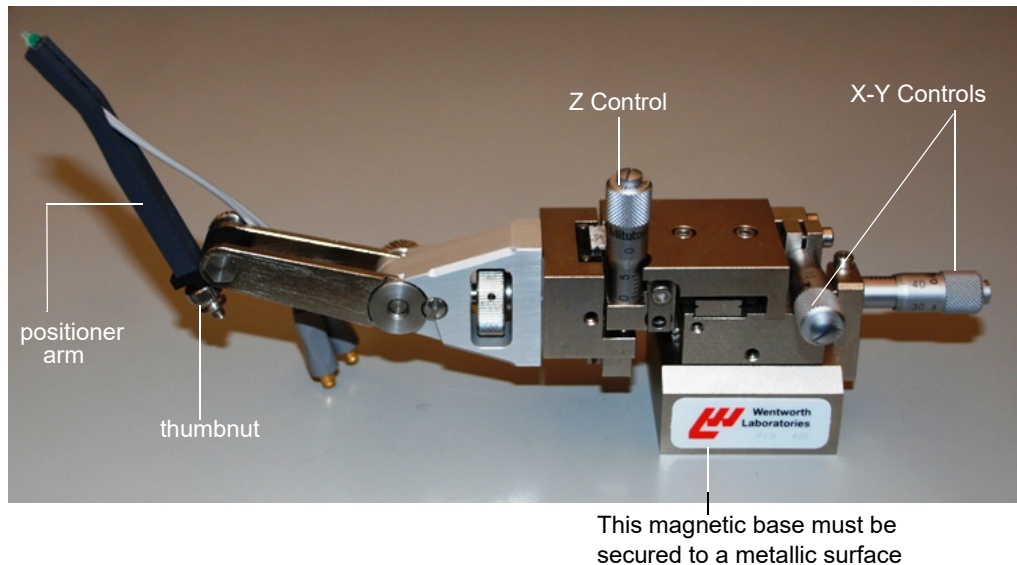
### Step 3 - Install the Positioner Arm Into the Micropositioner

Secure the positioner arm to a micropositioner using the thumb nut as shown in **Figure 62** on page 117. Keysight recommends using the Wentworth Laboratories micropositioner shown in the picture. You can either order it directly from Wentworth Laboratories ([www.wentworthlabs.com](http://www.wentworthlabs.com)) or you can order it from Keysight. If you order it through Keysight, you must order *both* of the following two parts:

- N2884-64702 (Wentworth 2026-90409 PVX 400-M: Manual Linear Manipulator Magnetic Base)
- N2884-64703 (Wentworth 5-00-4711 Short Nose Articulated Short Arm Front)

#### NOTE

While Keysight recommends using the Wentworth micropositioner, the Fine Wire ZIF positioner arm is compatible with many micropositioners as long as the thumb nut has enough threads to firmly secure the positioner arm.



**Figure 62** Micropositioner

### Step 4.- Secure the Micropositioner

#### CAUTION

Make sure the micropositioner is secured to something metallic (its base is magnetic) as it is nose-heavy. If it is left resting on a surface that the metallic base cannot secure to, it will tip over and the Fine Wire ZIF may become damaged.

### Step 5 - Attach the Probe Head to Probe Amplifier

Once the Fine Wire ZIF tip is attached to the probe head, it will be extremely important that you are careful with the entire setup (so you do not crush or damage the wires). Therefore, it is usually easiest to connect the probe head to the InfiniiMax probe amplifier before you attach the Fine Wire ZIF tips. You can also connect the probe amplifier to the oscilloscope at this time.

### Step 6 - Remove a Fine Wire ZIF tip From the Case

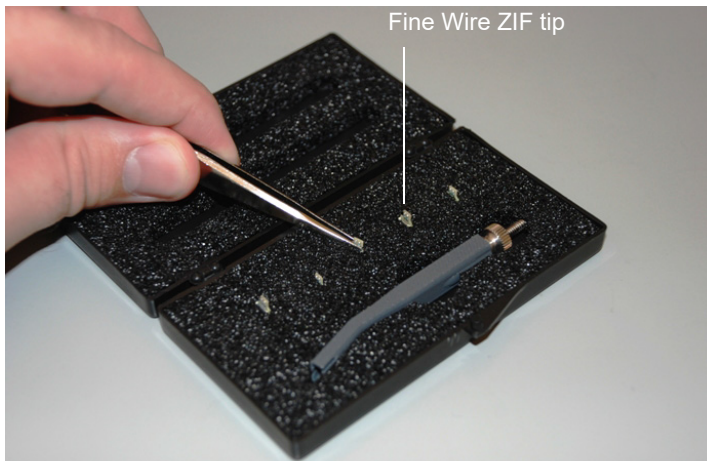
To remove a tip from the packaging, grasp the pc board of the tip with flat nose tweezers and lift directly out of the foam. See **Figure 63** on page 118.

**CAUTION**

Do not ever lift the tip out by grasping the wires.

**CAUTION**

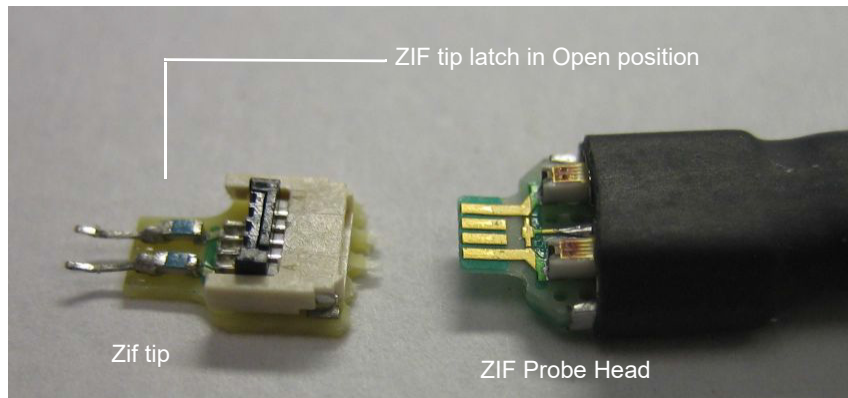
Each of the five Fine Wire ZIF tips has its wires pointing directly up in the kit case. There is a cutout in the case's lid that allows for these wires to not be bent when the lid is closed. If the wires are not pointed directly upward, these could become damaged when the lid is closed.



**Figure 63** Removing the ZIF Tip

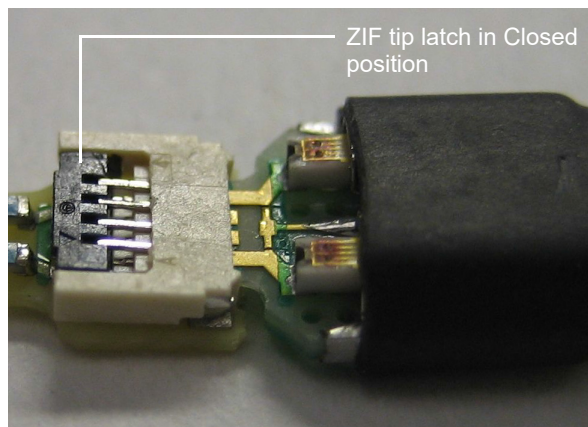
### Step 7 - Attach the ZIF Probe Head to the Fine Wire ZIF tip

While still grasping the tip with flat nose tweezers, use another set of tweezers to lift the latch to the open position as shown in **Figure 64** on page 119). Be careful to not hit the wires. The picture shows the standard ZIF tip and is only meant to highlight the latch's open position (the latch is the same on the standard and Fine Wire ZIF tips).



**Figure 64** ZIF Tip Latch in Open Position

The probe head should already be attached to the positioner arm (which is secured to the micropositioner). Push the Fine Wire ZIF tip onto the probe head and close the latch to lock them together. The picture below does not show the probe head inside the positioner arm. It is meant to show you what the latch looks like when it is closed.



**Figure 65** ZIF Tip Latch in Closed Position

## Step 8. Attach the Fine Wire ZIF tip Onto the Board

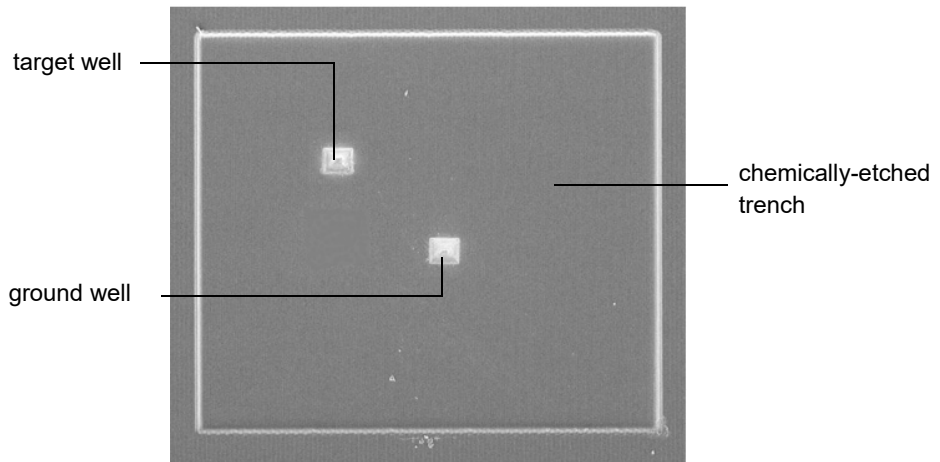
The procedure described below is for probing the underside of ICs and describes a specific use-scenario. There may be other possible ways to use this probe tip. The following steps require a probing station and a high-powered microscope.

### NOTE

**Do not turn on the DUT until you have landed both wires and confirmed that these wires are not touching (as described below).**

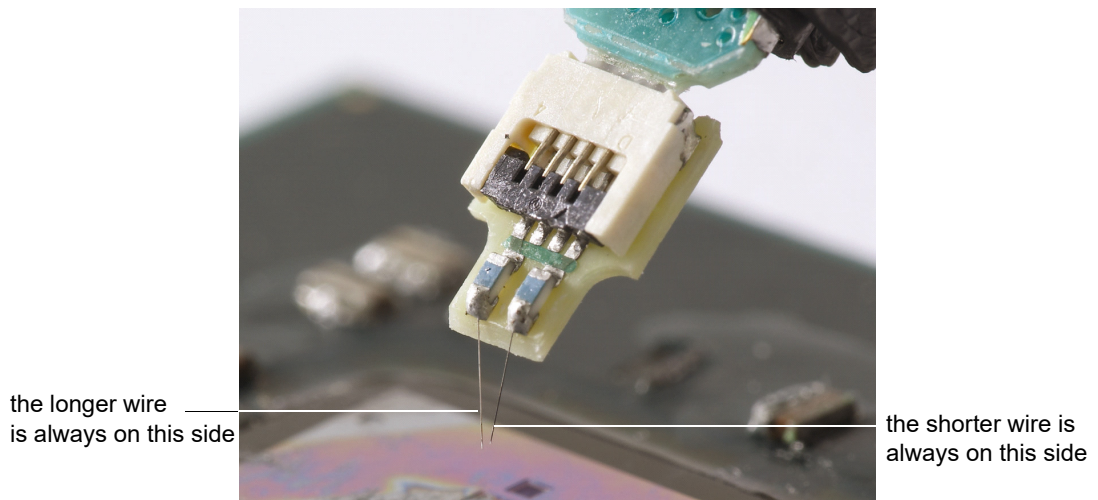
In order to prepare the IC for probing, you first need to chemically etch a large trench out of the IC. Within the trench, create at least two wells (target well and ground well) to the targeted metal layers. These wells should be approximately

15 x 15 microns and 10 microns deep. These wells keep the probe tip from slipping across the surface as they give a place for the wires to anchor. You may need to create many wells depending on the number of targets you want to probe, but you at least need two in order to have a ground well and a target well. A small amount of tungsten should be placed in the bottom of each well. The maximum distance between wells is 600 microns.



**Figure 66** Example of Trench and Two Wells Under Magnification

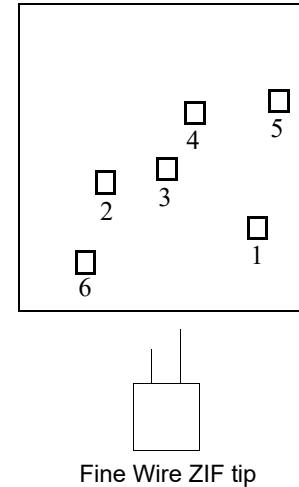
The two 22 micron wires on the Fine Wire ZIF tip are of different lengths. The longer wire will be driven down first to set the z-axis and then you will land the short wire. It does not matter which wire goes into the ground well and which goes into the target well, but it does matter that the longer wire is set first.



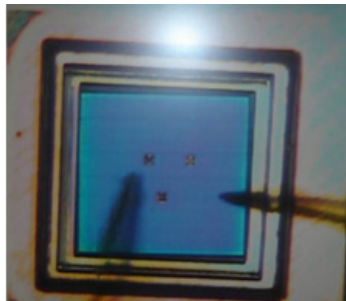
**Figure 67** ZIF Tip Wires



It also matters how the two wells are positioned relative to each other. When you land the longer wire first, you will want to land it in a well that is below and to the right (from the perspective of the probing direction) relative to the wells in which you are going to land the short wire. In the diagram above, you could land the longer wire in well 1 and then probe locations 2, 3, and 4 with the short wire. You could not, however, reach well 5 with the short wire (the two wires could cross, shorting them in the process). You also could not reach well 6 with the short wire due to the configurations of the wire (this will cause an upward bend in the wires that could be detrimental to the probing performance). The short wire wells will always need to be up and to the left of the long wire well (from the perspective of the probing direction).



To land both of the wires in the wells, first position the IC under a microscope and move both wires into the region as shown below.



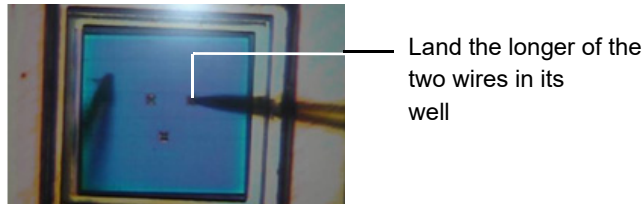
The two pointed shadows shown in the image to the left are the 22 micron wires

**Figure 68** Wires in Wells

How easy the rest of these steps are will depend on how powerful of a microscope you have. It may take a while to get adjusted to the process, but with some practice, you should grow in your comfort level.

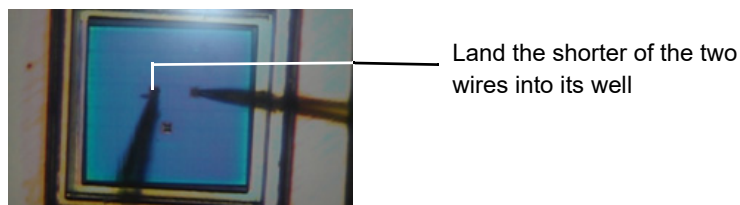
Move the positioner in the x-y direction until the tip of the long wire is above its well. You may not be able to see the wells and the wires in focus at the same time. If this is the case then first focus on the wells and then slowly move the focus out until you can see just the tips of the wires. You should then be able to move the longer wire tip over the first well.

Next, slowly land the tip in its well (using the z-direction adjustment on the micropositioner). Keep moving down until you see the end of the wire bend slightly. This will ensure that this wire remains stuck while we translate the shorter wire in the next step. Do not land the longer wire too hard or you could damage it. Once you see it flex, stop moving in the z-direction and use the x-y knobs on the micropositioner to wiggle the longer wire slightly. If the wire wiggles, but stays stuck in place on the IC then it was properly placed in the well.



**Figure 69** Longer Wire Landed

With the longer wire in place, move the micropositioner in the x-y direction until the shorter wire is over the target well. Then adjust the positioner in the z-direction to land the shorter wire into its well.



**Figure 70** Shorter Wire Landed

The Fine Wire ZIF tip should now be ready to make a differential measurement. Before turning on your DUT, you need to ensure that the two wires are not touching. You should be able to confirm in the microscope that the tips are not overlapping, but these wires do buckle when you land them so they could be touching further up the wires. Decrease the magnification of the microscope until you can see the entire length of both wires and ensure that the wires are not touching.

## Maintaining the N5425B Probe Head

### Fine Wire ZIF Tips Handling Precautions

**CAUTION**

When placing the Fine Wire ZIF tips back into the case, ensure that the tips are pointing directly up. The cutouts in the top of the case provide space for these wires when the case is closed. However, if the tips are not pointing directly up, they may miss these cutouts and become damaged.

---

Cutout in lid  
so tips do not get damaged  
when the case is closed

**CAUTION**

When the Fine Wire ZIF tip is positioned under a microscope, be very careful with the lenses of the microscope as you adjust the magnification or focus. If one of the lenses strikes the tip, it could permanently damage it.

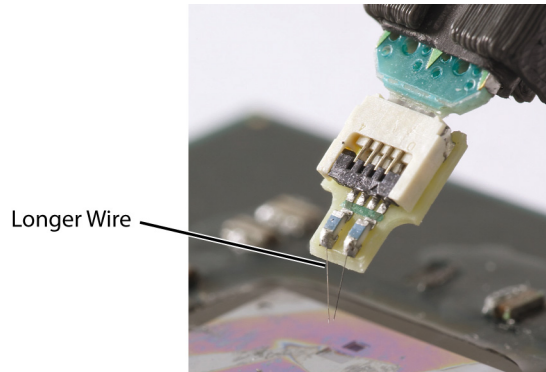
---

**CAUTION**

The two wires on the ZIF tip can come into contact during probing if you are not careful in preventing it. There are two ways this can happen.

(1) If you set the longer wire and then try to probe a position with the short wire that forces their tips to cross, the two wires can touch.

---



(2) When you set the wires, they will buckle. The wires may not be touching at their tips in this case (so they would look fine under a microscope), but the buckling could cause them to touch each other near their mid-points. Therefore, it is always a good idea to decrease the amount of magnification so you can see the entire wire lengths and make sure they are not in contact.

Turn on the device under test (DUT) only when you have verified that the wires are not touching.

---

# 11 Configuring Infiniium Software for Probe Amplifier and Probe Heads

Selecting Components Used in the Probing Setup	126
Configuring Offset Behavior	129
Calibrating your InfiniiMax RC Probe	131
Calibration Overview	131
Performing DC Gain / Offset and Skew Calibration	132

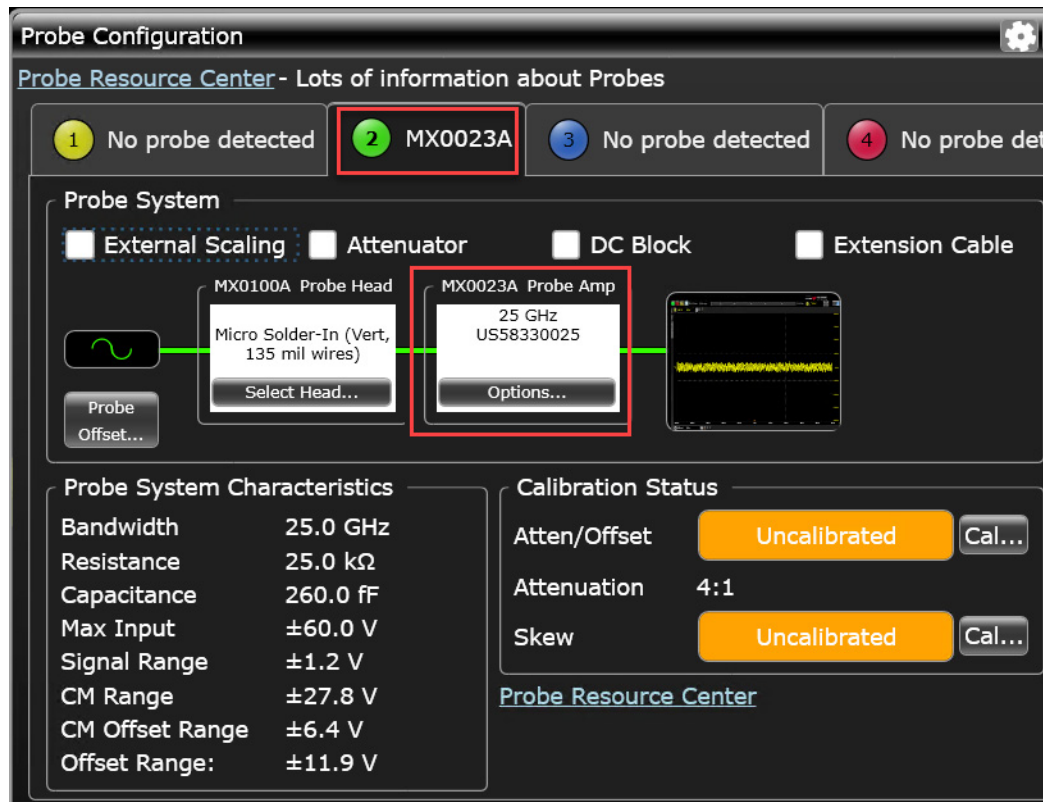
This chapter provides an overview of the steps you need to perform to configure your MX0023A probe amplifier and its probe head(s) using the oscilloscope's Infiniium software GUI. These probe configurations are required to get accurate measurement results.

## NOTE

For details on how to use the Infiniium software GUI, refer to the online help available with this GUI.

## Selecting Components Used in the Probing Setup

When you connect your MX0023A probe amplifier to a compatible Keysight oscilloscope, the amplifier is automatically detected and displayed as connected to the oscilloscope's channel in the Infiniium software GUI.



**Figure 71** MX0023A auto-detected in the Infiniium GUI on connection

Although the probe amplifier is auto-detected, the probe head or other components such as attenuators, DC blocking capacitors, or extension cables that you use in the probing setup are not automatically detected. To get accurate measurements, you need to ensure that all these components used in your probing setup are selected and displayed in the Probe Configuration dialog box.

### To select components used in the probing setup

- 1 Click **Setup** > **Probe Configuration...** to access the **Probe Configuration** dialog box.

The **Probe System** section displays the probe system block diagram and various components that you can select for addition to this probe system.

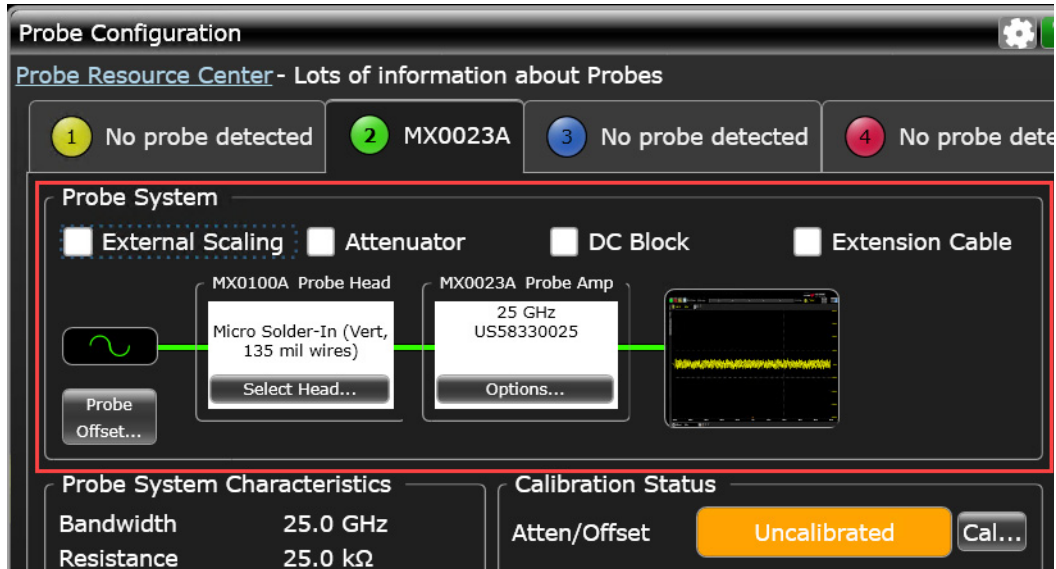


Figure 72 Probe connection diagram in the Probe System section

- 2 Select the checkbox displayed with the component(s) that you have used in the probing setup. The selected component(s) then get added to the probe connection diagram.

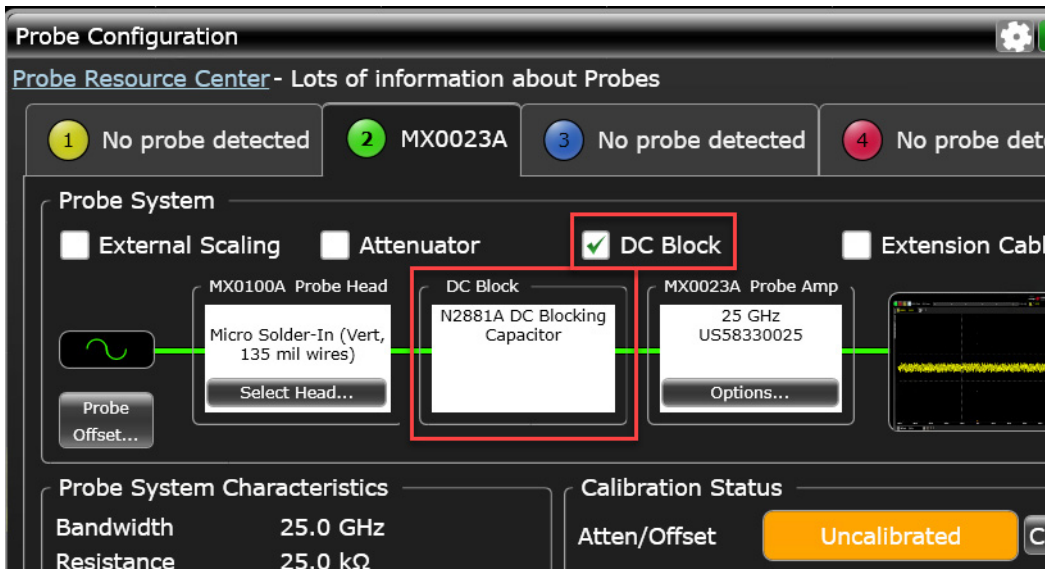
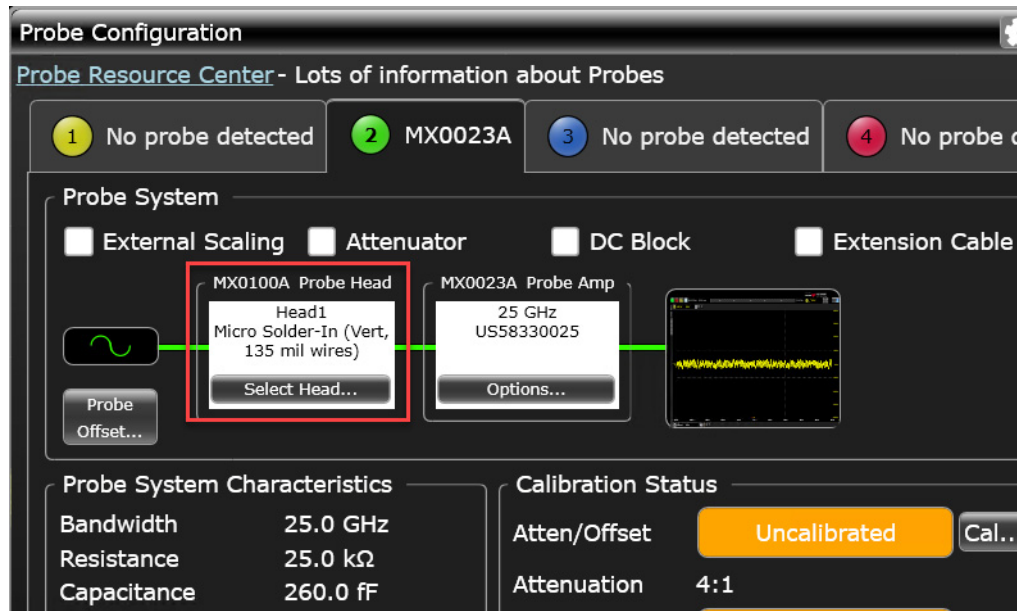


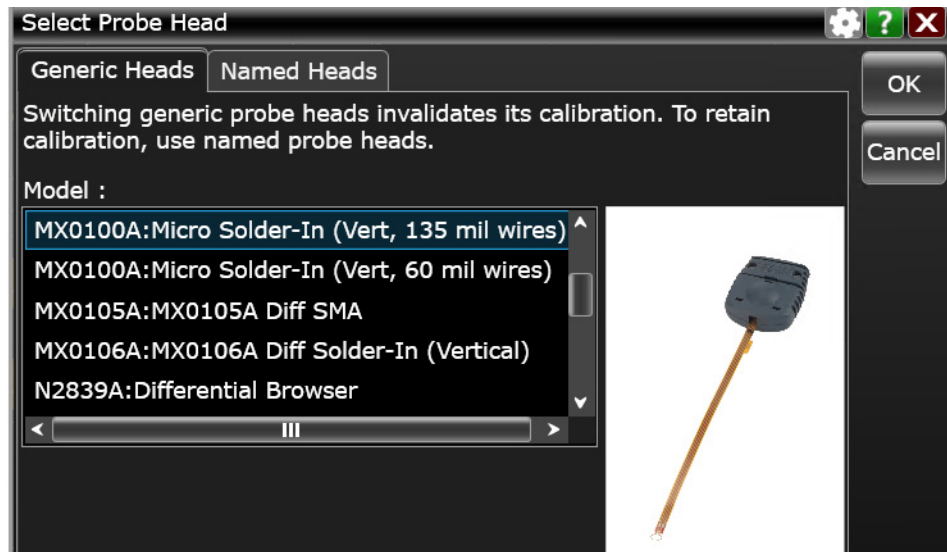
Figure 73 Example of DC blocking capacitors added to the probe system

Components added to the block diagram may have the **Options** button if additional configuration options are available for these components.

- 3 After selecting components, you can select the type of probe head(s) being used so that the oscilloscope can apply the appropriate correction filter (S parameter) for the probe head(s). Click **Select Head...** in the Probe Head block of the diagram.



The **Select Probe Head** dialog box is displayed in which you can select a generic or a named probe head. If you are planning to use more than one type of probe head with your amplifier, it is recommended to use Named heads as probe calibrations are preserved when you switch Named probe heads.

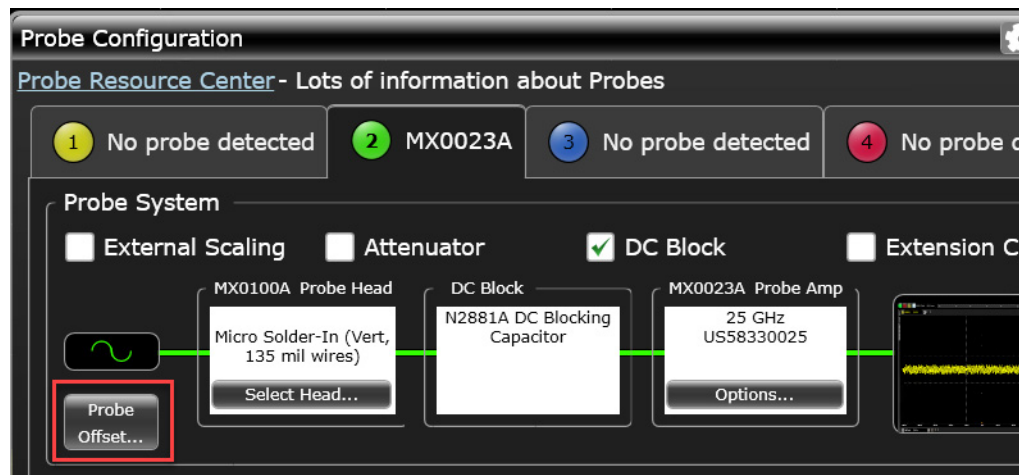




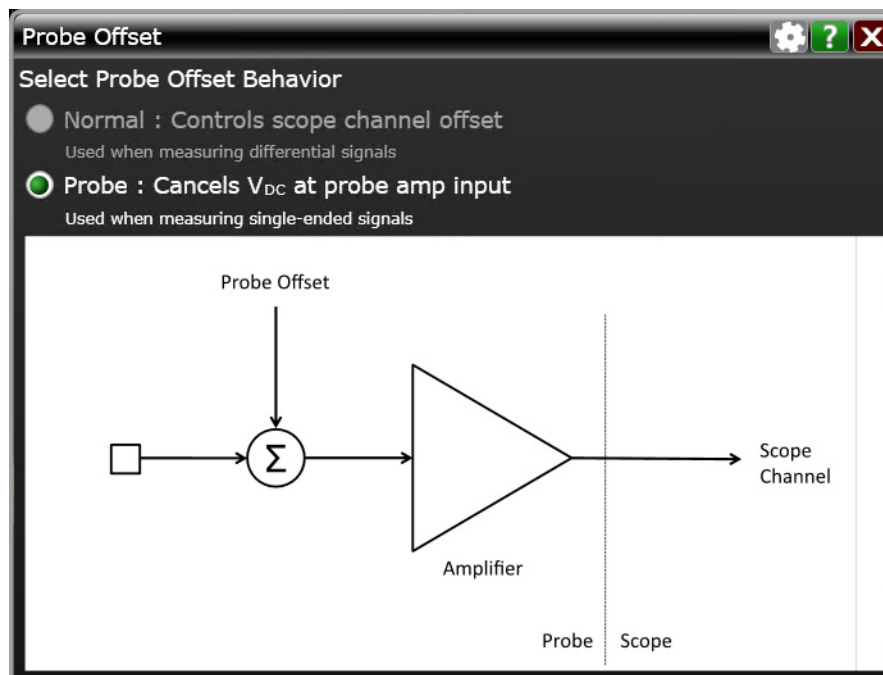
## Configuring Offset Behavior

You can configure the offset behavior to ensure that you get the maximum performance and dynamic range from your InfiniiMax RC probe. By applying an offset, most or all of the DC component can be subtracted and the signal can be positioned to better utilize the input's available dynamic range.

- 1 Click the **Probe / Normal Offset...** option displayed in the **Probe System** section.



- 2 In the **Probe Offset** dialog box, select the probe offset behavior.



In the Probe Offset dialog box, you can select the appropriate offset behavior matching your measurement scenario that is, based on the type of signal (single-ended or differential) being measured using a differential probe head.

You can choose to apply an offset by selecting either of the two options described in the table below.

**Table 19** Offset Behavior Options

Normal Offset	Probe Offset
Offset is applied at the oscilloscope channel. The vertical offset control on the oscilloscope's front-panel controls the channel's offset.	Offset is applied at the probe. The vertical offset control on the oscilloscope's front-panel controls the probe offset.
Used for measuring differential signals	Used for measuring single-ended signals
Probe offset is not used and set to zero.	Channel offset is not used and set to zero.
Provides an offset range (up to $\pm 2.5V$ ) for probing differential signals	Provides a very large offset range (up to $\pm 16V$ ) for probing single-ended signals and a large common-mode range for probing differential signals.
Allows the waveform seen on screen to be moved as desired. The allowable dc component in the plus and minus signals is determined by the common mode range of the probe.	Allows the offset voltage to be subtracted from the input signal before the signal gets to the probe amplifier. Since this subtraction is done before any active circuits, the offset range is large ( $\pm 16V$ ) allowing a differential probe to make higher bandwidth and more accurate measurements on single-ended signals.

**See Also**

- [Keysight application note 5988-9264EN](#)
- ["Probing Single-ended Signals using a Differential Probe Head"](#) on page 138

## Calibrating your InfiniiMax RC Probe

To get the highest measurement accuracy, you must calibrate your probe before you start using it.

### Calibration Overview

The following types of calibrations are available for the MX0023A probe amplifier.

**Table 20** Available Calibrations

	DC Gain/Offset Calibration	Skew Calibration	AC Response Calibration
Purpose	Adjustment of probe gain and probe offset. Removes any attenuation or offset errors caused by a probe.	Removes any timing delays caused by a probe.	Applies AC response correction to a probe so that its frequency response is flat up to its bandwidth.
When to perform	<ul style="list-style-type: none"> <li>▪ Calibrate your probe when using it for the first time on a channel input of the oscilloscope or when using it with a new probe head type.</li> <li>▪ Then, it is recommended to perform calibration regularly (several times a year).</li> <li>▪ Also, calibrate when the oscilloscope's calibration <math>\Delta</math> Temp is not within <math>\pm 5</math> °C.</li> </ul>		Automatically performed on connection (The oscilloscope automatically applies the appropriate correction filter for the probe amplifier and probe head to compute the overall probe correction.)

### Sequence of Calibration

- 1 DC Gain/Offset calibration
- 2 Skew calibration

### Before You Start Calibration

- Verify that the Infiniium oscilloscope has been calibrated. This information is available in the Infiniium Calibration dialog box (**Utilities > Calibration...**). If the oscilloscope has not been calibrated recently, calibrate the oscilloscope before calibrating the probe.
- Verify that the calibration  $\Delta$  temperature is within  $\pm 5$ °C. If this is not the case, calibrate the oscilloscope before calibrating the probe.
- Allow the probe to warm up for 15 minutes before starting the calibration procedure.
- Remove any attenuator attached to the probe. You cannot calibrate your probe with the attenuators attached.

## Performing DC Gain / Offset and Skew Calibration

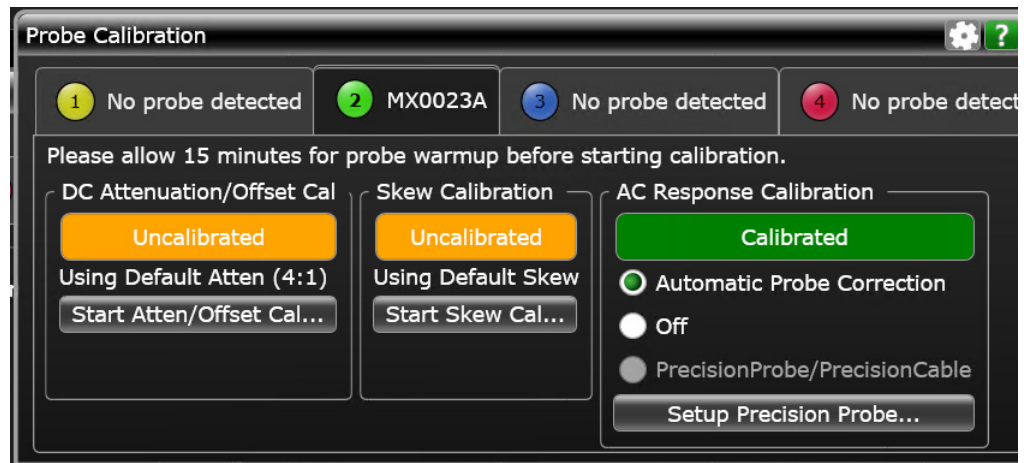
The probe calibration and deskew is a guided procedure that you initiate from the oscilloscope's **Probe Calibration** dialog box.

### Accessories Needed

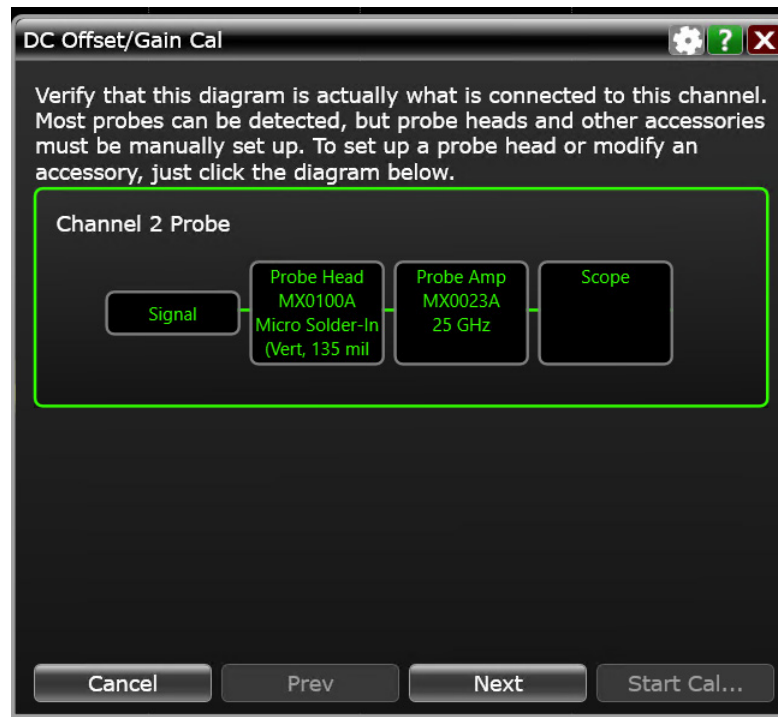
- MX0104A PV/Deskew fixture
- 50Ω SMA terminator that accompanies the MX0104A fixture
- N2787A probe positioner (recommended) to hold the probe in place during the procedure

### To perform calibration

- 1 Connect the MX0023A probe to an oscilloscope channel.
- 2 On the oscilloscope menu, click **Setup** > **Probe Calibration** to access the Probe Calibration dialog box.



- 3 In the tab that represents the channel to which your probe is connected, click the **Start Atten/Offset Cal...** button to initiate the DC gain/offset calibration.
- 4 The **DC Offset/Gain Cal** dialog box is displayed with a guided procedure for calibration. Verify that the probing diagram matches your probing setup. If it does not match, configure the probing components in the Probe Configuration dialog box (see [page 126](#)). If it matches, click **Next** to proceed.



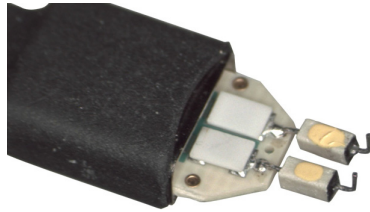
The next screen in the guided procedure requires the usage of the MX0104A deskew fixture in this calibration.

- 5 To use the MX0104A deskew fixture:
  - a Connect the 50  $\Omega$  terminator to the MX0104A fixture. This terminator is provided with the fixture.
  - b Connect the MX0104A fixture to the **Cal Out** connector on the oscilloscope.
  - c Turn the nut on the Cal Out connector counter-clockwise to tighten. While holding the fixture upright with one hand, use an 8 in. lbs. torque wrench to fully tighten the connector.



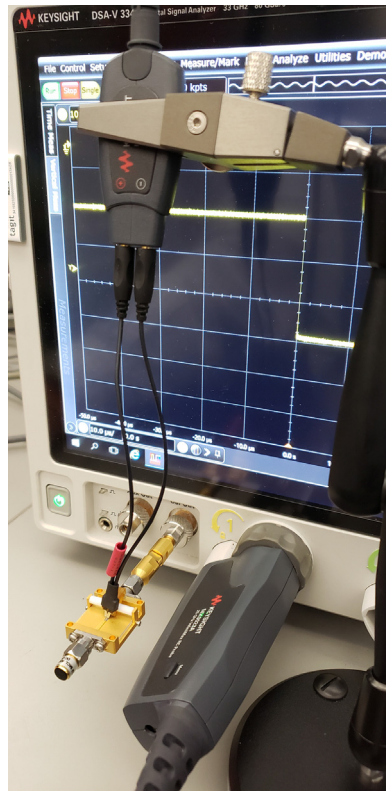
**Figure 74** MX0104A deskew fixture connected to oscilloscope's Cal Out connector

- d For the solder-in and ZIF probe heads, adjust the shape of the probe head tips as shown in the following figure before you clamp these to the deskew fixture. This is needed to ensure a proper contact with the deskew fixture.



- e Use the N2787A 3D Probe Positioner to hold the probe in place and to maintain a steady contact of probe tips with the deskew fixture.

**NOTE** Make sure that the probe head is approximately perpendicular to the deskew fixture.



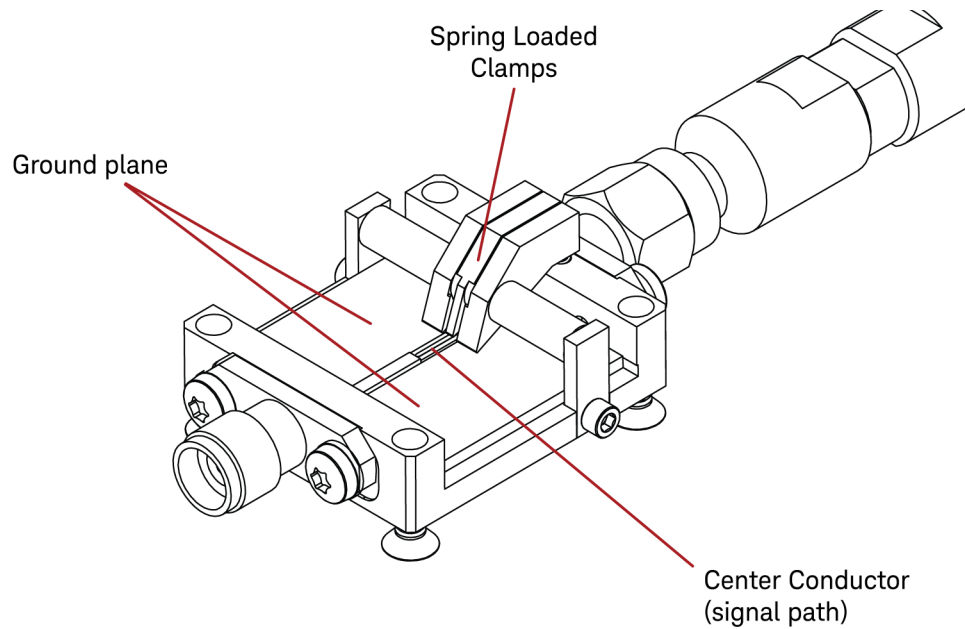
- f While pressing down on the MX0104A fixture's spring-loaded clamps, insert the probe head tips beneath the clamps. Place the positive tip of the probe head on the center conductor of the deskew fixture. The negative tip or ground lead of the probe head must be connected to the ground plane on either side of the center conductor of the deskew fixture. The MX0104A's

spring loaded clamps, ground plane, and center conductor (signal path) are labeled in the following figure.

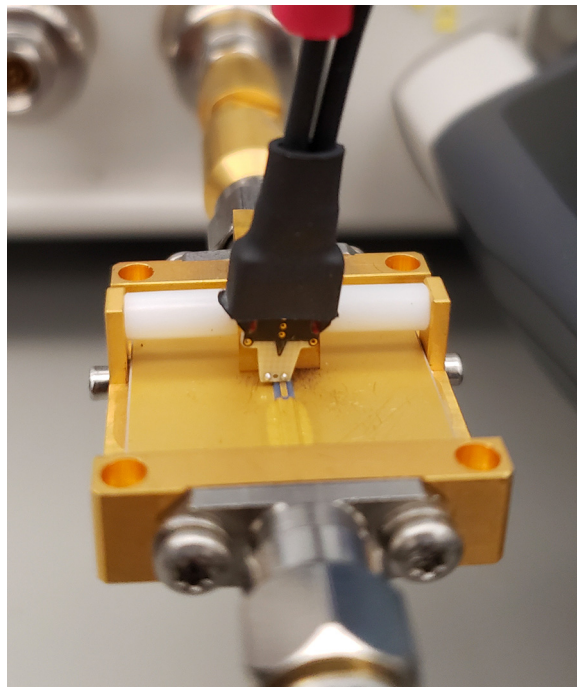
**CAUTION**

Do not press down with much force to avoid snapping off the fixture from the Cal Out connection. Only a light contact is needed for the calibration.

---



The clamping of the probe head to the deskew fixture is shown below.



**NOTE**

You can verify whether or not the probe head's leads are correctly connected to the MX0104A deskew fixture by pressing the oscilloscope's autoscale button. If a stable step is displayed on screen, it indicates a good connection. You will need to re-open the Probe Calibration dialog box after performing this verification step.

---

- 6 After the probe is properly connected to the deskew fixture, click the **Start Cal...** button to begin the DC gain/offset calibration.
- 7 Similarly, perform the skew calibration once the DC gain/offset calibration is successfully done. Use the **Start Skew Cal...** button in the Probe Calibration dialog box to initiate skew calibration.



## 12 Making Measurements

Probing Single-ended Signals using a Differential Probe Head	138
Extreme Temperature Probing	139
Probing Ungrounded Devices	141
Blocking out the DC Component of the Input Signal	142

## Probing Single-ended Signals using a Differential Probe Head

All the supported probe heads of the MX0023A probe amplifier are differential. You can use a differential probe head to probe single-ended as well as differential signals. Differential probe heads can help you make better measurements on single-ended signals than single-ended probe heads by providing higher bandwidth and increased accuracy. In addition to these advantages, any supplied offset is applied only to the probe head's plus side resulting in no offset range being sacrificed.

For a single-ended signal measured with a differential probe head, the offset is applied at the probe to preserve dynamic range. It is added to or subtracted from the positive leg of the probe to bring a signal within the probe's dynamic range. For a differential signal, the offset is applied at the oscilloscope channel.

This method of applying probe offset allows the full benefits of differential probing for single-ended signals without sacrificing offset range.

### See Also

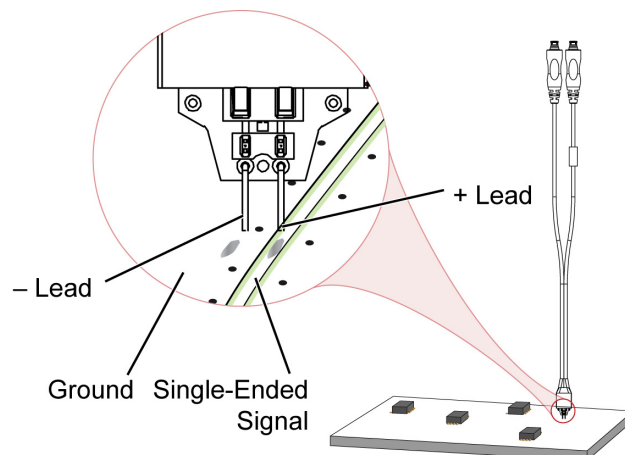
["Configuring Offset Behavior"](#) on page 129

### Connection for a single-ended signal using a differential probe head

Connect the probe head's "+" lead to the single-ended signal. Connect the probe head's "-" lead to ground.

#### NOTE

The + and - connections for the differential probe head can be determined when the probe head is plugged into the probe amplifier. The polarity markings on the probe amplifier represent the + and - inputs on the differential probe head. The positive (+) and negative (-) leads of the probe head get reversed by swapping the probe head's connections at the probe amplifier.



If possible, orient the probe head vertically. Laying the probe head flat causes coupling to the probe head tip that can degrade the probe performance.

## Extreme Temperature Probing

You may need to monitor a system in a temperature chamber with an oscilloscope probe to verify performance over a wide range of operating temperatures, or to determine the cause of failures at high or low temperatures. The MX0023A probe amplifier has a specified operating temperature range from 5 to 40 °C. However, the probe heads such as MX0100A and MX0106A can be operated over a much wider range (-55°C to +150°C). You can use the N5450B extension cable set to physically separate the probe heads from the probe amplifier. This allows you to operate these probe heads inside a temperature chamber with the probe amplifier located outside the temperature chamber.

### InfiniiMax RC Probe Heads Supporting Extreme Temperature Testing

**Table 21** Probe Heads Extreme Temperature Ranges

Probe Head	Operating Temperature Range (°C)	Expected Lifetime of the Probe Head (cycles)
MX0100A	-55° C dwell, 1000 hours minimum +150° C dwell, 1000 hours minimum -55° C to 150° C cycles, 1000 cycles minimum (as per JEDEC JESD22-A104 revision E)	> 1000
MX0106A	-55° C dwell, 1000 hours minimum +150° C dwell, 1000 hours minimum -55° C to 150° C cycles, 1000 cycles minimum (as per JEDEC JESD22-A104 revision E)	> 1000
N5425B + N5426A ZIF tip	-40 to +85	> 500
N5425B + N5451A ZIF tip	-25 to +80	> 1000

#### NOTE

Cycling probe heads through extreme temperature ranges has a marked effect on their lifetimes as listed in **Table 21**. Therefore, you should keep your extreme temperature testing probe heads separate from the probes they use under milder conditions. By doing this, you can ensure that the extension cables and probe amplifier are not impacted or need to be replaced with extended temperature cycling.

### Probe Heads Discoloration

The probe heads that support extreme temperature testing may undergo discoloration/texture changes when used under high temperatures. However, such changes do not affect the probe head's performance or measurement quality.

The probe head maintains its specified frequency response and bandwidth over the operating temperature range ( $-55^{\circ}\text{C}$  to  $+150^{\circ}\text{C}$ ), without any need for compensation or correction.

A few examples of such discoloration are shown below.



### Cautions Associated with Extreme Temperature Testing

- CAUTION

Avoid rapid changes in temperature that can lead to moisture accumulating in the form of condensation on the probe components, as well as the DUT. If this occurs, wait until the moisture has evaporated before making any measurements.
- CAUTION

Additional care must be taken when handling probe heads used during extreme temperature cycling because this process makes the probe heads less robust.
- CAUTION

Secure the ends of the extension cable near the probe head in the temperature chamber such that the probe head legs are not tugged or moved around significantly.
- CAUTION

Prevent abrasion and tears in the cable's jacket, do not rest the extension cables on any metal objects or objects with sharp edges.
- CAUTION

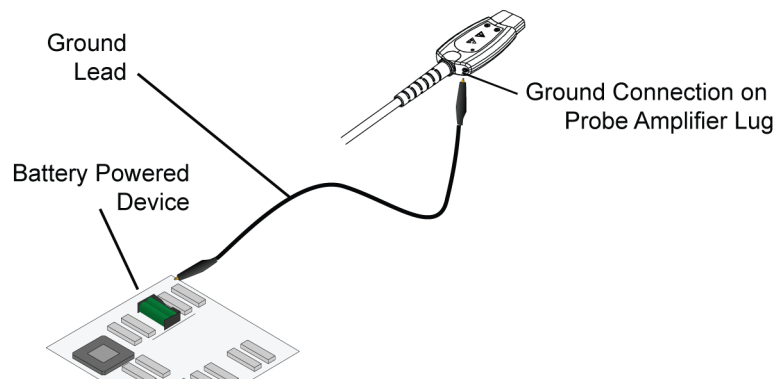
Do not kink the cables. The cables are designed to be flexible, but are not designed to be bent sharply.

## Probing Ungrounded Devices

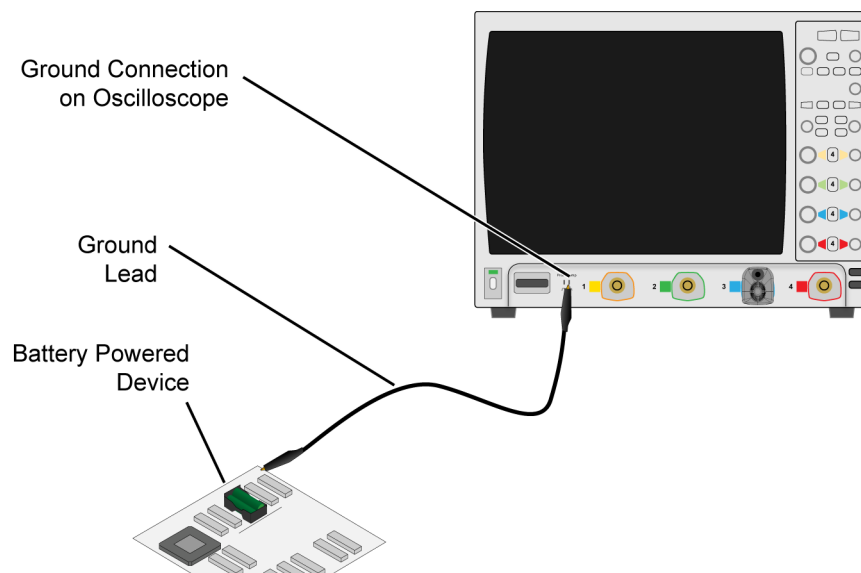
For any probing setup, the DUT needs to be grounded to the oscilloscope via the AC mains ground before connecting the DUT to a probe head. In case of ungrounded devices such as a battery-powered device where the DUT is not grounded to the oscilloscope via the AC mains ground, you can establish the ground connection in the following two ways:

- Connect the DUT ground to the probe amplifier ground.
- Connect the DUT ground to the oscilloscope ground.

Use a ground wire to make this ground connection.



**Figure 75** Connecting DUT Ground to Probe Amplifier Ground



**Figure 76** Connecting DUT Ground to Oscilloscope Ground

## Blocking out the DC Component of the Input Signal

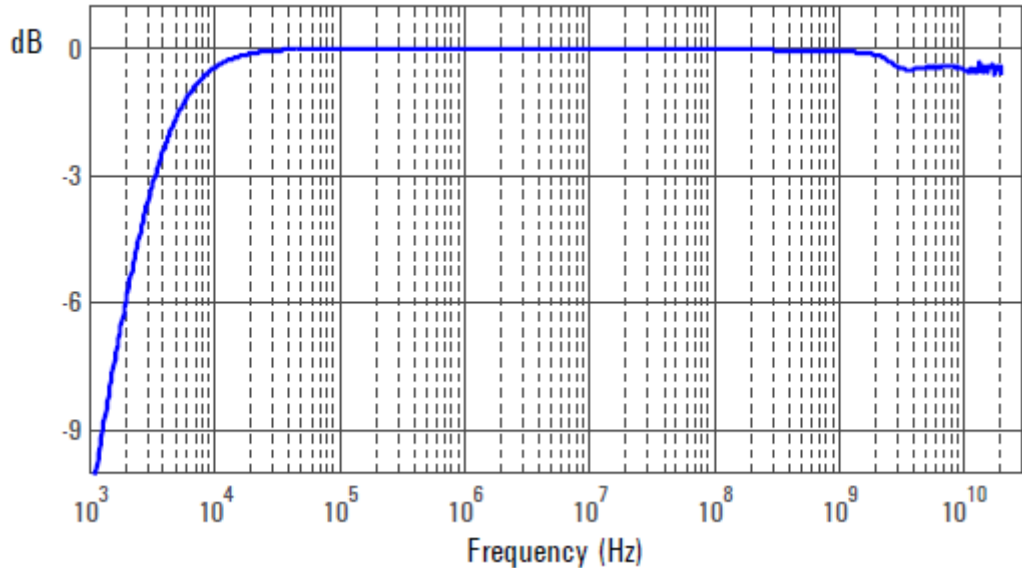
The N2881A InfiniiMax DC Blocking Capacitors block out the DC component of the input signal (up to 30 Vdc). You can place these DC blocking caps between the MX0023A probe amplifier and probe head.



**Figure 77** Placement of DC Blocking Capacitor Between a Probe Amplifier and a Probe Head

You can also use these DC blocking capacitor with the N2880A In-Line Attenuators. The order of the two products in the probing system (that is, which one is closer to the probe amplifier) does not matter.

**Figure 78** on page 142 shows the frequency response plot of the N2881A DC Blocking Capacitors (no probe included).



**Figure 78** Graph of DC Blocking Capacitor insertion loss (S2,1) versus frequency (DC Blocking Capacitor only)

# 13 InfiniiMax RC Probe Amplifier and Probe Heads System Responses

Typical Corrected System Frequency Response [144](#)

Typical Step Response of Corrected System [145](#)

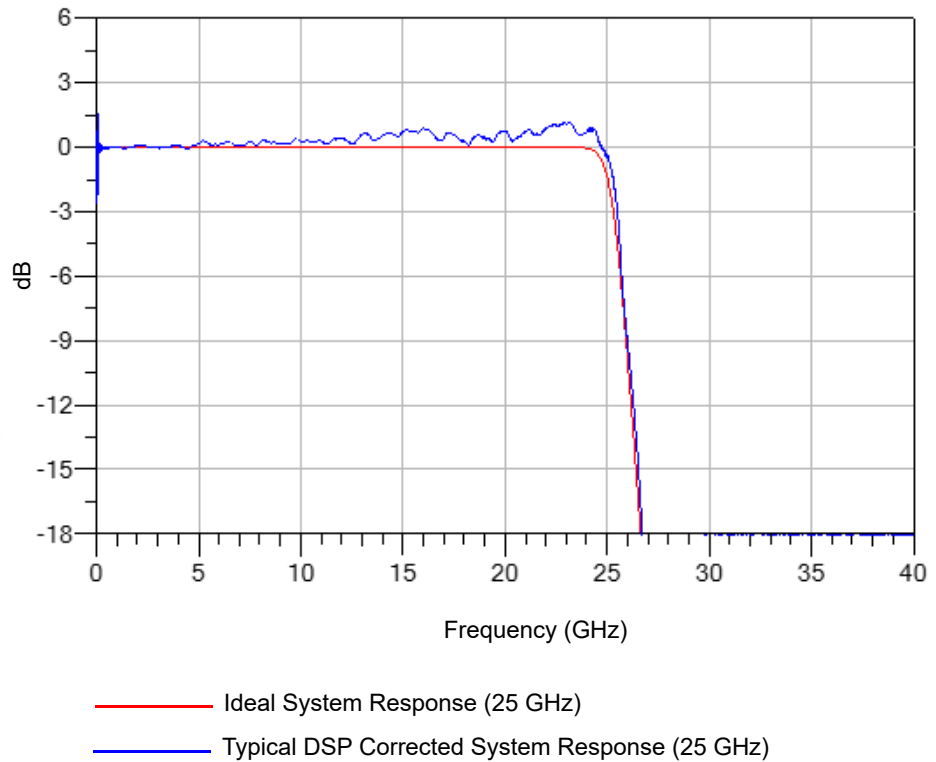
Typical CMRR [146](#)

InfiniiMax RC probe amplifiers with Infiniium real-time oscilloscopes utilize DSP correction filters to enhance the accuracy of measurements. InfiniiMax RC probe amplifiers store their unique s-parameters in on board memory for the oscilloscope to readout. Probe heads are simple passive devices and, with careful manufacture, their s-parameters don't vary significantly so these are stored as nominal s-parameters in the oscilloscope. When a probe is connected to an oscilloscope channel and the proper probe head is selected, the oscilloscope calculates a DSP correction filter that includes the probe head, probe amplifier, and oscilloscope channel. This provides the maximum measurement accuracy for the complete probe and oscilloscope channel system.

Since there are multiple probe amplifier and probe heads combinations, it is not reasonable to show the frequency responses of all these combinations. This chapter provides a typical corrected response, step response, and CMRR for the MX0100A probe head and MX0023A probe amplifier combination. The responses would all be very much the same for all probe heads because they are all corrected to the same target system response at the bandwidth specified. The target system response is a flat magnitude, flat phase response high order low-pass Brickwall filter that maximizes measurement accuracy.

## Typical Corrected System Frequency Response

**Figure 79** shows the frequency response of an ideal 25GHz brickwall filter and the typical DSP corrected probe response filtered by the brickwall filter.



**Figure 79** Typical Corrected Frequency Response for the MX0100A Probe Head and 25 GHz MX0023A Probe Amplifier Combination

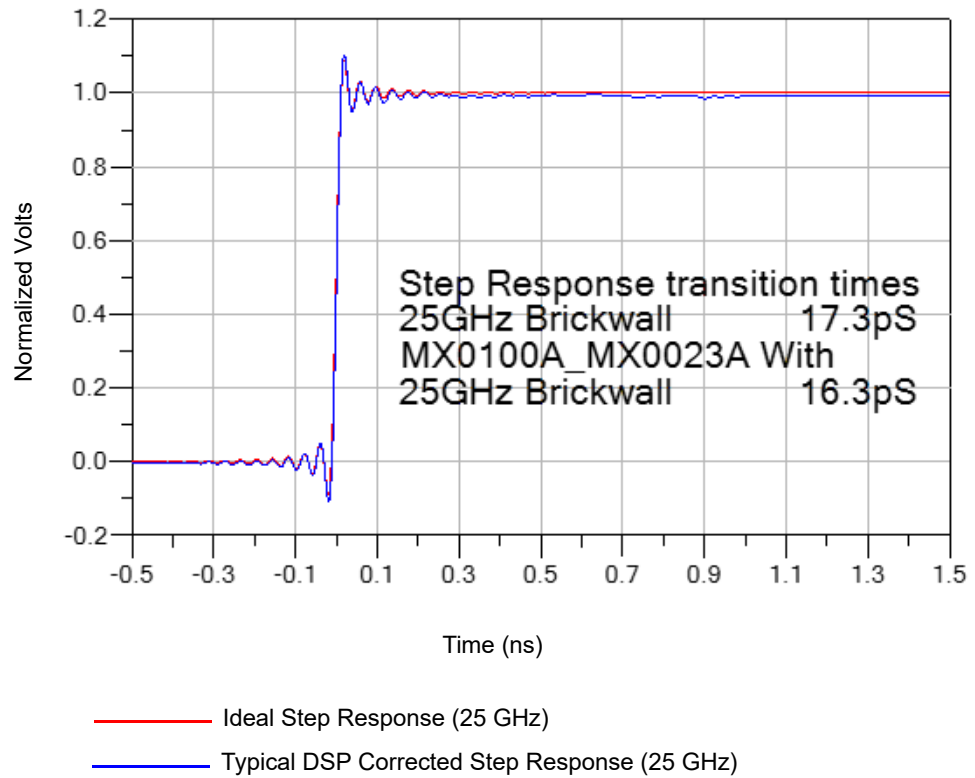


## Typical Step Response of Corrected System

Figure 80 shows the step responses for the following two responses:

- an ideal 25GHz system response and
- the typical DSP corrected probe response

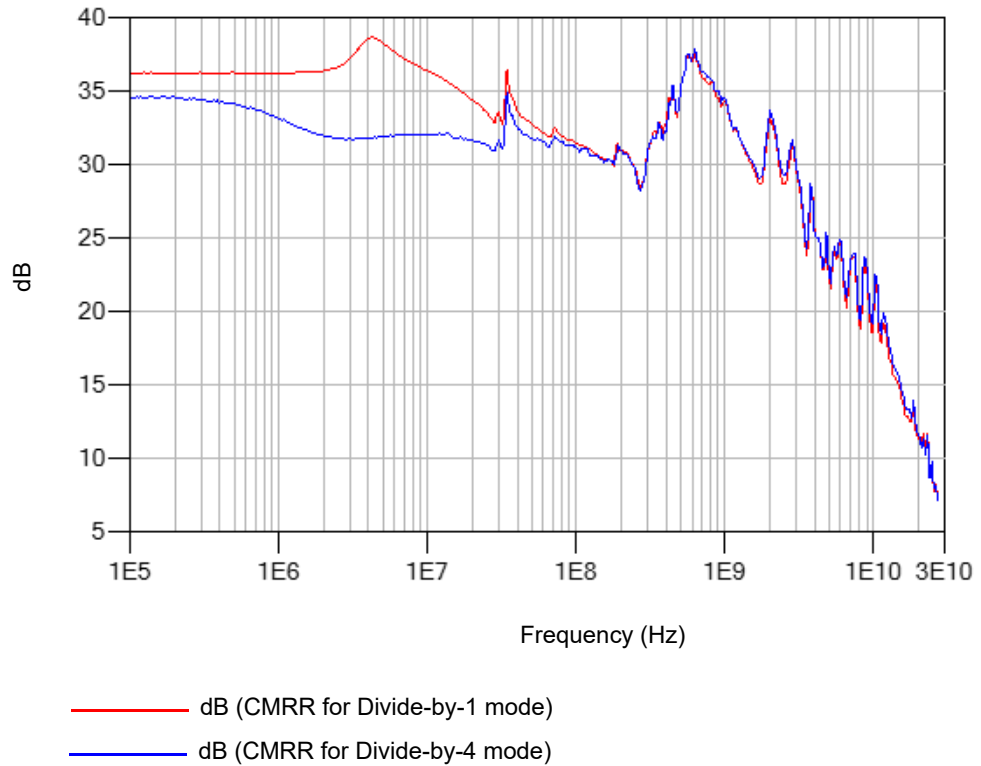
The configuration used is the MX0100A probe head with the 25 GHz MX0023A probe amplifier.



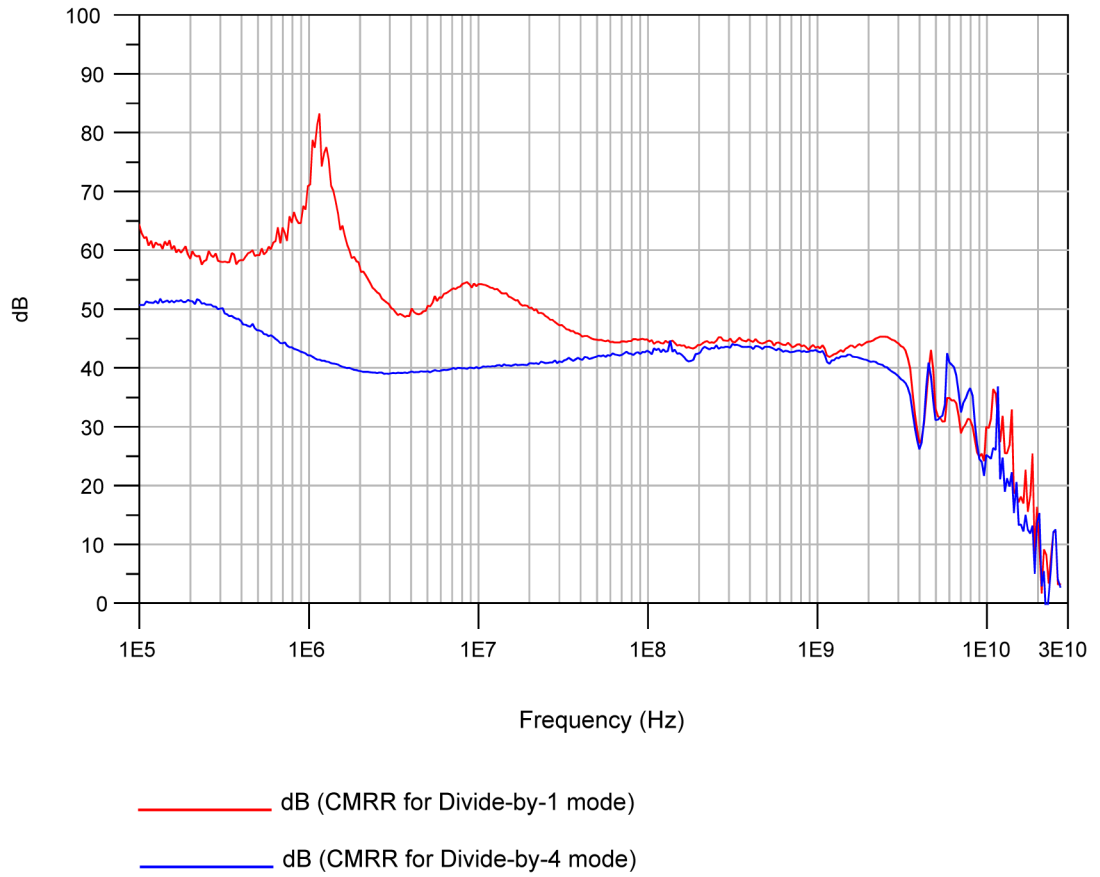
**Figure 80** Typical Corrected Step Response of the MX0100A probe head with MX0023A 25 GHz probe amplifier

## Typical CMRR

**Figure 81** shows the typical CMRR applicable to all probe heads described in this guide for the MX0023A probe amplifier except the MX0105A SMA probe head. The CMRR for the MX0105A probe head is shown in **Figure 82**.



**Figure 81** CMRR of MX0100A Probe Head With MX0023A 25 GHz Probe Amplifier



**Figure 82** CMRR of MX0105A Probe Head With MX0023A 25 GHz Probe Amplifier



# 14 Performance Verification

Before you Start	150
Recommended Test Interval	150
To Test Bandwidth	151
Required Test Equipment	151
Procedure	152
To Test Input Resistance	157
Required Test Equipment	157
Procedure	157
Performance Test Record	161

This chapter describes how to verify the bandwidth performance of your MX0023A probe.

## Before you Start

**CAUTION**

Electrostatic discharge (ESD) can quickly and imperceptibly damage or destroy high performance probes, resulting in costly repairs. Always wear a wrist strap when handling probe components and ensure that cables are discharged before being connected.

---

**NOTE**

Allow the probe to warm up for at least 20 minutes.

---

### Recommended Test Interval

The recommended test interval is 1 year.

## To Test Bandwidth

The following procedure can be used to test and verify that the probe meets its warranted bandwidth specification.

Probe Amplifier	Probe Head	Warranted Specification	
MX0023A 25 GHz Probe Amplifier	MX0100A Micro Probe Head	Bandwidth	25 GHz (with 60 mil leads of probe head)

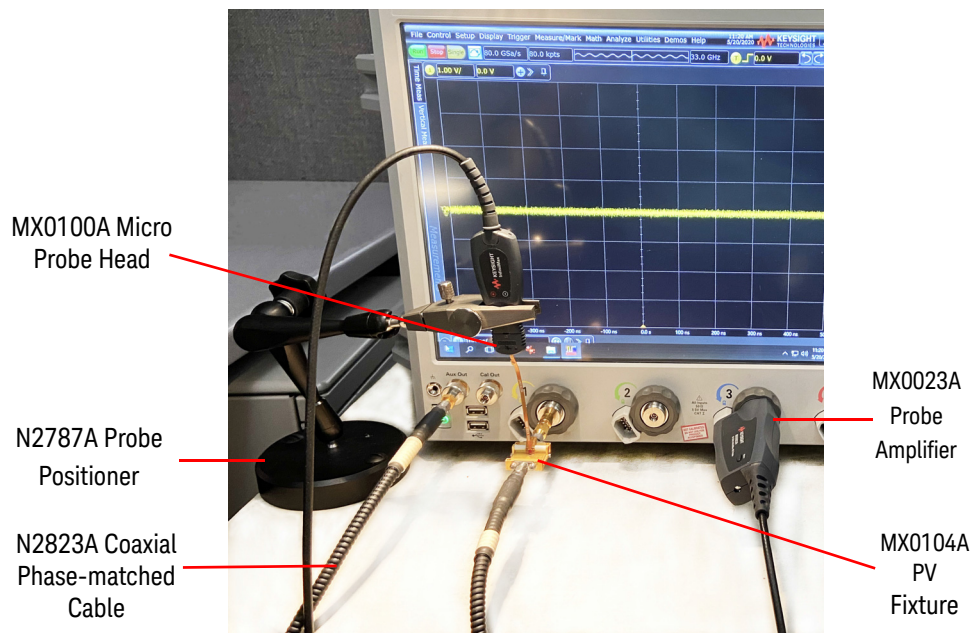
### Required Test Equipment

**Table 22** Required Test Equipment for Bandwidth Verification

Description	Critical Specification(s)	Recommended Models / Part Numbers and Adapters	Purpose
Oscilloscope	<ul style="list-style-type: none"> <li>A compatible Infiniium oscilloscope with AutoProbe II or AutoProbe III interface</li> <li>At least two 33 GHz or higher input channels</li> </ul>	90000 Q, V, X, Z-series UXR-series 33 GHz models UXR-series 40 GHz or higher with 1 mm (m) connector Required Adapters: Y1903B 1 mm ruggedized (f) to 2.92 mm (f) + N2852A AutoProbe II to AutoProbe III adapters UXR-series 40 GHz or higher with 1.85 mm Male connector Required Adapters: 11904B 2.4 mm (f) to 2.92 mm (f) + N2852A AutoProbe II to AutoProbe III adapters	To display probe output
Coaxial Cable or equivalent		N2823A coaxial phase-matched cable	To connect the PV fixture to the AUX Out on oscilloscope
Probe Positioner		N2787A 3D probe positioner	To hold the probe in place during the procedure
PV Fixture		MX0104A performance verification fixture	
Probe Amplifier (to be verified)	MX0023A 25 GHz InfiniiMax probe amplifier	MX0023A 25 GHz InfiniiMax probe amplifier	
Probe Head	MX0100A 25 GHz Micro probe head	MX0100A 25 GHz Micro probe head	

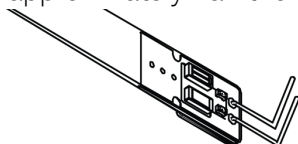
## Procedure

- 1 Choose **Control** > **Default Setup** or press the **[Default Setup]** key on the front panel of the oscilloscope to configure the oscilloscope to its default settings.
- 2 Make connections to any two input channels of the oscilloscope as described in the following steps. A typical connection setup is illustrated in **Figure 83**.
  - a Connect the MX0104A PV fixture to one of the channels of the oscilloscope and then turn on the channel connector to tighten.
  - b Connect one end of the coaxial cable to the MX0104A PV fixture and the other end to the **Aux Out** connector on the front panel of the oscilloscope.
  - c Connect the MX0023A probe amplifier to another channel of the oscilloscope. Use appropriate adapter(s) as indicated in **Table 22**.
  - d Connect the probe head to the probe amplifier and then clamp the probe head in the probe positioner. Make sure that the probe head is approximately perpendicular to the PV fixture.



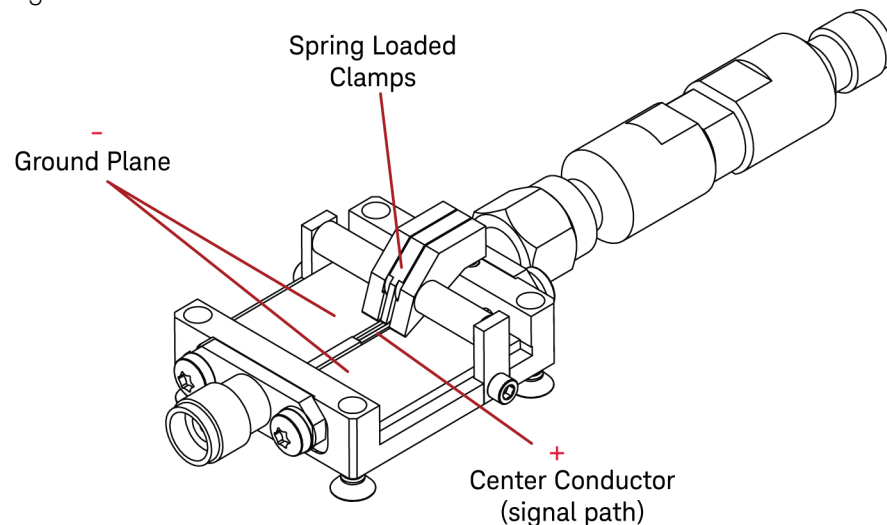
**Figure 83** Performance Verification Setup for MX0023A

- 3 Trim the MX0100A probe head's lead wires to **60 mil.** (This probe head is shipped with the factory-trimmed standard length of 135 mil.)
- 4 Form the tip wires of the probe head into an "L" shape with the bend at approximately half the wire length as illustrated in the following figure.





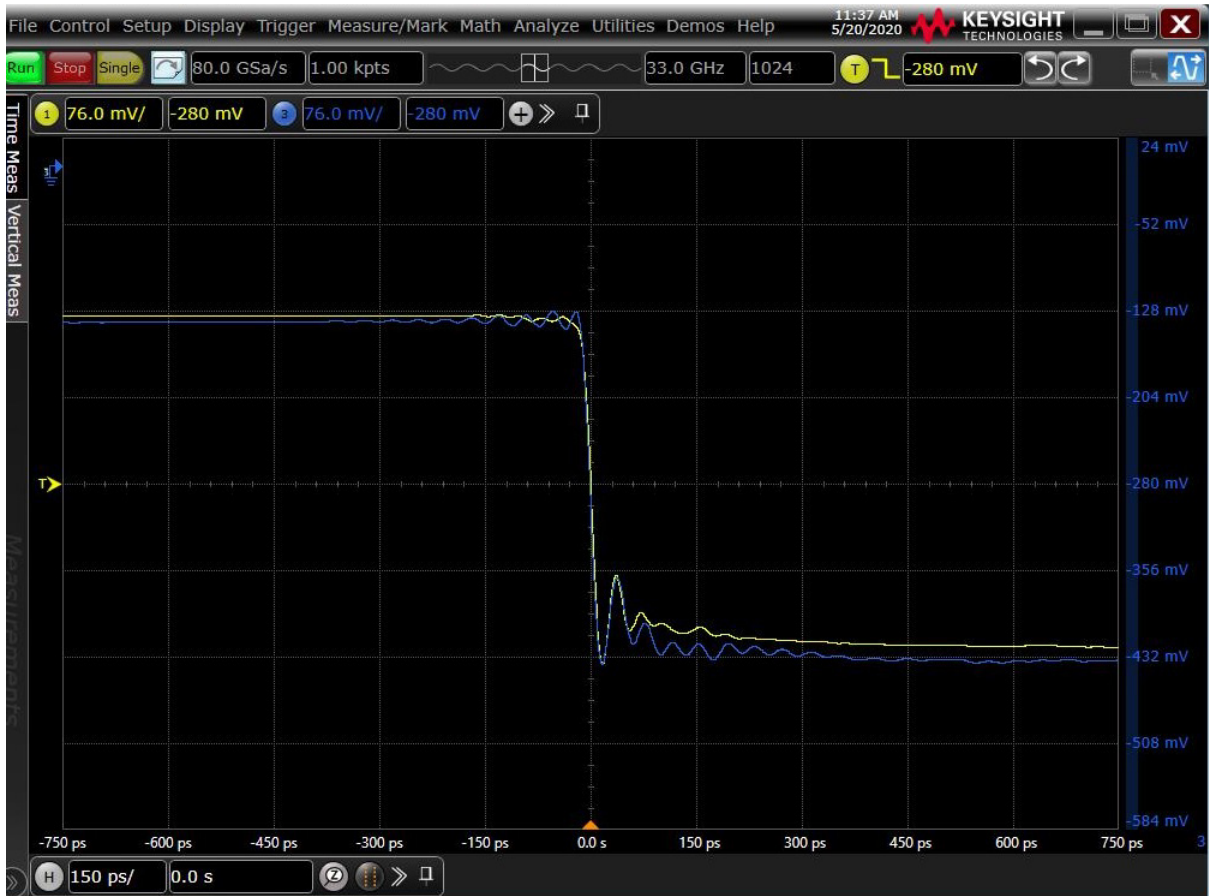
- 5 Open the MX0104A PV fixture's spring-loaded clamps and position the probe head tips beneath the clamps. Place the positive (+) tip of the probe head on the center conductor (signal path) of the PV fixture. The negative (-) tip of the probe head must be connected to the ground plane located on either side of the center conductor of the PV fixture. The MX0104A's spring loaded clamps, ground plane, and center conductor (signal path) are labeled in the following figure.



**Figure 84** Signal Path and Ground Locations on PV Fixture

- 6 Configure the oscilloscope as per the following settings:
- a Click **Utilities > Calibration Output** and then select the **Aux Out Enable** checkbox to turn on the Aux output.
  - b Set the vertical scale of the channel to which you connected the PV fixture to **76 mV/div** and center the waveform (offset **~ -280 mV**).
  - c Set the trigger to the channel to which you connected the PV fixture and set the trigger level to **~ -280 mV negative slope**.
  - d Click **Setup > Acquisition**. In the **Acquisition** dialog box, enable averaging and set **# of Averages** to **1024**.
  - e Set the horizontal scale to **150 pS/div**.
  - f Click **Setup > Probe Configuration** and set the **Probe Offset Behavior** to **Probe**.
  - g Set the vertical scale of the channel to which you connected the probe amplifier to **76 mV/div** and the offset to **~ -280 mV**.
  - h If needed, adjust the probe amplifier channel's skew to just about horizontally center the negative step along with the fixture channel.

After configuring the above-mentioned settings, the oscilloscope display should be similar to the following screen.



- 7 Click **Math > Functions....** In the **Function** dialog box, define the functions f1, f2, f3, and f4 as follows:
  - a Select the tab of the function **f1** to define it.
  - b From the **Function 1** listbox, select **Math** and then **Differentiate**.
  - c From the **Source 1** drop-down listbox, select the input channel of the oscilloscope to which you connected the PV fixture.
  - d Deselect the **Low Pass and Align Phase** checkbox.
  - e Do not select the **On** checkbox for f1.
  - f Select the tab of the function **f2** to define it.
  - g From the **Function 2** listbox, select **FFT** to set f2 to be an FFT of f1.
  - h Turn the function display on for f2 by selecting the **On** checkbox.
  - i Select the tab of the function **f3** to define it.
  - j From the **Function 3** listbox, select **Math** and then **Differentiate**.
  - k From the **Source 3** drop-down listbox, select the input channel of the oscilloscope to which you connected the probe amplifier.
  - l Deselect the **Low Pass and Align Phase** checkbox.

- m Do not select the **On** checkbox for f3.
  - n Select the tab of the function **f4** to define it.
  - o From the **Function 4** listbox, select **FFT** to set f4 to be an FFT of f3.
  - p Turn the function display on for f4 by selecting the **On** checkbox.
- 8 Move the f4 trace into the same graticule as the f2 trace using the mouse. Turn off the graticule that is left unused after this movement.
  - 9 Set both f2 and f4 FFTs to **3 dbm/div** and the stop frequencies to **50 GHz**.
  - 10 Move both f2 and f4 traces up to the center screen using the mouse. Overlay the left side of the traces.

After configuring the above-mentioned settings, the oscilloscope display should be similar to the following screen. f2 is the FFT of the PV fixture and f4 is the FFT of the probe amplifier.



- 11 Check the probe response FFT (f4). It should not be more than 3 db below the fixture response FFT (f2) at up to 25 GHz (which is at center screen).
- 12 At this step, the probe amplifier is in the 4:1 attenuation mode as the vertical scale of the channel to which you connected the probe amplifier was set to **76**

**mV/div.** Change the vertical scale of this channel to **75 mV/div** to configure the probe in the 1:1 attenuation mode.

- 13** Check the probe response FFT (f4). It should not be more than 3 db below the PV fixture response FFT (f2) at up to 25 GHz (which is at center screen).

If the checks performed in **step 11** and **step 13** pass, then the probe amplifier has passed the performance verification test.

## To Test Input Resistance

This procedure tests that the probe meets its warranted input resistance.

Probe Amplifier	Probe Head	Specification	
MX0023A 25 GHz Probe Amplifier	MX0100A Micro Probe Head	DC Input Resistance	$R_{diff} = 50 \text{ kW} \pm 2\%$ $R_{se} = 25 \text{ kW} \pm 2\%$

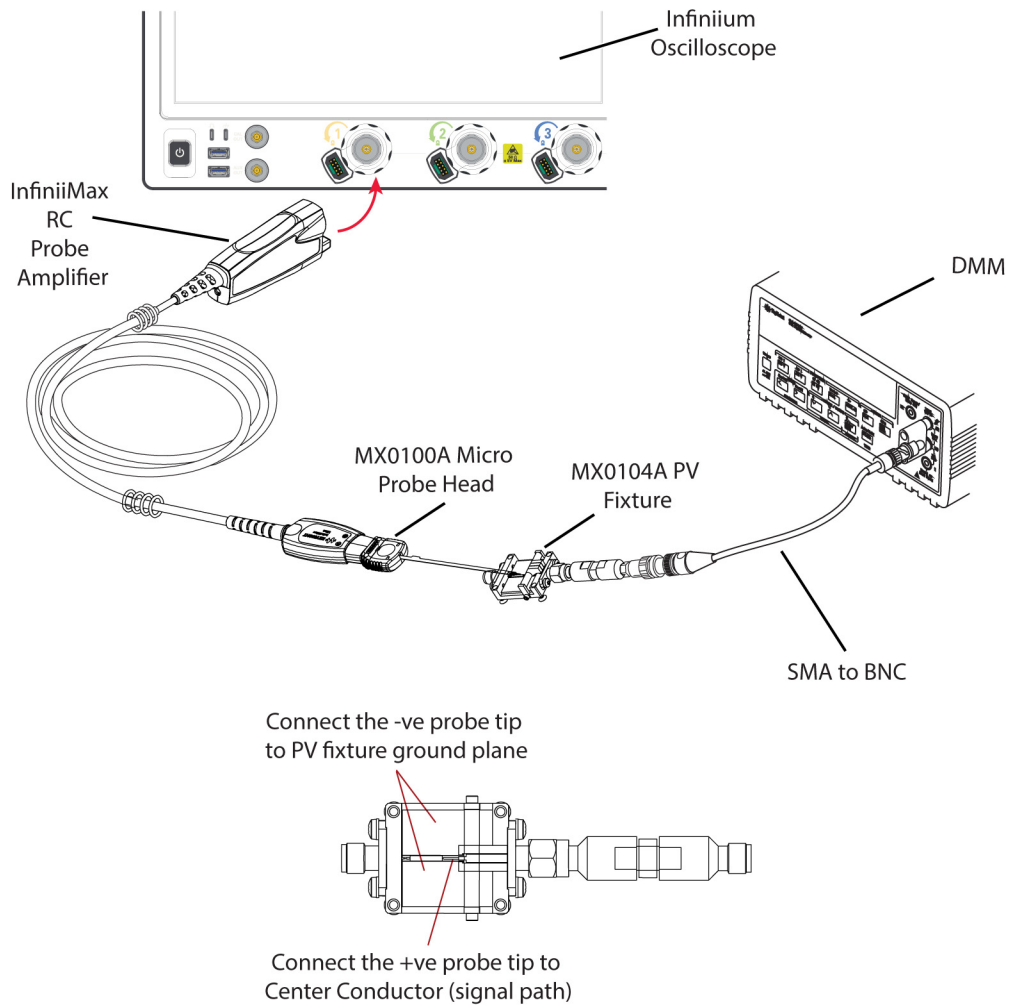
### Required Test Equipment

Description	Critical Specification(s)	Recommended Models / Part Numbers	Purpose
Oscilloscope	A compatible Infiniium oscilloscope with AutoProbe II interface	UXR-series (3.5 mm models) 90000 Q, V, X, Z-series	To provide probe power
Digital Multimeter	2 wire resistance accuracy > $\pm 0.01\%$	34461A Digital Multimeter	To measure and display Input Resistance for the probe
PV Fixture		MX0104A performance Verification Fixture (recommended) or E2655C (substitute)	
Adapter	SMA (m) to BNC (f)	E2655-83201 (in E2655C Kit) or Any other equivalent SMA (m) to BNC (f) adapter	To connect the PV fixture to the DMM
Probe Amplifier (to be verified)	InfiniiMax Ultra Series probe amplifier	MX0020A/21A/22A/24A/25A probe amplifier	
Probe Head	MX0100A 25 GHz Micro probe head	MX0100A 25 GHz Micro probe head	

### Procedure

- 1 Power on the Infiniium oscilloscope and 34461A DMM.
- 2 Connect the probe amplifier under test to Channel 1 of the Infiniium oscilloscope.
- 3 Select the 2-wire Ohm display on the 34461A DMM.

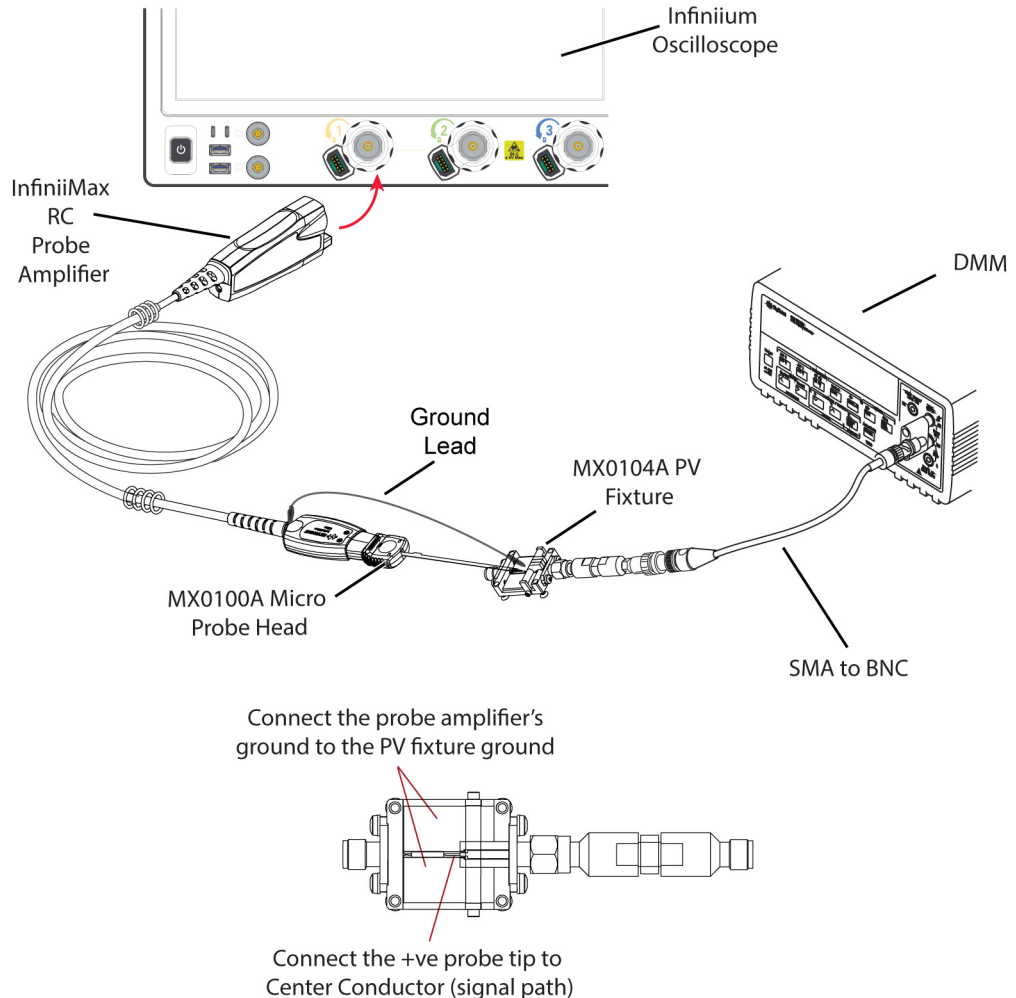
- 4 For Differential test, perform the following steps.
  - a Using the PV fixture, connect the positive (+) and negative (-) probe tips to the input terminals of the 34461A DMM as shown in the following figure.



**Figure 85** Connections for Differential Test

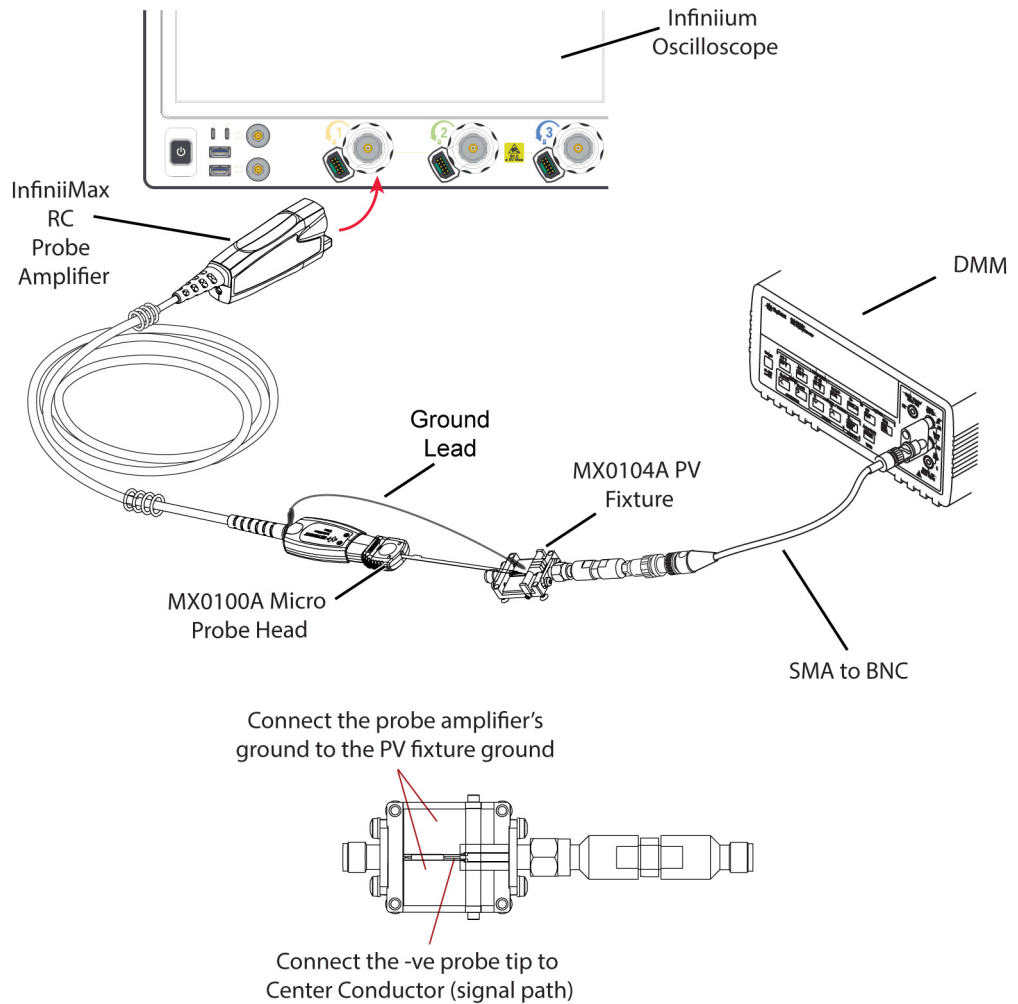
- b Apply upward pressure to the clip to ensure proper electrical connection.
- c Read the 34461A display for the input resistance.
- d Record the result in the performance test record given at the end of this chapter. To pass this test, the result should be between 49 kW and 51 kW.

- 5 For Single-ended test, perform the following steps.
- a Using the PV fixture, connect the positive (+) probe tip to the input terminal of 34461A DMM and connect the probe amplifier's ground to the PV fixture ground. The connections are illustrated in the following figure.



**Figure 86** Connections for Single-ended Test (positive probe tip measurement)

- b Apply upward pressure to the clip to ensure proper electrical connection.
- c Read the 34461A display for the input resistance.
- d Record the result in the performance test record given at the end of this chapter. To pass this test, the result should be between 24.5 kW and 25.5 kW.
- e Using the PV fixture, connect the negative (-) probe tip to the input terminal of 34461A DMM and connect the probe amplifier's ground to the PV fixture ground. The connections are illustrated in the following figure.



**Figure 87** Connections for Single-ended Test (negative probe tip measurement)

- f** Apply upward pressure to the clip to ensure proper electrical connection.
- g** Read the 34461A display for the input resistance.
- h** Record the result in the performance test record given at the end of this chapter. To pass this test, the result should be between 24.5 kW and 25.5 kW.



## Performance Test Record

**Table 23** Performance Test Record

<b>Model #:</b>	<b>Date:</b>	<b>Tested by:</b>	
<b>Serial #:</b>	<b>Recommended next test date:</b>		
<b>Test</b>	<b>Test Limits</b>	<b>Result</b>	<b>Pass/Fail</b>
Bandwidth (-3 dB)	25 GHz		
Input Resistance	50 kW $\pm$ 2% (Differential Mode) 25 kW $\pm$ 2% (Single-ended Mode)		



# 15 Returning a Probe/Probe Head for Repair/Service

If the probe amplifier / probe head is found to be defective or not meeting performance specifications, it is recommended to send it to a Keysight authorized service center for all repair and service needs.

If the probe amplifier / probe head is under warranty, normal warranty services apply. If the probe amplifier / probe head is not under warranty, repair costs will be applied.

## WARNING

**Do not install substitute parts or perform any unauthorized modification to the probe amplifier / probe head. Only Keysight service centers should perform repair/maintenance on the equipment.**

---

**Only Keysight approved accessories should be used.**

---

Perform the following steps before shipping the probe amplifier / probe head back to Keysight Technologies for repair / service.

- 1 Contact your nearest Keysight sales office for any additional details.
- 2 Write the following information on a tag and attach it to the malfunctioning equipment.
  - Name and address of owner
  - Product model number (for example, MX0023A)
  - Product Serial Number (for example, MYXXXXXXXX)
  - Description of failure or service required

## NOTE

**Include probe heads and accessories if the probe is not meeting performance specifications or a yearly calibration is requested.**

---

- 3 Protect the probe by wrapping in plastic or heavy paper. Use original packaging or comparable.
- 4 Pack the probe in the original carrying case or if not available, use bubble wrap or packing peanuts.

- 5 Place securely in a sealed shipping container and mark container as "FRAGILE".  
If any correspondence is required, refer to the product by serial number and model number.

### Contacting Keysight Technologies for Technical Assistance

For technical assistance, contact your local Keysight Call Center.

- In the Americas, call 1 (800) 829-4444
- In other regions, visit <http://www.keysight.com/find/assist>

Before returning an instrument for service, you must first call the Call Center.

# 16 Replacement Parts

MX0100A Probe Head	165
MX0106A Probe Head	165
N2839A Browser Head	166
Other Replacement Parts	166

## MX0100A Probe Head

**Table 24** MX0100A Replacement Parts

Description	Qty	Order Part Number
Probe Tip Wire (.004" diameter) <i>(To make ground connections)</i>	1 wire spool	MX0102-21301

## MX0106A Probe Head

**Table 25** Replacement Wires

Description	Qty	Order Part Number
0.007 tin-plated nickel wire and trim gauge	1	01169-81301
0.004 tin-plated nickel wire and trim gauge	1	MX0102-21301

## N2839A Browser Head

**Table 26** N2837A Replacement Tip Kit

Description	Qty Supplied
Spring-loaded tips (0.0115 in. diameter, 0.126 in. long)	20
Straight probe tips (0.003 in. diameter, 0.113 in. long)	20

## Other Replacement Parts

**Table 27** Other Replacement Parts

Description	Vendor	Part Number	Qty
Probe Amplifier Ground Wire	–	01131-21301	1
160Ω damped wire accessory (01130-21303 34 each)	Keysight	E5381-82103	1
Coupling tag for N5450B extreme temperature cable extension	Keysight	N5450-21201	1
SMA coaxial dc block	Inmet	#8037	1
SMA 6 dB coaxial attenuator	Inmet	#18AH-6	1
SMA 12 dB coaxial attenuator	Inmet	#18AH-12	1
SMA adjustable delay	ATM Microwave	#P1907	1
GPO-F to GPO-F adapter for N5380B	Corning Gilbert Rosenberger	#A1A1-0001-03 #19K 109-K00 E4	2

# Index

## Numerics

11904B, [151](#)  
3D probe positioner, [23](#)

## A

AC mains ground, [141](#)  
AC response calibration, [131](#)  
accessories  
  static-safe, [32](#)  
accurate measurements, [126](#)  
adapter, [11](#)  
additional N2839A tips, [83](#)  
attenuation, [10](#)  
attenuators, [126](#)  
AutoProbe II, [8](#)  
AUX Out, [151](#)  
Aux Out, [152](#)

## C

Cal Out connector, [133](#)  
calibration, [131](#)  
calibration sequence, [131](#)  
calibrations, [131](#)  
cleaning, [41](#)  
CMRR, [143](#)  
corrected frequency  
  response, [144](#)  
correction filter, [10, 128](#)

## D

DC Blocking Capacitors, [142](#)  
DC blocking capacitors, [126](#)  
DC component, [142](#)  
DC gain, [132](#)  
deskew, [132, 133, 134](#)  
deskew fixture, [132](#)  
differential, [138](#)  
discoloration of probe  
  heads, [139](#)  
DSP correction filter, [143](#)  
DUT ground, [141](#)

## E

E2669B Differential  
  Connectivity Kit, [25](#)

environmental chamber, [19](#)  
ESD, [32](#)  
ESD wrist strap, [32](#)  
extension cables, [126](#)  
extreme temp, [19](#)  
extreme temperature  
  testing, [79](#)

## F

fine wire ZIF tip, [101, 116](#)

## G

generic probe head, [128](#)  
ground connection, [9, 141](#)  
ground socket, [32](#)  
ground wire, [141](#)

## I

InfiniiMax III, [14](#)  
InfiniiMax RC probe heads, [14](#)  
Infiniium oscilloscopes, [11](#)  
Infiniium software, [125](#)  
Infiniium software version, [11](#)  
in-line attenuators, [142](#)  
input impedance, N2839A, [87](#)  
input range, [10](#)  
input resistance  
  verification, [157](#)  
isolation, [32](#)

## L

long wire ZIF tip, [101](#)  
low temperature hot glue, [38](#)

## M

menu button, [8](#)  
moving across different  
  probing locations, [35](#)  
moving probing setup, [35](#)  
MX0100A dimensions, [52](#)  
MX0100A input impedance, [53](#)  
MX0100A lead wires, [56](#)  
MX0100A sPICE model, [54](#)  
MX0100A strain relief, [60](#)  
MX0102A, [20](#)

MX0104A, [23, 132, 133, 151,](#)  
  [157](#)

MX0106A dimensions, [69](#)  
MX0106A sPICE model, [71](#)

## N

N2787A, [23, 132, 134, 151](#)  
N2812B, [24](#)  
N2823A, [95, 151](#)  
N2837A kit, [83](#)  
N2839A supplied  
  accessories, [82](#)  
N2852A, [11, 151](#)  
N2880A InfiniiMax In-Line  
  Attenuator, [19](#)  
N2881A, [142](#)  
N2881A InfiniiMax DC Blocking  
  Capacitors, [20](#)  
N2884A fine wire ZIF tip  
  dimensions, [103](#)  
N5380B, [17](#)  
N5382A, [82](#)  
N5425B, [100](#)  
N5448B, [95](#)  
N5450B, [139](#)  
N5450B cable, [19](#)  
named probe head, [128](#)  
normal offset, [130](#)

## O

offset, [129, 138](#)  
offset calibration, [131, 132](#)  
offset range, [19](#)  
olarity markings, [9](#)  
oscilloscope ground, [35, 141](#)

## P

performance test record, [161](#)  
performance verification, [149](#)  
performance verification  
  fixture, [151, 157](#)  
phase matched cable, [24](#)  
plastic housing, [17](#)  
probe amplifier ground, [35,](#)  
  [141](#)  
probe family diagram, [15](#)

probe offset, 130  
 probe offset behavior, 129  
 probe positioner, 132  
 probe system, 126  
 probe system block diagram, 126  
 probing locations, 35  
 probing setup, 126  
 protective end cap, 83  
 putty, 38  
 PV stand, 23  
 PV/Deskew fixture, 23

## R

remove ZIF tip, 111  
 replacement parts, 166  
 resistor  
   dimensions, 74  
 robe's ground lead, 28

## S

S parameter, 128  
 s parameter, 56  
 safety, 28  
 Safety Considerations, 28  
 safety information, 28  
 safety warnings, 28  
 skew calibration, 131, 132  
 SMA connectors, 94  
 SMA shorting adapter, 95  
 soldering toolkit, 20  
 soldering ZIF tip, 112  
 spacing between wires, 73  
 s-parameters, 10, 143  
 SPICE model, N2839A, 85  
 spring-loaded tips, 83  
 standard ZIF Tip, 101  
 static-safe accessories, 32  
 static-safe workstation, 32  
 step response, 143  
 straight probe tips, 82  
 strain relief, 37  
 supported probe heads, 14  
 system bandwidth, 10

## T

Tack-putty, 38  
 temperature ranges, 139  
 test equipment for input  
   resistance verification, 157

trim gauge, 76  
 trim gauge template, 56

## U

ungrounded devices, 141

## V

Velcro dots, 39  
 Vout/Vin, 10

## W

warranted specifications, 43

## Y

Y1903B, 151

## Z

ZIF tip dimensions, 102  
 ZIF tips, 100