

# Keysight N2750/1/2A Differential Probes

User's Guide



## Notices

© Keysight Technologies, Inc. 2014, 2019

No part of this manual may be reproduced in any form or by any means (including electronic storage and retrieval or translation into a foreign language) without prior agreement and written consent from Keysight Technologies, Inc. as governed by United States and international copyright laws.

## Manual Part Number

N2750-97003

## Edition

February 2019

Keysight Technologies, Inc.  
1900 Garden of the Gods Road  
Colorado Springs, CO 80907 USA

## Warranty

The material contained in this document is provided "as is," and is subject to being changed, without notice, in future editions. Further, to the maximum extent permitted by applicable law, Keysight disclaims all warranties, either express or implied, with regard to this manual and any information contained herein, including but not limited to the implied warranties of merchantability and fitness for a particular purpose. Keysight shall not be liable for errors or for incidental or consequential damages in connection with the furnishing, use, or performance of this document or of any information contained herein. Should Keysight and the user have a separate written agreement with warranty terms covering the material in this document that conflict with these terms, the warranty terms in the separate agreement shall control.

## Technology Licenses

The hardware and/or software described in this document are furnished under a license and may be used or copied only in accordance with the terms of such license.

## U.S. Government Rights

The Software is "commercial computer software," as defined by Federal

Acquisition Regulation ("FAR") 2.101. Pursuant to FAR 12.212 and 27.405-3 and Department of Defense FAR Supplement ("DFARS") 227.7202, the U.S. government acquires commercial computer software under the same terms by which the software is customarily provided to the public. Accordingly, Keysight provides the Software to U.S. government customers under its standard commercial license, which is embodied in its End User License Agreement (EULA), a copy of which can be found at <http://www.keysight.com/find/sweula>. The license set forth in the EULA represents the exclusive authority by which the U.S. government may use, modify, distribute, or disclose the Software. The EULA and the license set forth therein, does not require or permit, among other things, that Keysight: (1) Furnish technical information related to commercial computer software or commercial computer software documentation that is not customarily provided to the public; or (2) Relinquish to, or otherwise provide, the government rights in excess of these rights customarily provided to the public to use, modify, reproduce, release, perform, display, or disclose commercial computer software or commercial computer software documentation. No additional government requirements beyond those set forth in the EULA shall apply, except to the extent that those terms, rights, or licenses are explicitly required from all providers of commercial computer software pursuant to the FAR and the DFARS and are set forth specifically in writing elsewhere in the EULA. Keysight shall be under no obligation to update, revise or otherwise modify the Software. With respect to any technical data as defined by FAR 2.101, pursuant to FAR 12.211 and 27.404.2 and DFARS 227.7102, the U.S. government acquires no greater than Limited Rights as defined in FAR 27.401 or DFAR 227.7103-5 (c), as applicable in

any technical data. 52.227-14 (June 1987) or DFAR 252.227-7015 (b)(2) (November 1995), as applicable in any technical data.

## Safety Notices

**CAUTION.** A **CAUTION** notice denotes a hazard. It calls attention to an operating procedure, practice, or the like that, if not correctly performed or adhered to, could result in damage to the product or loss of important data. Do not proceed beyond a **CAUTION** notice until the indicated conditions are fully understood and met.

**WARNING.** A **WARNING** notice denotes a hazard. It calls attention to an operating procedure, practice, or the like that, if not correctly performed or adhered to, could result in personal injury or death. Do not proceed beyond a **WARNING** notice until the indicated conditions are fully understood and met.

# Contents

## 1 Using the Probes

Probe Features	/ 6
Oscilloscope Compatibility	/ 7
Bandwidth	/ 7
Available Accessories	/ 8
Single-Ended Measurements	/ 8
Quick-Action Button and Probe Light	/ 9
InfiniiMode Compatible	/ 9
Channel-Identification Rings	/ 9
Exchangeable Probe Tips	/ 10
To Attach a Tip	/ 11
N2776A Browser Tip	/ 12
Placing the Signal Within the Probe's Dynamic Range	/ 15
InfiniiMode	/ 16
Probe Configuration Dialog Box	/ 19
Quick-Action Button	/ 20
Probe Attenuation Ratio	/ 22
Functional Test	/ 22
Inspecting the Probe	/ 23
Cleaning the Probe	/ 23
Returning the Probe for Service	/ 24
Contacting Keysight Technologies	/ 24
Safety Information	/ 25
Instrument Markings and Safety Symbols	/ 27

<b>2</b>	<b>SPICE Models</b>	
		N2752A probe with the N2776A Browser Tip / 30
		N2750A probe with the N2777A Solder-In Tip / 33
		Measured Versus Modeled Input Impedance / 36
<b>3</b>	<b>Probe Calibration</b>	
		Calibrating the Probe / 40
<b>4</b>	<b>Characteristics and Specifications</b>	
		Dimensions / 46
<b>5</b>	<b>Performance Data Plots</b>	
		With N2776A Browser Tip (2:1 Attenuation) / 48
		With N2776A Browser Tip (10:1 Attenuation) / 52
		With N2777A Solder-In Tip (2:1 Attenuation) / 53
		With N2777A Solder-In Tip (10:1 Attenuation) / 55
		With N2778A Socketed Tip (2:1 Attenuation) / 57
		With N2778A Socketed Tip (10:1 Attenuation) / 58
<b>6</b>	<b>Performance Verification</b>	
		Test 1. DC Input Resistance / 62
		Procedure / 62
		Test 2. Bandwidth / 63
		Calibrate the Test Setup / 63
		Measure $V_{in}$ Response / 65
		Measure $V_{out}$ Response / 69
		Determine the BW / 71
		Performance Test Record / 73

# 1 Using the Probes

Probe Features	6
Exchangeable Probe Tips	10
Placing the Signal Within the Probe's Dynamic Range	15
InfiniiMode	16
Quick-Action Button	20
Probe Attenuation Ratio	22
Functional Test	22
Inspecting the Probe	23
Cleaning the Probe	23
Returning the Probe for Service	24
Safety Information	25

The N2750/1/2A differential probes can be used to perform differential, common mode, and single-ended measurements. The probes have the following bandwidths:

N2752A:	.....	.6 GHz
N2751A:	.....	3.5 GHz
N2750A:	.....	1.5 GHz

---

**CAUTION** These probes are ESD sensitive devices, particularly at the probe tips. Follow standard ESD precautions when handling. Remove tip accessories when storing the probe.

---

---

**CAUTION** Before using the probe, refer to “**Safety Information**” on page 25.

---

## Probe Features

The N2750/1/2A differential probes feature a probe Quick Action button, light, channel identification rings, and three different exchangeable snap-on probe tips: browser, solder-in, and socketed. To learn more about the probe tips, refer to **“Exchangeable Probe Tips”** on page 10. These probes use the AutoProbe oscilloscope interface for automatic configuration and power.

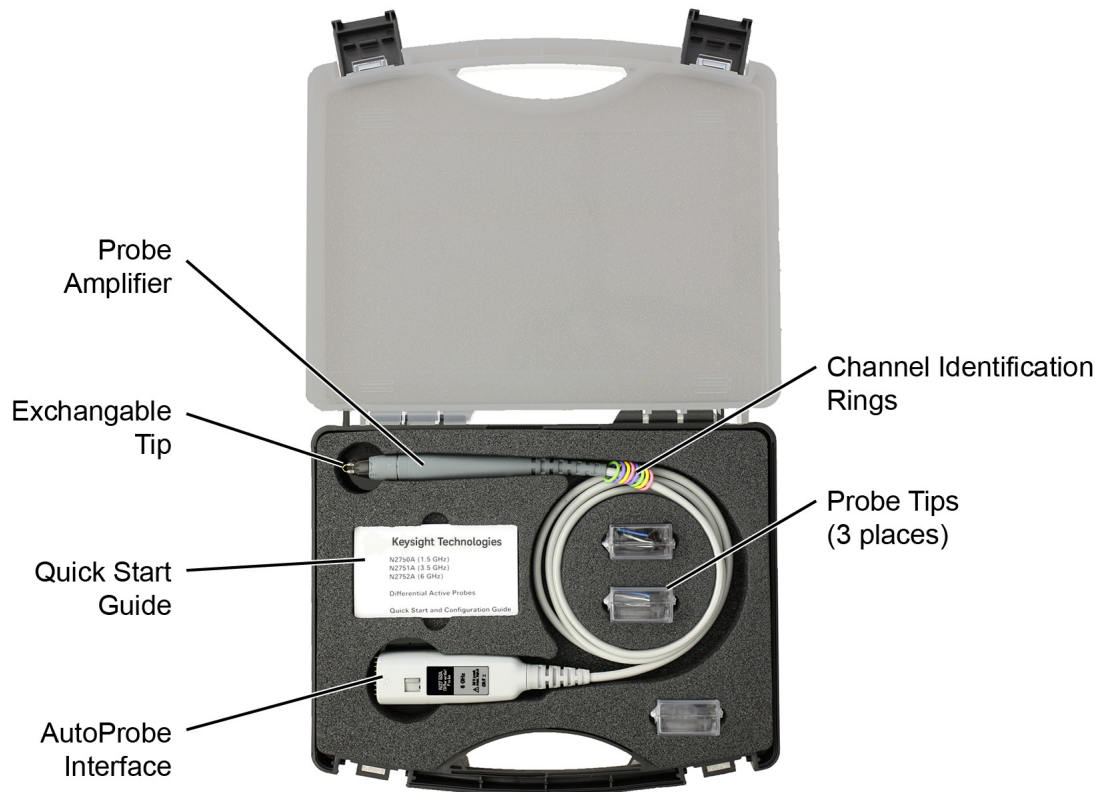

Figure 1 Probe with Supplied Accessories and Case

## Oscilloscope Compatibility

The probes are compatible with 9000 Series, 90000 Series, or 90000 Q/X-Series Infiniium oscilloscopes with software version 3.50 or above. Infiniium 90000 Q/X-Series requires the N5442A adapter. The probes are compatible with 3000X-series InfiniiVision oscilloscopes (one probe maximum connected to oscilloscope). The probes are also compatible with 4000X-series InfiniiVision oscilloscopes (up to four probes connected to oscilloscope).

## Bandwidth

As shown in the following table, the available probe bandwidth depends on the probe model, attached probe tip, and type of signal probed. To learn about the supplied probe tips, refer to “[Exchangeable Probe Tips](#)” on page 10.



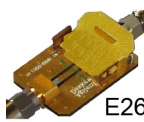

**Table 1** Available Probe Bandwidth

Signal Type	Browser Probe Tip	Socketed Probe Tip	Solder-In Probe Tip
<b>N2752A 6 GHz at 2:1 / 10:1</b>			
Differential	6 GHz <i>(7 GHz typical)</i>	3 GHz	2.5 GHz
Single-Ended	6 GHz <i>(7 GHz typical)</i>	1.2 GHz	2 GHz
Common-Mode	N/A	1 GHz	1.4 GHz
<b>N2751A 3.5 GHz at 2:1 / 10:1</b>			
Differential	3.5 GHz	3 GHz	2.5 GHz
Single-Ended	3.5 GHz	1.2 GHz	2 GHz
Common-Mode	N/A	1 GHz	1.4 GHz
<b>N2750A 1.5 GHz at 2:1 / 10:1</b>			
Differential	1.5 GHz	1.5 GHz	1.5 GHz
Single-Ended	1.5 GHz	1.2 GHz	1.5 GHz
Common-Mode	N/A	1 GHz	1.4 GHz

## Available Accessories

The following table shows the accessories that are available for use with the probes.

**Table 2** Available Accessories

Model Number	Accessory	
N5442A	Precision BNC adapter for use with 90000 Q/X-Series oscilloscopes	
N2787A	3D probe positioner	
E2655B/C or N5443A	Performance verification and deskew fixture. The PV fixture is used in <a href="#">Chapter 3</a> , “Probe Calibration” and <a href="#">Chapter 6</a> , “Performance Verification”.	 

## Single-Ended Measurements

You can use the differential probes to make single-ended measurements by touching one probe tip to the ground on the device being tested. In fact, using these differential probes in any situation where a single-ended probe would traditionally be used results in higher Common Mode Rejection Ratio (CMRR), increased signal fidelity (due to very low impedance grounding and higher input impedance), and decreased probe response variations (better repeatability).



## Quick-Action Button and Probe Light

Press the quick-action button to turn the probe light on and off. Pressing and holding the button will increase and decrease the light's intensity. Using the oscilloscope's Probe Configuration dialog box, you can re-assign the button's function. Refer to **“Quick-Action Button”** on page 20.

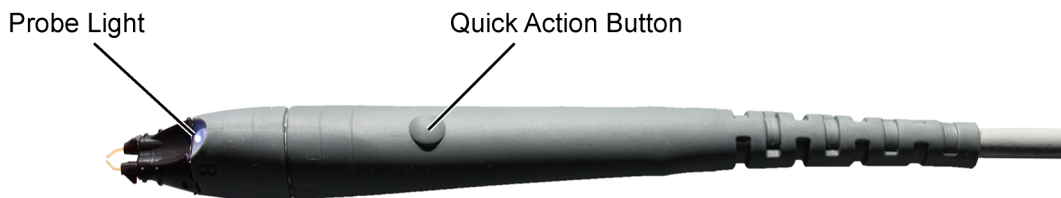

Figure 2 Location of Button and Light

## InfiniiMode Compatible

The probes, when fitted with the socketed or solder-in tip, are InfiniiMode compatible. InfiniiMode allows you to switch between differential, single-ended, and common mode measurements without needing to change or reconnect the probe or probe leads. To learn about this feature, refer to **“InfiniiMode”** on page 16.

## Channel-Identification Rings

When multiple probes are connected to the oscilloscope, the channel identification rings allow you to quickly determine which channel input is associated with each probe. On the probe, place one colored ring near the probe's channel connector and place an identical color ring near the probe head.



**CAUTION** Handle the probe cable carefully to avoid damaging it through excessive bending or pulling. Avoid any mechanical shocks to the probe in order to guarantee accurate performance and protection.

## Exchangeable Probe Tips

The probe comes with three unique tips for different probing situations. They are the browser, solder-in, and socketed tips as shown in **Table 3** and described later in this section. For information on using the solder-in and socketed tips with InfiniiMode, refer to “**InfiniiMode**” on page 16.

The tip’s symmetrical design allows you to orient the tip so that either lead (for example, the blue lead on N2777A and N2778A tips) can be associated with the probe’s A or B sides. Refer to “**InfiniiMode**” on page 16 for the significance of the A and B leads in differential measurements.

**Table 3** Supplied Probe Tips

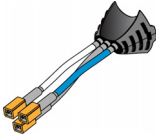
Tip	Quantity	Replacement Tip Kit
 Differential Browser Tip (adjustable span) described on <a href="#">page 12</a> .	2	N2776A (includes three browser tips)
 InfiniiMode Solder-In Tip described on <a href="#">page 13</a> .	2	N2777A (includes three solder-in tips)
 InfiniiMode Socketed Tip described on <a href="#">page 14</a> .	2	N2778A (includes three socketed tips)

## To Remove a Tip

Hold the probe in one hand while holding the body of the tip in the other hand. Gently pull the probe tip straight off the probe.

**CAUTION** Do not remove the tip by pulling on the tip leads.



Figure 3 Do not pull on the tip leads

## To Attach a Tip

- 1 Orient the new tip as shown in the following figure. For solder-in and socketed tips, you can orient the tip such that the blue lead is labeled lead **A** or **B**.
- 2 Gently press the tip onto the probe. Never apply excessive force when attaching the tip.

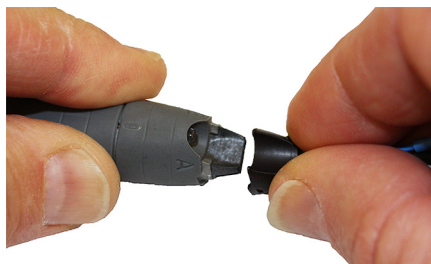

Figure 4 Aligning the Tip to the Probe

## N2776A Browser Tip

The N2776A browser tip allows you to quickly probe the different points in your device. The tip includes integrated damping resistors. To adjust the tip spacing, turn the handles that are located on the tip ends as shown in **Figure 5**. Spacing can range between 0.5 mm and 7.5 mm.

The probes have the following bandwidths when using these tips:

N2752A Probe Amplifier: . . . . .6 GHz

N2751A Probe Amplifier: . . . . .3.5 GHz

N2750A Probe Amplifier: . . . . .1.5 GHz

As the N2776A browser tip can only be used in differential mode, it is not compatible with InfiniiMode.

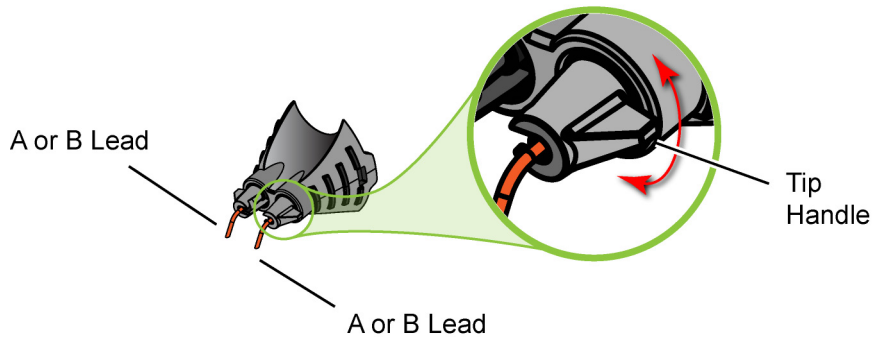

Figure 5 Browser Tip with Spacing Adjustment

## N2777A Solder-In Tip

The N2777A solder-in tip is intended to be soldered directly to your test device. The tip includes integrated damping resistors. For best performance, use this tip in differential mode with inputs A and B connected to test nodes.

The probes have the following bandwidths when using this tip:

N2752A Probe Amplifier: . . . . . 2.5 GHz

N2751A Probe Amplifier: . . . . . 2.5 GHz

N2750A Probe Amplifier: . . . . . 1.5 GHz

When installing the tip on the probe, the tip's symmetrical design allows you to orient the tip so that the blue lead can be located on the probe's A or B side.

---

**NOTE** The color and position of the leads is not important except to allow you to easily distinguish between the **A** and **B** leads.

---

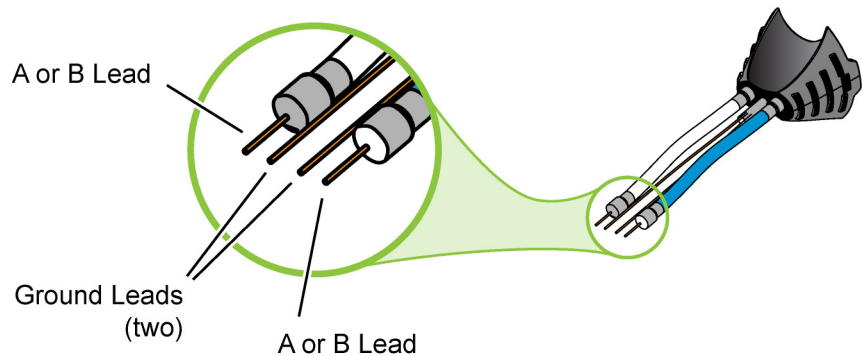

Figure 6 Solder-In Tip

## N2778A Socketed Tip

Use the N2778A socketed tip for connecting the probe directly to 0.25-inch header pins. For best performance, use this tip in differential mode with inputs A and B connected to test nodes. The socketed leads include a damping resistor.

The probes have the following bandwidths when using this tip:

N2752A Probe Amplifier: . . . . .3 GHz

N2751A Probe Amplifier: . . . . .3 GHz

N2750A Probe Amplifier: . . . . .1.5 GHz

When installing the tip on the probe, the tip's symmetrical design allows you to orient the tip so that the blue lead can be located on the probe's A or B side.

---

**NOTE** The color and position of the leads is not important except to allow you to easily distinguish between the **A** and **B** leads.

---

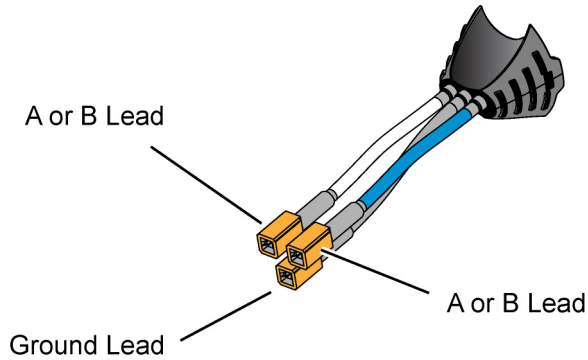
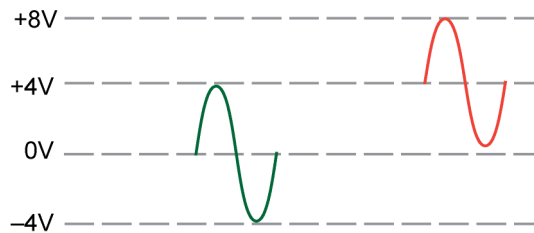

Figure 7 Socketed Tip

## Placing the Signal Within the Probe's Dynamic Range

When making single-ended or common mode measurements, you can apply vertical offset to place the signal within the probe's dynamic range. Vertical offset centers a signal at 0V on the oscilloscope's display by compensating for the signal's DC component. The red signal in **Figure 8** has a +4V DC component. The green signal show the result of applying -4V vertical offset.



**Figure 8** Vertical Offset Applied to an Input Signal

---

**NOTE** The above figure uses an example offset of -4V. The actual available range is dependent on the oscilloscope. Refer to the oscilloscope's vertical offset specification that is located in the help system.

---

## InfiniiMode

The probes, when fitted with a socketed or solder-in tip, are InfiniiMode compatible. InfiniiMode allows you to switch between differential, single-ended, and common mode measurements without needing to change or reconnect the probe or probe leads. The following table shows, depending on the probe tip and InfiniiMode setting, which signal types can be measured.

**Table 4** Supported InfiniiMode Measurements by Probe Tip

InfiniiMode Setting	Signal Being Measured	
	Single-Ended	Differential
Differential	Browser ( <i>full BW</i> ) <sup>a</sup>	Browser ( <i>full BW</i> )
	Solder-In ( <i>lower BW</i> )	Solder-In ( <i>lower BW</i> )
	Socketed ( <i>lower BW</i> )	Socketed ( <i>lower BW</i> )
Single-Ended	Browser ( <i>not supported</i> )	Browser ( <i>not supported</i> )
	Solder-In	Solder-In
	Socketed	Socketed
Common-Mode	Browser ( <i>not supported</i> )	Browser ( <i>not supported</i> )
	Solder-In	Solder-In
	Socketed	Socketed

<sup>a</sup> Full bandwidth obtained by touching one tip to ground.

---

**NOTE** Because the N2776A browser tip has two leads instead of three, it is not InfiniiMode compatible. However, you can still use the browser tip to measure single-ended signals by selecting differential mode and touching one tip to ground.

---



## Making InfiniiMode Connections

When probing a differential or common mode signal, connect the probe tips as shown in the example circuit of **Figure 9**. Notice that the sides of the probe are marked **A** and **B** to identify the two signal leads.

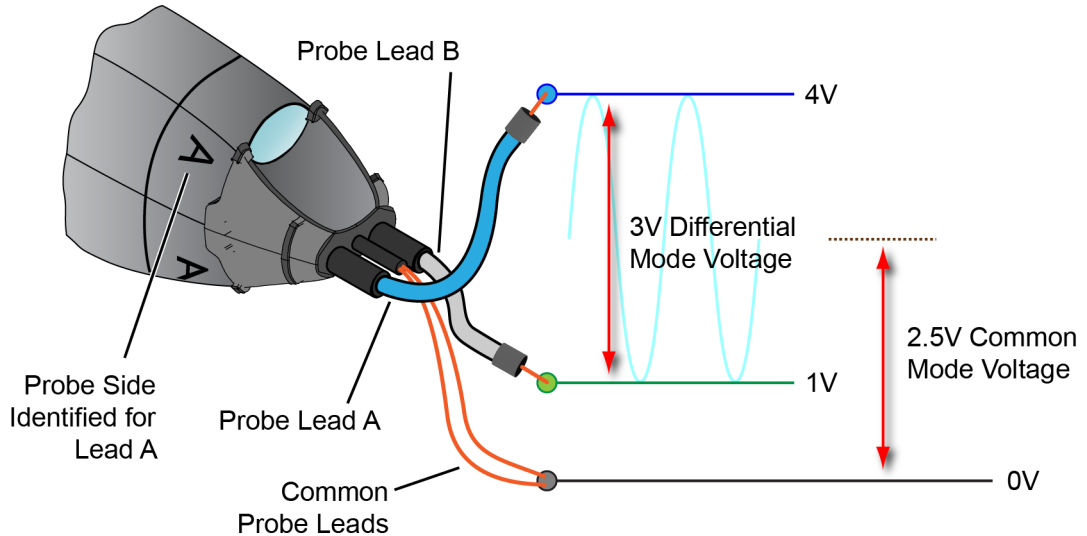

Figure 9 Example InfiniiMode Probe Circuit Connections

**NOTE** The lead's color allows you to easily distinguish between the **A** and **B** leads. **Figure 9** shows the blue lead oriented so that it is lead **A**. The tip could easily be removed and rotated 180° so that the blue lead becomes the **B** lead.

The following measurements can be made *without* reconnecting the probe tips. In the equations, the **A** and **B** variables represent the signal from the A and B probe leads.



Figure 10 Lead Identification on Probe Body

#### Differential

$$A - B = 4V - 1V = 3V$$

#### Common Mode

$$\frac{A + B}{2} = \frac{4V + 1V}{2} = 2.5V$$

#### Single-Ended A

$$A - \text{gnd} = 4V - 0V = 4V$$

#### Single-Ended B

$$B - \text{gnd} = 1V - 0V = 1V$$

## Probe Configuration Dialog Box

When the probe is connected to an Infiniium oscilloscope (9000 Series, 90000 Series, or 90000 Q/X-Series), the Probe Configuration dialog box automatically opens as shown in **Figure 11**. The oscilloscope automatically detects the signal type, which is indicated in the dialog box.

In the dialog box's InfiniiMode field, select the measurement mode: **Differential**, **Single-Ended A**, **Single-Ended B**, or **Common Mode**. The default setting is **Differential**.

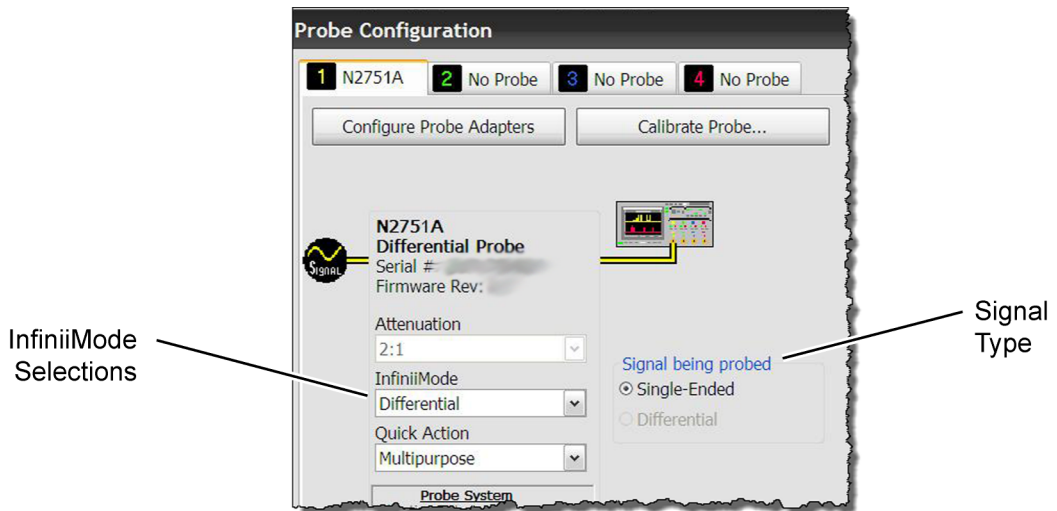

Figure 11 Probe Configuration Dialog Box

---

**NOTE** You can also open this dialog box by clicking **Utilities > Probe Configuration**.

---



---

**NOTE** The probes have a 2 GHz bandwidth when used with InfiniiMode.

---

## Quick-Action Button

By default, the probe's quick-action button turns the probe light on and off. However, you can reassign this button to another function by using the oscilloscope's Probe Configuration dialog box.

**NOTE** Requires a 9000 Series, 90000 Series, or 90000 Q/X-Series Infiniium oscilloscope with software version 3.50 or above.

To reassign the probe button, click **Utilities > Probe Configuration**. In the Probe Configuration dialog box, click the tab for the N2750A, N2751A, or N2752A probe and then select the desired action in the Quick Action field.

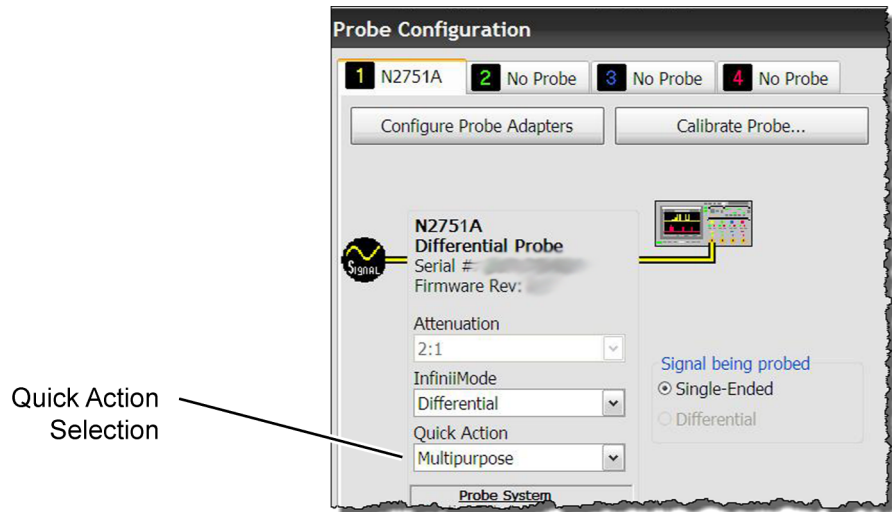

Figure 12 Probe Configuration Dialog Box

## Quick Action Selections

You can select one of the following probe button Quick Actions.

### **Toggle Headlight**

Turns the probe light on and off. This is the default button configuration.

### **Adjust Headlight Intensity**

Hold the button down, and the light's intensity increases and decreases.

### **Run/Stop**

Toggles between continuous data acquisition and stopping data acquisition.

### **Single**

Initiates a single data acquisition.

### **Clear Display**

Clears the current data from the display.

### **Autoscale**

Performs an autoscale of the displayed waveform.

### **Multipurpose**

Assigns the currently configured Multipurpose function to the probe button. To select from among the following Multipurpose functions, click **Utilities > Customize Multipurpose**:

- ? QuickMeas
- ? QuickPrint
- ? QuickScreen
- ? QuickSetup
- ? QuickWaveform
- ? QuickEmail
- ? QuickExecute
- ? QuickControl

Refer to the oscilloscope's online help for information on Multipurpose functions.

### No Action

Disables the probe button.

## Probe Attenuation Ratio

The probe's attenuation ratio can be set to 2:1 or 10:1. When you attach the probe to the Infiniium oscilloscope, the AutoProbe interface automatically sets the probe attenuation to the value necessary to make the dynamic range of the probe greater or equal to the level required to measure the current input signal.

## Functional Test

Use the following generic measurement procedure to ensure that your probe is functioning properly.

- 1 Connect the probe to an oscilloscope channel input and ensure the input impedance of the oscilloscope matches the output impedance of the probe (50 $\Omega$ ).
- 2 On the oscilloscope, click **Utilities > Calibration Output** to assign probe compensation (Probe Comp) to the **AUX Output** connector.
- 3 Connect the probe tip to the oscilloscope's front-panel **AUX Output** connector.
- 4 Press the oscilloscope's **[Auto Scale]** button.
- 5 If the probe is functioning properly, a square wave should now be displayed on the oscilloscope.

## Inspecting the Probe

- Inspect the shipping container for damage.  
Keep the damaged shipping container or cushioning material until the contents of the shipment have been checked for completeness and the probe has been checked mechanically and electrically.
- Check the accessories.
- If the contents are incomplete or damaged, notify your Keysight Technologies Sales Office.
- Inspect the probe.

If there is mechanical damage or defect, or if the probe does not operate properly or pass calibration tests, notify your Keysight Technologies Sales Office.

If the shipping container is damaged, or the cushioning materials show signs of stress, notify the carrier as well as the sales office. Keep the shipping materials for the carrier's inspection. The sales office will arrange for repair or replacement at Keysight Technologies' option without waiting for claim settlement.

## Cleaning the Probe

Disconnect the probe from the oscilloscope and clean the probe with a soft cloth dampened with a mild soap and water solution. Make sure the probe is completely dry before reconnecting it to an oscilloscope.

## Returning the Probe for Service

If the probe is found to be defective we recommend sending it to an authorized service center for all repair and calibration needs. Perform the following steps before shipping the probe back to Keysight Technologies for service.

- 1** Contact your nearest Keysight sales office for information on obtaining an RMA number and return address.
- 2** Write the following information on a tag and attach it to the malfunctioning equipment.
  - Name and address of owner
  - Product model number (for example, N2751A)
  - Product Serial Number (for example, MYXXXXXXXX)
  - Description of failure or service required

---

**NOTE** Include probing and browsing tips if you feel the probe is not meeting performance specifications or a yearly calibration is requested.

---

- 3** Protect the probe by wrapping in plastic or heavy paper.
- 4** Pack the probe in the original carrying case or if not available use bubble wrap or packing peanuts.
- 5** Place securely in sealed shipping container and mark container as "FRAGILE".

---

**NOTE** If any correspondence is required, refer to the product by serial number and model number.

---

## Contacting Keysight Technologies

For technical assistance, contact your local Keysight Call Center.

- In the Americas, call 1 (800) 829-4444
- In other regions, visit <http://www.keysight.com/find/assist>

Before returning an instrument for service, you must first call the Call Center at 1 (800) 829-4444.



## Safety Information

To avoid personal injury and to prevent fire or damage to this product or products connected to it, review and comply with the following safety precautions. Be aware that if you use this probe assembly in a manner not specified, the protection this product provides may be impaired.

---

**WARNING** **Handle Probe Tips and Accessories Carefully.**  
Some of the probe tips and accessories are very sharp (the browser tips, for example). You should handle these with care to avoid personal injury.

---

**WARNING** **Use Only Grounded Instruments.**  
Do not connect the probe's ground lead to a potential other than earth ground. Always make sure the probe and the oscilloscope are grounded properly.

---

**WARNING** **Connect and Disconnect Properly.**  
Connect the probe to the oscilloscope and connect the ground lead to earth ground before connecting the probe to the circuit under test. Disconnect the probe input and the probe ground lead from the circuit under test before disconnecting the probe from the oscilloscope.

---

**WARNING** **Observe Probe Ratings.**  
Do not apply any electrical potential to the probe input which exceeds the maximum rating of the probe. Make sure to comply with the voltage versus frequency derating curve found in this manual.  
These probes are for use only on circuits that are NOT directly connected to mains. These are NOT intended for measurements on CAT II, CAT III, or CAT IV circuits.

---

**WARNING** **Keep Away From Live Circuits.**  
Avoid open circuitry. Do not touch connections or components when power is present.

---

**WARNING** **Indoor Use Only.**  
Do not operate in wet/damp environments. Keep product surfaces dry and clean.

---

---







**CAUTION** The probe cable is a sensitive part of the probe and, therefore, you should be careful not to damage it through excessive bending or pulling. Avoid any mechanical shocks to this product in order to guarantee accurate performance and protection.

---

**CAUTION** Periodically inspect the probe and probe wires to check for any damage. Do Not Operate With Visible or Suspected Failures. If you suspect there is damage, have it inspected by a Keysight authorized service personnel.

---

## Instrument Markings and Safety Symbols

Symbol	Description
	STANDBY and AC symbols. The STANDBY marks the position of the instrument power line switch. The AC symbol is used to indicate the required nature of the line module input power.
	The CE mark is a registered trademark of the European Community. ISM GRP 1-A denotes the instrument is an Industrial Scientific and Medical Group 1 Class A product. ICES/NMB-001 indicates product compliance with the Canadian Interference-Causing Equipment Standard.
	The CSA mark is a registered trademark of the Canadian Standards Association.
	The C-Tick mark is a registered trademark of the Australian Spectrum Management Agency.
	This product complies with the WEEE Directive (2002/96/EC) marking requirements. The affixed label indicates that you must not discard this electrical/electronic product in domestic household waste. Product Category: With reference to the equipment types in the WEEE Directive Annex I, this product is classed as a “Monitoring and Control instrumentation” product. Do not dispose in domestic household. To return unwanted products, contact your local Keysight office, or refer to <a href="http://www.keysight.com">www.keysight.com</a> for more information.
	This symbol indicates the Environmental Protection Use Period (EPUP) for the product's toxic substances for the China RoHS requirements.
	Recycle marking.

## 1 Using the Probes

## 2 SPICE Models

N2752A probe with the N2776A Browser Tip	30
N2750A probe with the N2777A Solder-In Tip	33

This chapter presents input impedance SPICE models for the combinations of N2752A probe with N2776A Browser tip and N2750A probe with N2777A solder-in tip. SPICE sub-circuit file listings are provided so that you can copy and paste the data into your SPICE simulations.

## N2752A probe with the N2776A Browser Tip

The following SPICE RLC circuit models the input impedance of the N2752A and N2776A combination. See [Figure 14](#) on page 32 to view the matching between the measured and modeled input impedance.

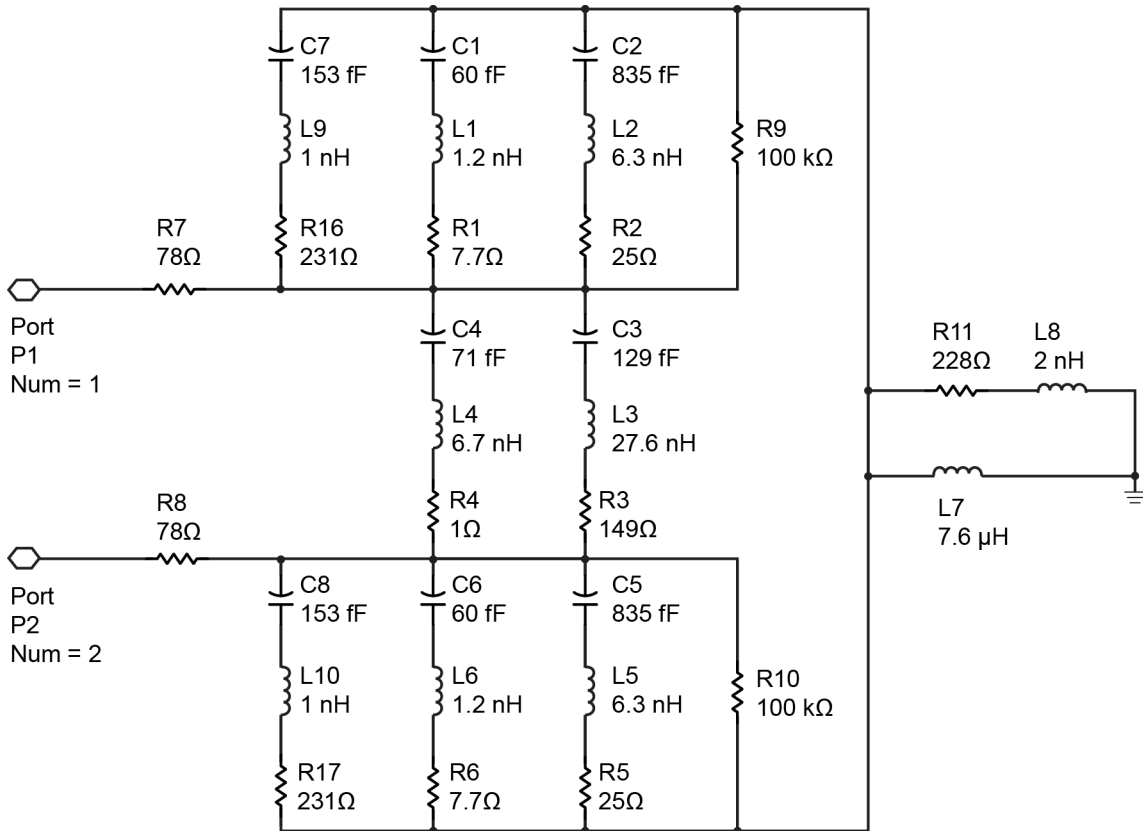

Figure 13 SPICE Model

## SPICE Data

Copy and paste the following lines of data into your SPICE simulations.

```
.subckt N2750_Browser 1 2
C7 15 5 153f
L9 5 4 1n
R16 4 3 231
C1 15 8 60f
C2 15 10 835f
L1 8 7 1.2n
L2 10 9 6.3n
R1 7 3 7.7
R2 9 3 25
C4 3 20 71f
L4 20 21 6.7n
R4 21 12 1
C3 3 22 129f
L3 22 23 27.6n
R3 23 12 149
C6 12 16 60f
L6 16 17 1.2n
R6 17 15 7.7
C8 12 13 153f
L10 13 14 1n
R17 14 15 231
C5 12 18 835f
L5 18 19 6.3n
R5 19 15 25
R7 3 1 78
R8 12 2 78
R11 11 15 228
L8 11 0 2n
L7 15 0 7.6μ
R9 15 3 100k
R10 12 15 100k
.end
```

## Measured Versus Modeled Input Impedance

The following plot shows how well the modeled impedance tracks the measured impedance.

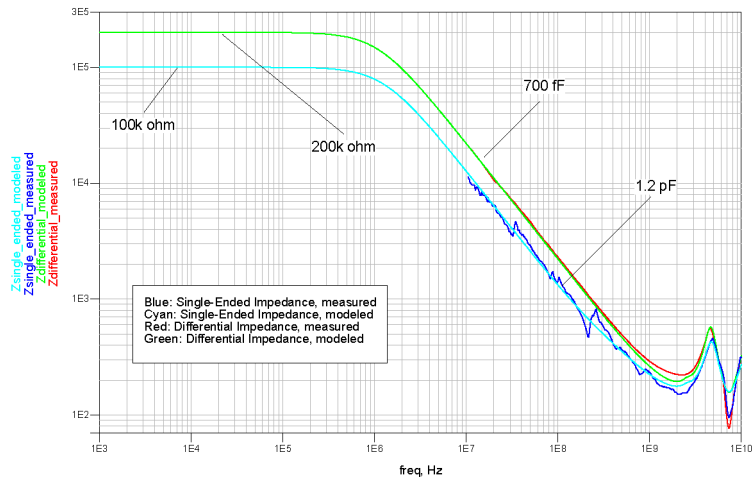

Figure 14 Input Impedance, Measured and Modeled (Differential)



## N2750A probe with the N2777A Solder-In Tip

The following SPICE RLC circuit models the input impedance of the N2750A and N2777A combination. Observe the following items when positioning the tip wires:

- It is assumed that the tip wires are approximately parallel and connected to the target at approximately 100 mils spacing.
- As shown in **Figure 15**, the tip wires are assumed to be kept roughly parallel from the N2750A probe to the solder-in point. Dramatically spreading the tip wires to cover a large span, significantly alters the input model and a new model would be needed.
- Pin 1 is the + input, pin 2 is the – input and pin 3 is the ground connection.
- The impedance is *not* a strong function of the orientation of the tip wires (for example, vertical or flat) as long as, when flat, the tip wires are not positioned down on the ground plane surface.

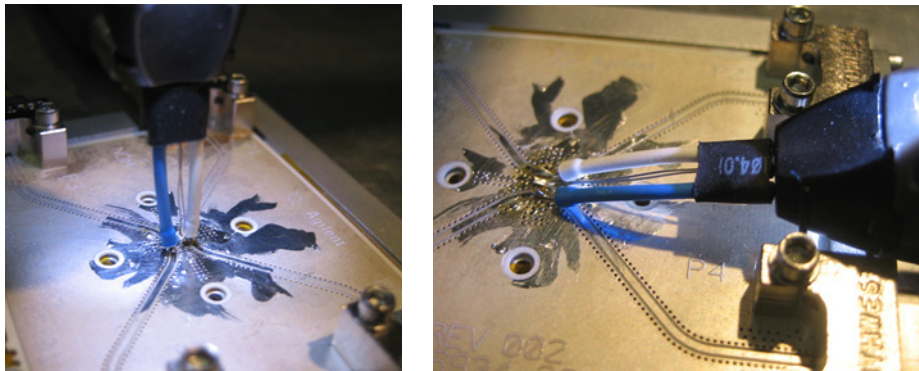
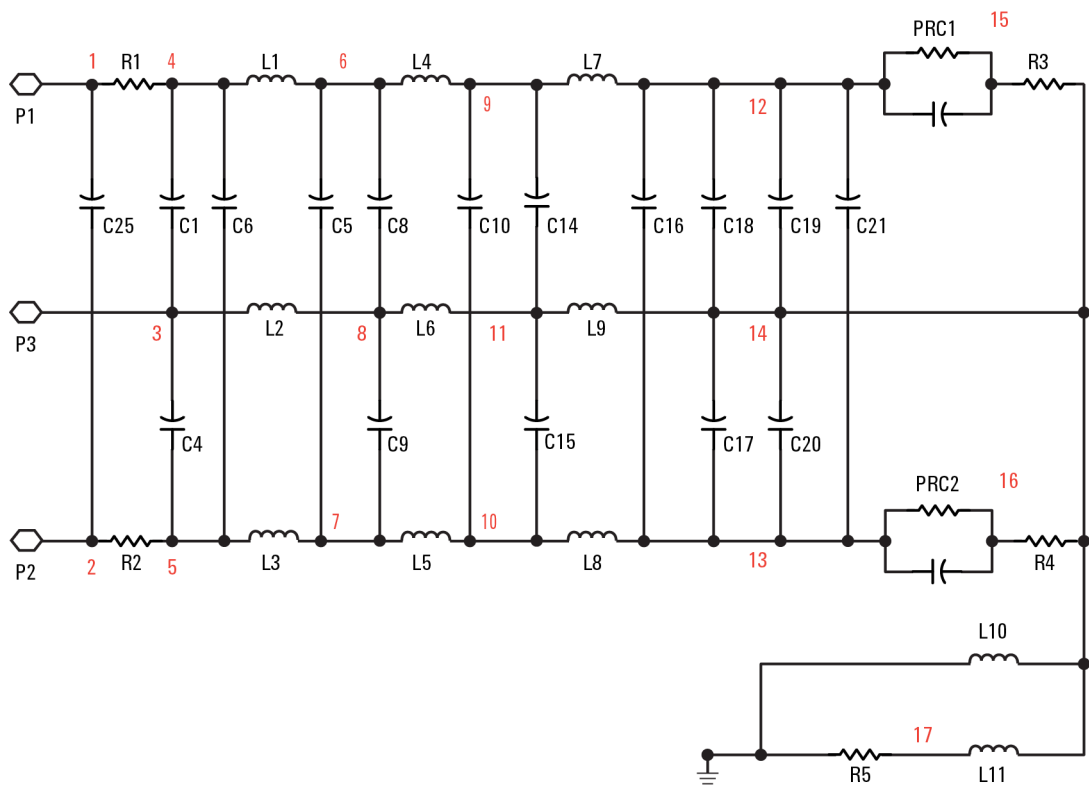

Figure 15 Nominal Connections

---

NOTE Do not infer any transfer function accuracy from this model.

---



This model should be viewed as a black box model. While it is somewhat physically based, the response has been optimized so it accurately reflects the port impedances so component values may not agree totally with the actual physical implementation.

Figure 16 SPICE Model

## SPICE Data

Copy and paste the following lines of data into your SPICE simulation deck.

```
.subckt N2777A_N2750A_InputZ 1 2 3
C25 1 2 53.7f
R1 1 4 129.3
R2 2 5 129.3
C1 4 3 82.1f
c4 3 5 82.1f
c6 4 5 1.965f
l1 4 6 5.14n
l3 5 7 5.14n
l2 3 8 5.82n
c5 6 7 3.929f
c8 6 8 164.2f
c9 8 7 164.2f
l4 6 9 5.14n
l5 7 10 5.14n
l6 8 11 5.82n
c10 9 10 3.929f
c14 9 11 164.2f
c15 11 10 164.2f
l7 9 12 5.14n
l8 10 13 5.14n
l9 11 14 5.82n
c16 12 13 1.965f
c18 12 14 82.1f
c17 14 13 82.1f
c19 12 14 655f
c20 13 14 655f
c21 12 13 40f
rprc1 15 12 100k
cprc1 15 12 300f
rprc2 16 13 100k
cprc2 16 13 300f
r3 14 15 50
r4 14 16 50
l10 0 14 30u
l11 17 14 2n
r5 0 17 250
k6 11 12 .3794
k5 11 13 .0954
k4 12 13 .3794
```

```

k9 14 16 .3794
k8 14 15 .0954
k7 16 15 .3794
k12 17 19 .3794
k11 17 18 .0954
k10 19 18 .3794
.ends

```

## Measured Versus Modeled Input Impedance

The following plots show how well the modeled impedance tracks the measured impedance. The model agrees very well out to approximately 5 GHz. Above 5 GHz, the single-ended and differential models are fairly accurate but the common mode model degrades because of outside mode uncertainties.

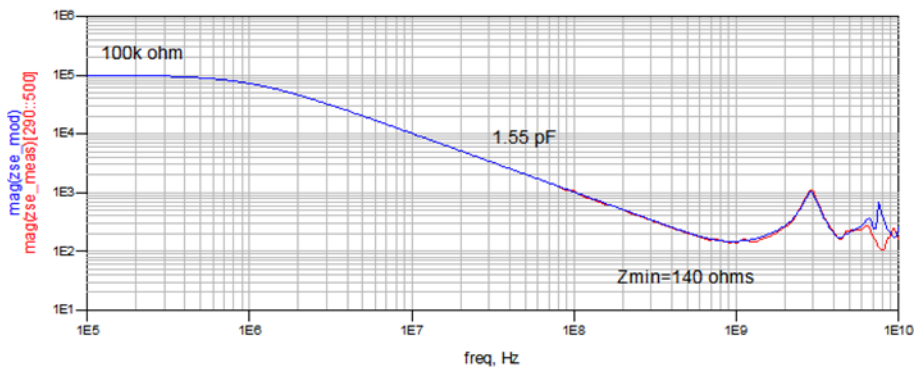

Figure 17 Single-Ended Input Impedance (Measured, Modeled)

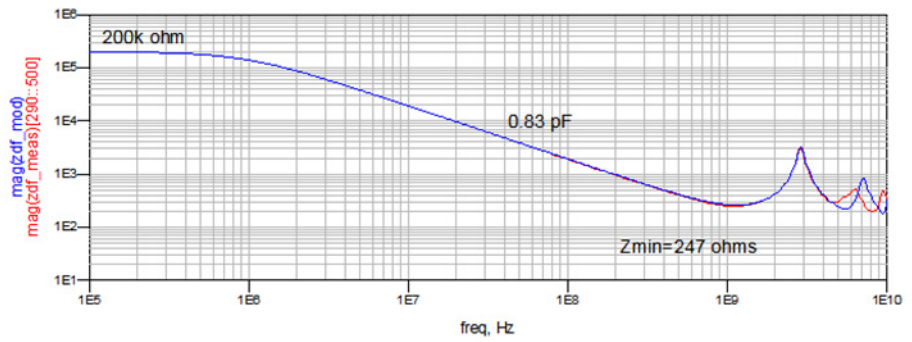

Figure 18 Differential Input Impedance (Measured, Modeled)

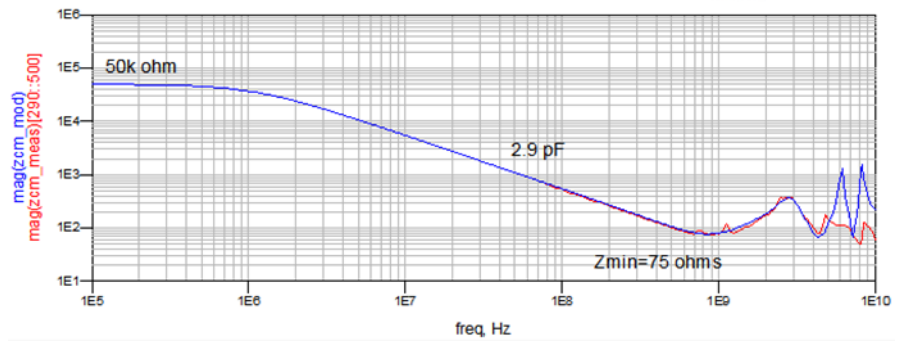

Figure 19 Common Mode Input Impedance (Measured, Modeled)



## 3 Probe Calibration

Always calibrate the probe before making any critical measurements. A probe calibration removes attenuation errors, offset errors, and timing delays that are introduced by the probe. Additional information on the probe calibration procedure is located in the oscilloscope's online help.

Probe calibrations vary slightly between 9000 Series, 90000 Series, and 90000 Q/X-Series oscilloscopes. For 9000 Series oscilloscopes, the following calibrations are used:

- Skew Calibration
- Attenuation/Offset Calibration

For 90000 Series oscilloscopes, the following calibrations are used:

- DC Attenuation/Offset Calibration
- Skew Calibration
- AC Response Calibration

---

**NOTE** When performing the attenuation and offset calibrations, the probe is not connected to any signal sources. During the skew calibration, the probe is connected to the oscilloscope's calibration output signal via a PV fixture.

---

When performing the skew calibration and AC Response calibration, the E2655B or N5443A Performance Verification (PV) and deskew fixture is used. The PV fixture is included with the Deskew Kit which is shipped with Infiniium oscilloscopes. The fixture is also used in the performance verification procedure that is documented in [Chapter 6](#), "Performance Verification".

An optional N2787A 3D Probe Positioner or equivalent can be used to hold the probe during the calibration.



---

**CAUTION** Always wear an ESD wrist strap when working with active probes. Not doing so can result in the probe becoming permanently damaged.

---

## Calibrating the Probe

- 1 Turn on the oscilloscope. Allow the oscilloscope and probe to warm up for 20 minutes before performing the probe calibrations.
- 2 If the oscilloscope needs calibration, perform a user calibration before the probe calibration. On the oscilloscope, click **Utilities > Calibration**.
- 3 On the oscilloscope, click **Setup > Probes**.
- 4 In the Probe Calibration dialog box, select the tab representing the channel that has the probe attached.
- 5 In the dialog box, select the probe head and the type of calibration. Click **Start** and follow the instructions shown on the oscilloscope.
- 6 When performing the skew calibration, you will be instructed to use the PV fixture. Observe these points:
  - Connect the PV fixture's input to the oscilloscope's calibration output. Connect a 50 ohm terminator to the PV's output as shown in **Figure 20**.

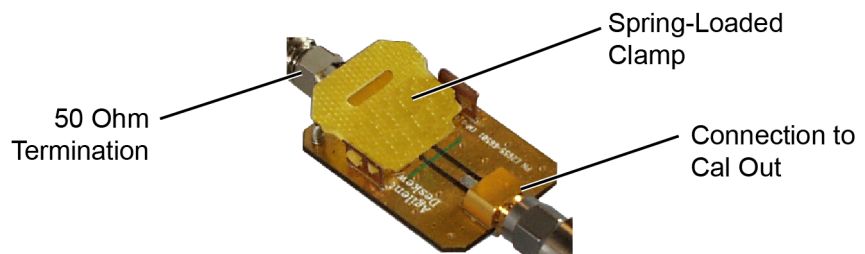

Figure 20 E2655B PV Fixture with 50 Ohm Termination



- Clamp the probe leads to the PV fixture's signal or ground. Position the probe tips on the PV fixture as shown in **Figure 21**. When using the solder-in tip, use the fixture's spring-loaded clamps to hold the leads.

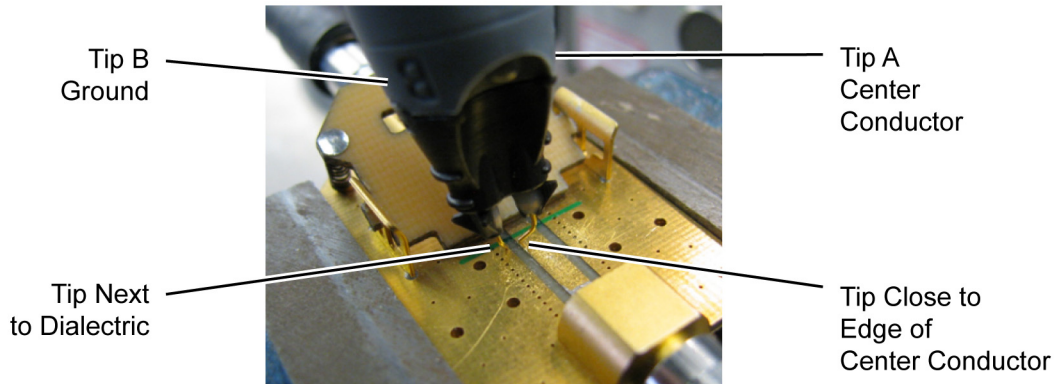

Figure 21 Example of Proper Lead Placement on an E2655B PV Fixture (Browser Tip Shown)

- On 90000 Q/X-Series oscilloscopes, use an N5442A adapter when instructed to connect the probe to one of the oscilloscope's channel inputs.

**CAUTION** To avoid damaging the oscilloscope's **Cal Out** connector, do not apply force to the PV fixture. Light probe contact is all that is needed for the calibration.

**CAUTION** NEVER solder a probe tip to the thick-film gold. The gold will immediately dissolve into the solder and disappear.

**NOTE** If you are using the browser tip, it is recommended that you use the N2787A 3D Probe Positioner to hold the probe in place.

**NOTE** You can check that the probe leads are correctly connected by pressing the front panel autoscale button. A stable step should be shown on the screen. Pressing autoscale will close the Probe Calibration dialog box.

### 3 Probe Calibration

# 4 Characteristics and Specifications

This chapter provides the characteristics and specifications for the N2750/1/2A differential active probes. The probe and oscilloscope should be warmed up for at least 20 minutes before any testing and the environmental conditions should not exceed the probe's specified limits.

**Table 5** Electrical Characteristics and Specifications (Sheet 1 of 2)

Model Number	N2750A	N2751A	N2752A
Probe Bandwidth (-3 dB) <sup>a</sup>	1.5 GHz	3.5 GHz	6 GHz (warranted), 7 GHz (typical)
Rise time, probe only (10 – 90%)	233 ps	100 ps	58.3 ps
System Bandwidth (with Keysight oscilloscope)	1 GHz (with Keysight's 1 GHz Infiniium oscilloscope)	2.5 GHz (with Keysight's 2.5 GHz Infiniium oscilloscope)	4/6 GHz (with Keysight's 4/6 GHz Infiniium oscilloscope)
Input Resistance (at DC) <sup>a</sup>	200 k $\Omega$ $\pm$ 2% (differential mode) 100 k $\Omega$ $\pm$ 2% (single-ended mode) 50 k $\Omega$ $\pm$ 2% (common mode)		
Input Capacitance	700 fF (with browser)		
Attenuation Ratio (at DC)	2:1 / 10:1		
Input Dynamic Range	$\pm$ 1Vdc, 2Vpp (@ 2:1) mains isolated $\pm$ 5Vdc, 10Vpp (@ 10:1) mains isolated		
Input Common-Mode Range	$\pm$ 15V (dc to 100 Hz) $\pm$ 2.5V (>100 Hz) <sup>b</sup>		
Offset Range	$\pm$ 15V		
Offset Accuracy <sup>c</sup>	< 3% (characteristic)		
Maximum Non-Destructive Input Voltage	$\pm$ 30V (DC + peak AC) mains isolated		
Common Mode Rejection Ratio	60 dB at 1 MHz 50 dB at 30 MHz 30 dB at 1 GHz		
Differential Mode Rejection Ratio	50 dB at 1 MHz 50 dB at 30 MHz 40 dB at 1 GHz		
Channel Isolation, at single-ended mode	60 dB at 1 MHz 45 dB at 30 MHz 20 dB at 1 GHz		
Offset Gain Accuracy	< 3% before calibration < 1% after calibration		
Noise Referred to Input	2.5 mV <sub>rms</sub> (at 2:1) 7 mV <sub>rms</sub> (at 10:1)		

**Table 5** Electrical Characteristics and Specifications (Sheet 2 of 2)

Model Number	N2750A	N2751A	N2752A
Maximum Signal Slew Rate	30V/ns (differential, 10:1) 15V/ns (single-ended, 10:1)		
Zero Offset Error Referred to Input	< 30 mV before calibration scope < 5 mV after calibration scope		
Propagation Delay	6.85 ns		
ESD Tolerance	> 8 kV from 100 pF, 300Ω, HBM		
Output Impedance	50Ω		
Cable Length	1.3m		
Probe Weight	100g		
Ambient Operating Temperature	0°C to +40°C		
Ambient Non-Operating Temperature	-40°C to +70°C		
Operating Humidity	Up to 95% relative humidity at +40°C non-condensing		
Non-Operating Humidity	Up to 90% relative humidity at +65°C non-condensing		
Operating Altitude	4,600m		
Non-Operating Altitude	15,300m		
EMC/EMI	Radiated Emission: CISPER 11 Group 1, Class A. ESD: IEC61000-4-2 4KV Contact discharge, 8KV Air discharge		

- a Denotes warranted electrical specifications at 2:1 attenuation mode after 20 minute warm-up. All others are typical.
- b Assumes symmetric differential signals.
- c When calibrated on the oscilloscope, these characteristics are determined by the oscilloscope characteristics.

## Dimensions

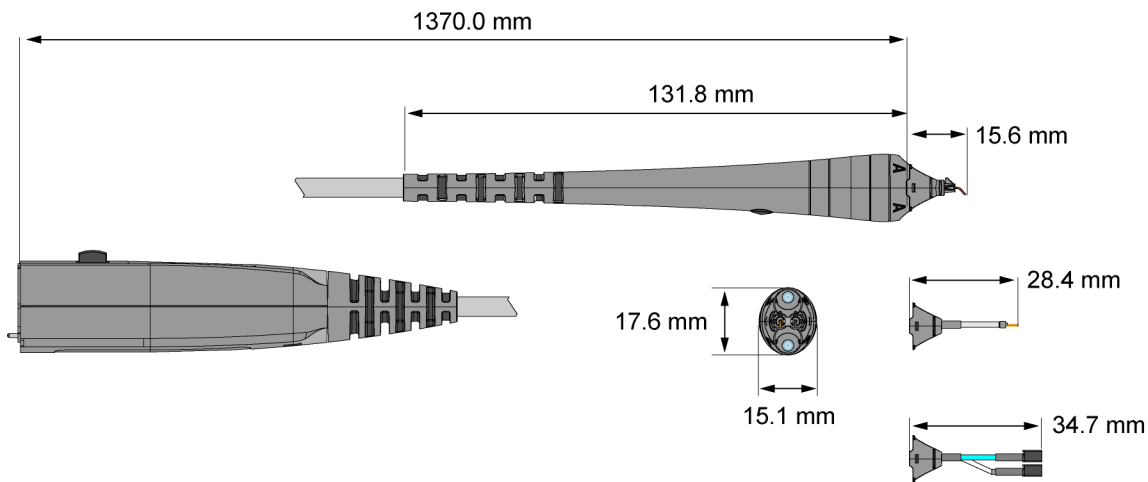

Figure 22 Probe and Tip Dimensions

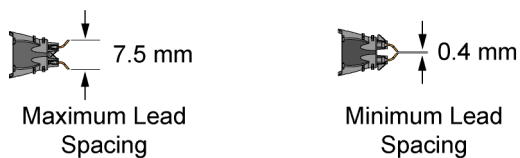

Figure 23 Tip Spacing on N2776A Browser Tip

## 5 Performance Data Plots

With N2776A Browser Tip (2:1 Attenuation)	48
With N2776A Browser Tip (10:1 Attenuation)	52
With N2777A Solder-In Tip (2:1 Attenuation)	53
With N2777A Solder-In Tip (10:1 Attenuation)	55
With N2778A Socketed Tip (2:1 Attenuation)	57
With N2778A Socketed Tip (10:1 Attenuation)	58

This chapter provides the performance plots for the N2752A probe with the browser, solder-in, and socketed tips.

With N2776A Browser Tip (2:1 Attenuation)

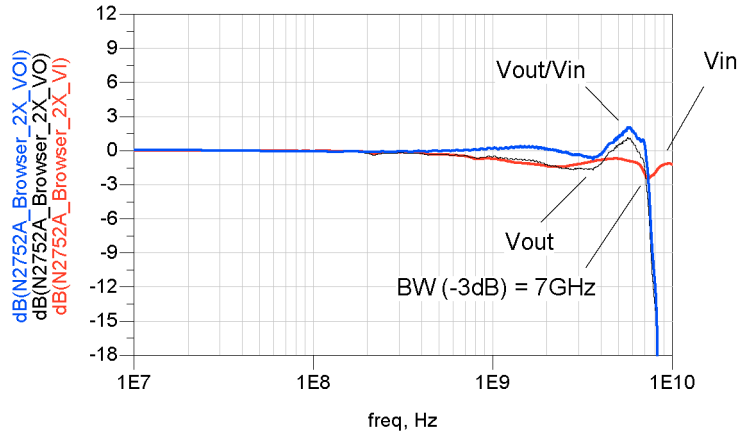

Figure 24 Frequency Response (Differential)

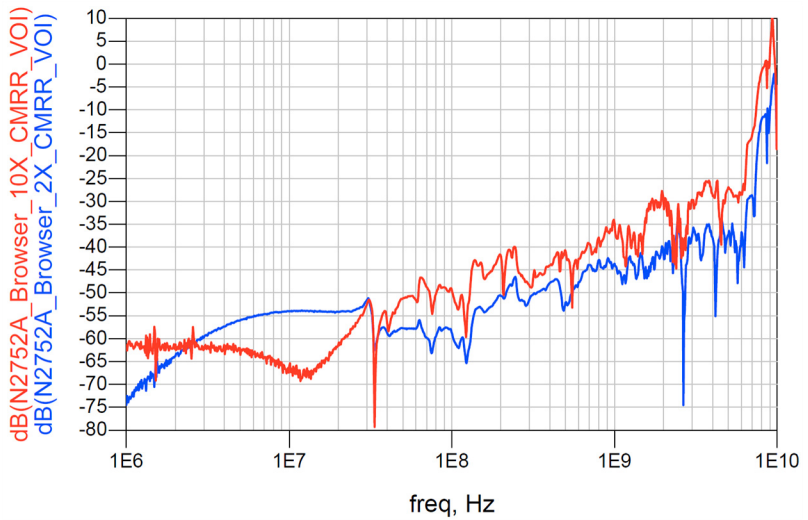

Figure 25 CMRR, Differential (2:1 and 10:1 Attenuation)



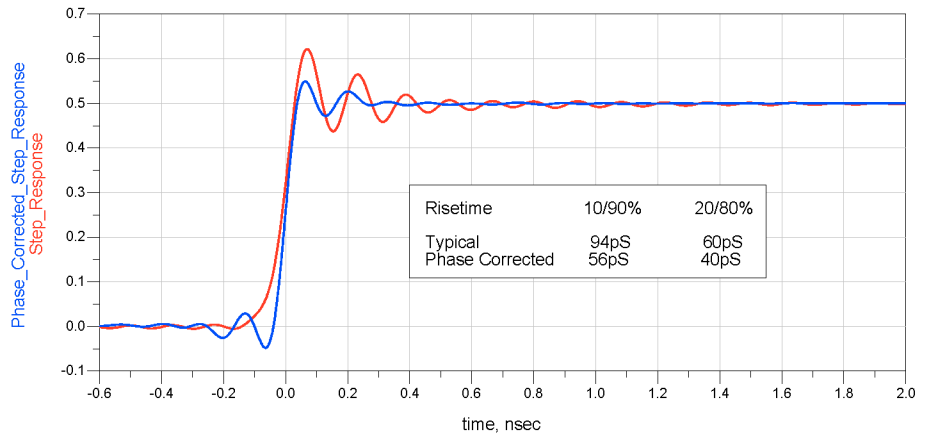

Figure 26 Time Response to an Ideal Step at Probe Tip (Differential) (Step Response)

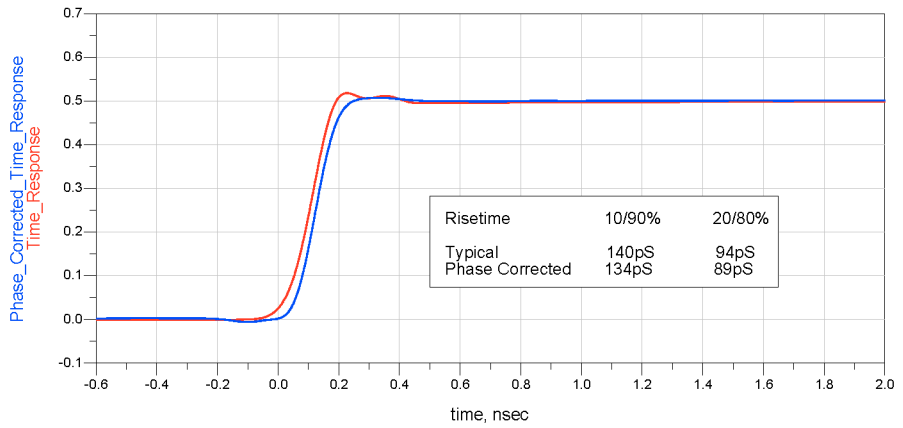
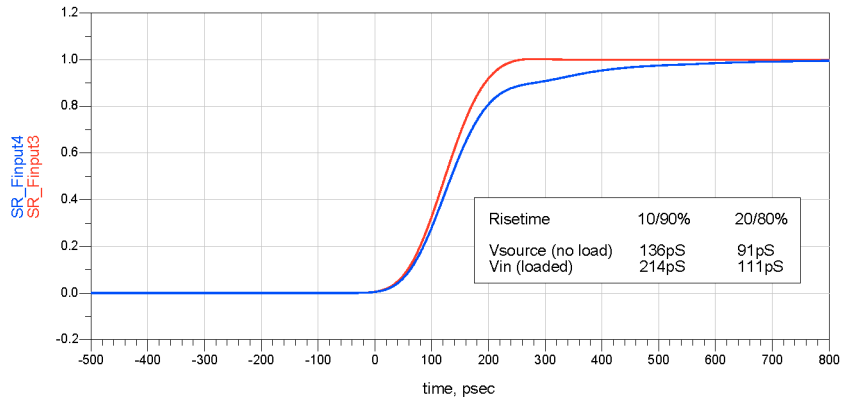

Figure 27 Time Response to a 136 ps Step at Probe Tip (Differential) (Step Tracking)



Red.  $V_{source}$ : Differential 100 ohm source (source and load terminated) with no load applied.  
 Blue.  $V_{in}$ : Same source with N2752A loading applied.

Figure 28 Loading Effect of N2752A (Differential)

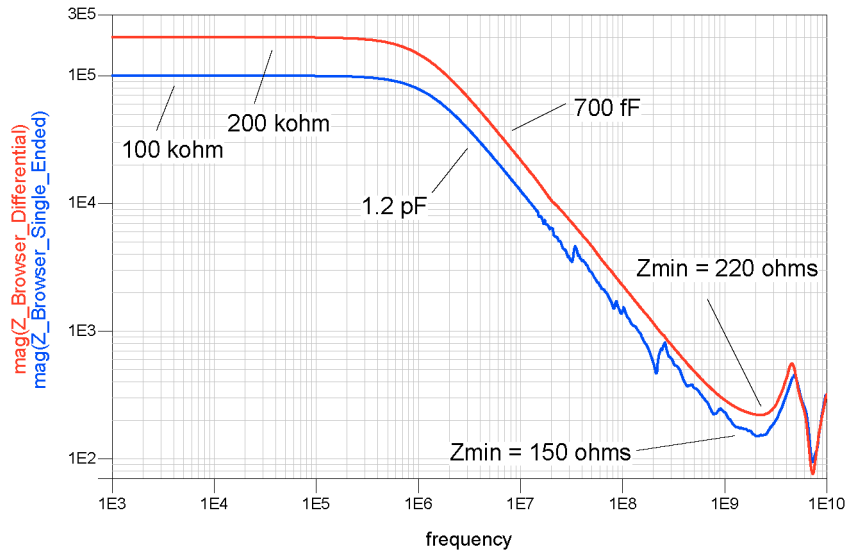

Figure 29 Input Impedance (Differential)

The SPICE model for the green “Modeled” plot shown in **Figure 30** below is described in **“N2752A probe with the N2776A Browser Tip”** on page 30.

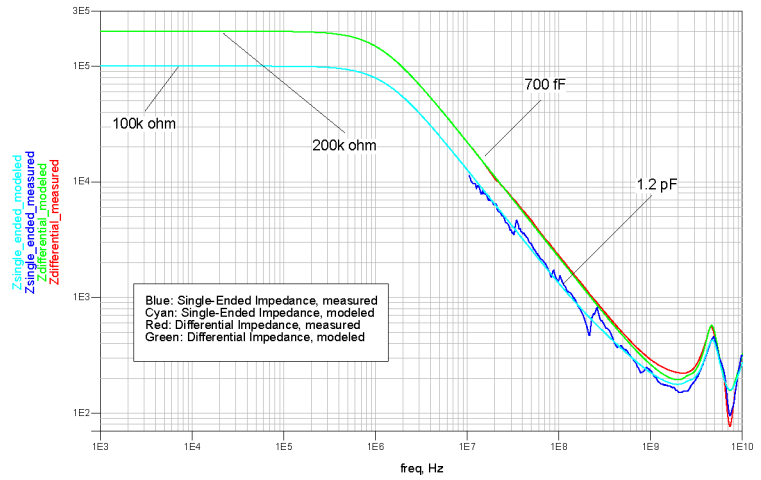

Figure 30 Input Impedance, Measured and Modeled (Differential)

With N2776A Browser Tip (10:1 Attenuation)

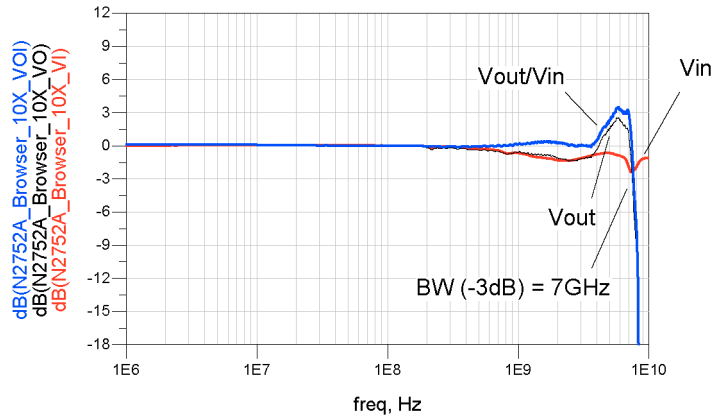

Figure 31 Frequency Response (Differential)

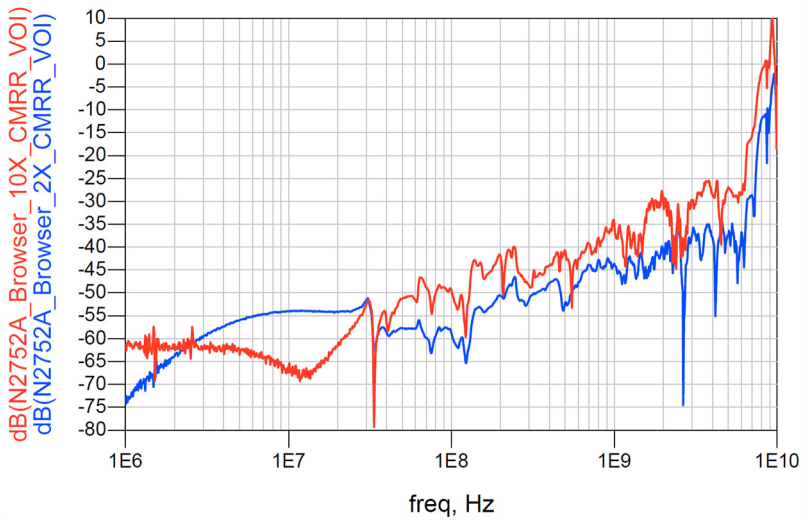

Figure 32 CMRR, Differential (10:1 and 2:1 Attenuation)

### With N2777A Solder-In Tip (2:1 Attenuation)

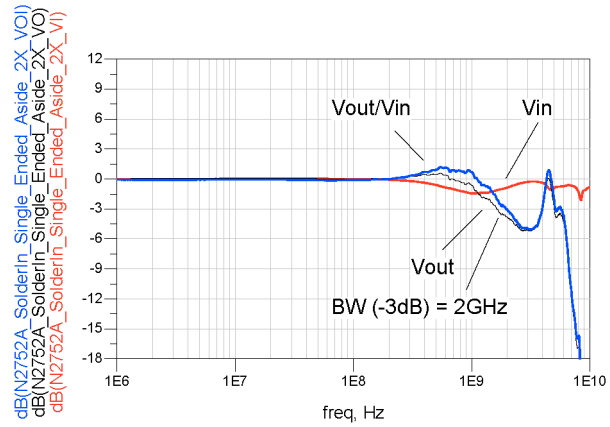

Figure 33 Frequency Response (ASE)

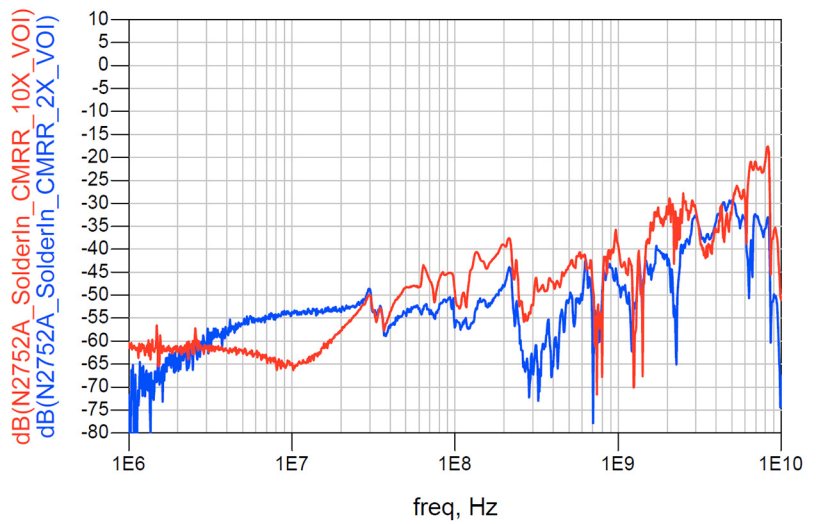

Figure 34 CMRR, Differential (2:1 and 10:1 Attenuation)

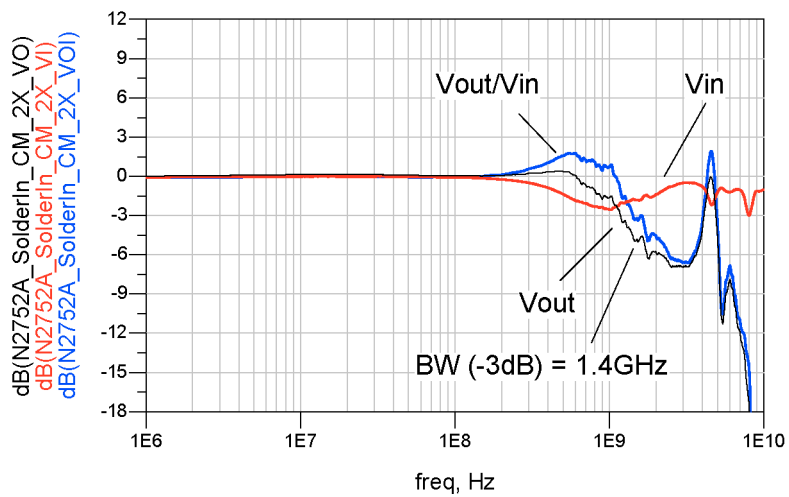

Figure 35 Frequency Response (Common Mode)

With N2777A Solder-In Tip (10:1 Attenuation)

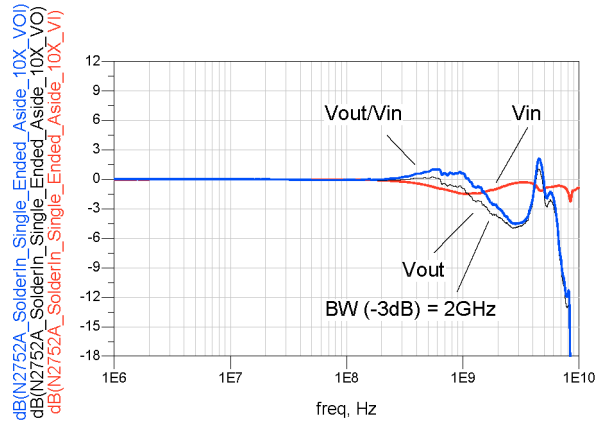

Figure 36 Frequency Response (ASE)

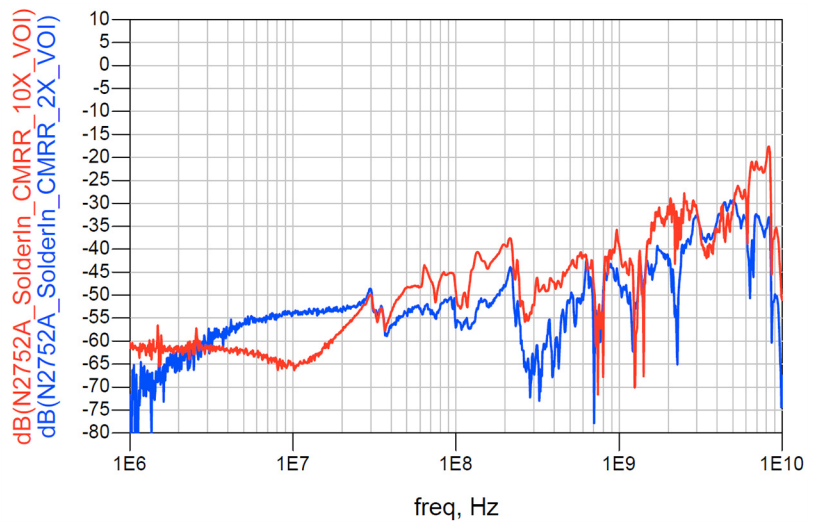

Figure 37 CMRR, Differential (10:1 and 2:1 Attenuation)

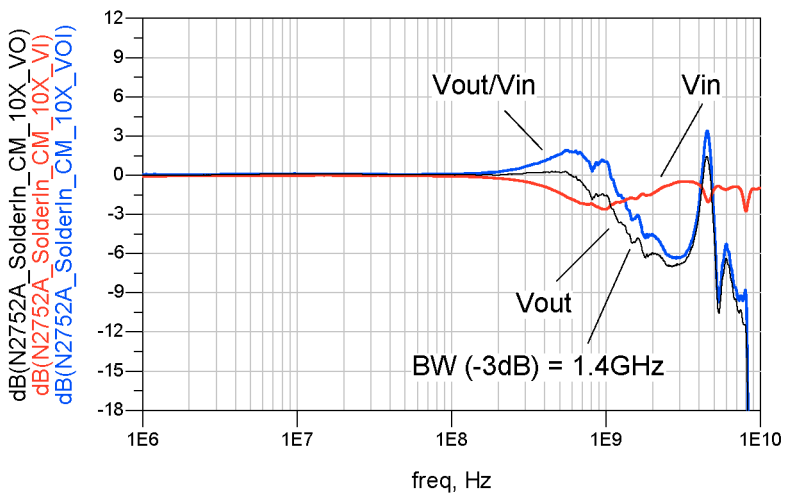

Figure 38 Frequency Response (Common Mode)



With N2778A Socketed Tip (2:1 Attenuation)

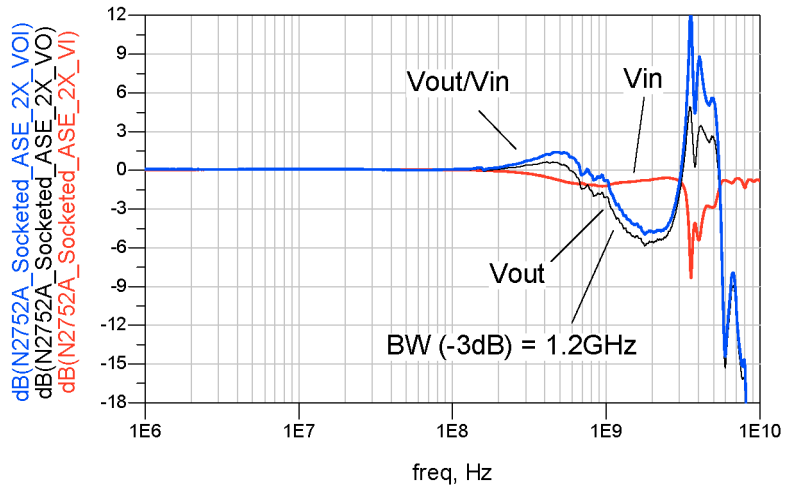

Figure 39 Frequency Response (ASE)

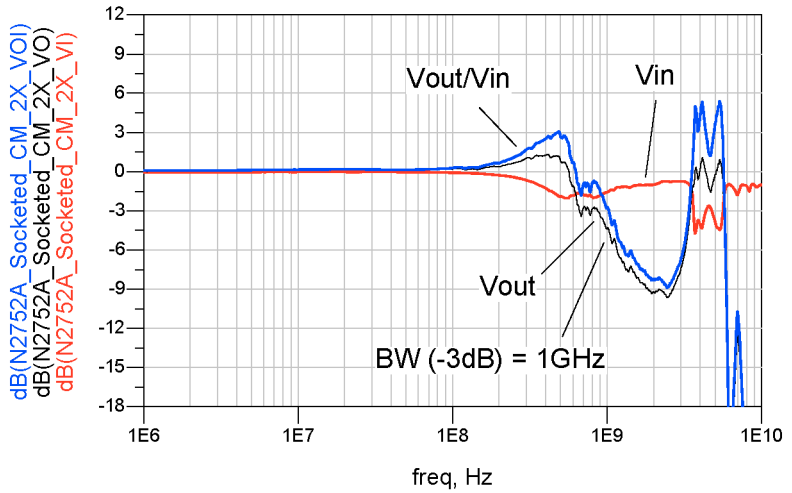

Figure 40 Frequency Response (Common Mode)

With N2778A Socketed Tip (10:1 Attenuation)

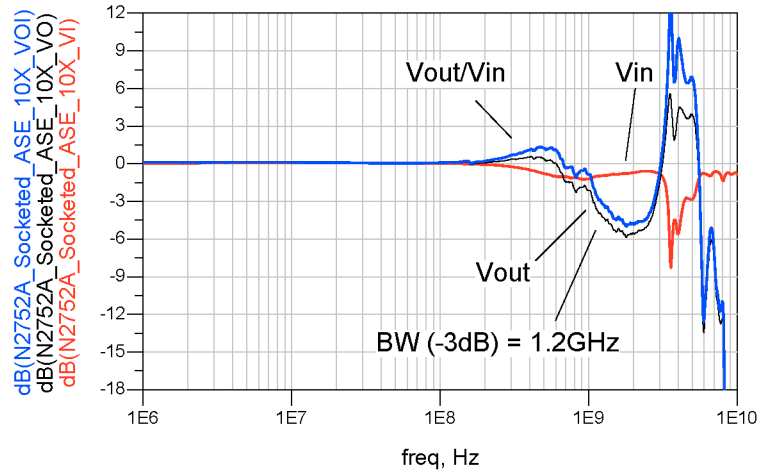

Figure 41 Frequency Response (ASE)

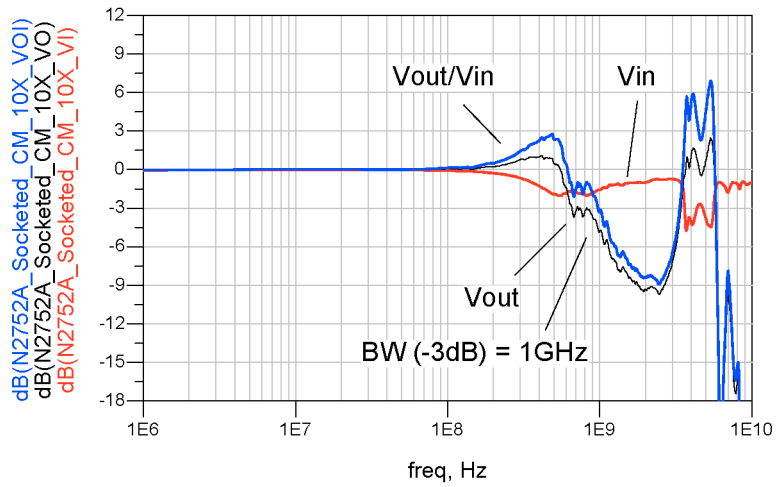

Figure 42 Frequency Response (Common Mode)

## 6 Performance Verification

Test 1. DC Input Resistance **62**

Test 2. Bandwidth **63**

Performance Test Record **73**

This chapter describes two procedures that are used to verify the performance of the N2750/1/2A probes. The performance verification for the probes consists of verifying the probe's DC input resistance and bandwidth.

Due to the very high frequency of the probing system, it is important to carefully adhere to the techniques and procedures described in this chapter to accurately measure the performance.

---

**NOTE** The performance measured in this procedure is for the probe by itself. Keysight high performance real-time scopes (and sampling scopes under certain conditions) will apply probe correction that will further enhance the performance of the probes.

---

---

**NOTE** The probe amplifier must have an N2776A Differential Browser Tip installed during the performance verification procedures.

---

---

**NOTE** Keysight recommends a test interval of one year or 2000 hours of operation.



---

---

**CAUTION** Electrostatic discharge (ESD) can quickly and imperceptibly damage or destroy high performance probes, resulting in costly repairs. Always wear a wrist strap when handling probe components and insure that cables are discharged before being connected.

---

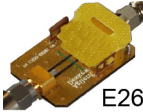
**Table 6 Required Test Equipment (Sheet 1 of 2)**

Test Equipment	Recommended Model	Performance Test	
		1	2
Infiniium Oscilloscope	If a 90000 Q/X-Series oscilloscope is used, an N5442A precision BNC adapter is required.	?	
Digital Multimeter	Keysight 33401A or equivalent). Critical specification: 2 wire resistance accuracy	?	
Vector Network Analyzer (VNA)	Keysight E8361A/C (2-port). Although this procedure assumes an E8361A/C, an equivalent VNA that covers at least a 50 MHz to 13 GHz range is acceptable. The VNA needs to have a bias port for <b>PORT 1</b> which consists of internal bias T's and a BNC port that allows bias to be applied to <b>PORT 1</b> .		?
Test Port Cables/Adaptors	Two cables with male 3.5 mm connectors. If 2.4 mm or 1.85 mm cables are selected, use Keysight 11901D adaptors to convert to 3.5 mm male connectors.		?
PV Fixture	E2655B or N5443A Performance Verification (PV) Fixture. This fixture is included with the Deskew Kit which is shipped with Infiniium oscilloscopes.	 E2655B	 N5443A
Calibration Module	Keysight N4691B Electronic Calibration Module, 300 kHz to 26.5 GHz, 3.5 mm, 2-port. An equivalent 3.5 mm cal kit can be substituted for the N4691B.		?
Probe Power Supply	Keysight 1143A Probe Offset Control and Power Module		?
Probe Adapter	Keysight N1022B Probe Adapter. Or, use a Keysight N5477A Sampling Scope Adapter with a Keysight N5442A Precision BNC adapter.		?

**Table 6 Required Test Equipment (Sheet 2 of 2)**

Test Equipment	Recommended Model	Performance Test	
		1	2
Broadband Load	Keysight SMA male broadband load (Keysight P/N: 1250-3745). This load is <i>included</i> in the N5443A PV and deskew PV and deskew fixture for InfiniiMax III. You can also purchase this load from Mini-circuits (manufacturer part number is <i>ANNE-50X+</i> ). An alternate broadband load is included in the 85056KE01 2.92 mm Standard Mechanical Calibration Kit, DC to 40 GHz.		?
3.5 mm adapter	Keysight 5062-1247 adapter, outside thread 3.5 mm (male) to 3.5 mm (female).		?
Termination	BNC 50 ohm male terminator or equivalent ( <i>not a critical part</i> ). For example, Pomona number 3840-50 or 4119-50.		?
Probe Positioner	<i>Optional</i> . N2787A 3D Probe Positioner or equivalent. 		?
Small Bench Vise	<i>Optional</i> . For holding PV fixture.		?

## Test 1. DC Input Resistance

Refer to the list of required equipment in [Table 6](#) on page 60.

---

**NOTE** Allow the probe to warm up for at least 20 minutes.

---

### Procedure

- 1 Snap the socketed tip onto the probe. The socketed tip is the easiest to use in this test.
- 2 Connect the probe to one of the oscilloscope's channel inputs. This ensures that the probe is powered.
- 3 Turn on the oscilloscope.
- 4 Using the digital multimeter, measure the DC input resistance between leads **A** and **B**. This is the differential resistance and should measure  $200\text{ k}\Omega \pm 2\%$ .
- 5 Measure the single-ended input resistance between lead **A** and the ground lead. The resistance should measure  $100\text{ k}\Omega \pm 2\%$ .
- 6 Measure the single-ended input resistance between lead **B** and the ground lead. The resistance should measure  $100\text{ k}\Omega \pm 2\%$ .
- 7 Enter the measured values in [Table 7](#) on page 73.

## Test 2. Bandwidth

Refer to the list of required equipment in [Table 6](#) on page 60. In the following procedure, the E2655B is shown in the pictures. You could also use the N5443A PV fixtures which uses a slightly different lead clamp.

---

**NOTE** Allow the probe to warm up for at least 20 minutes.

---



---

**NOTE** To ensure accurate measurements, the VNA must warm up for 90 minutes.

---

### Calibrate the Test Setup

- 1 Turn on the E8361A/C VNA and press the **[Preset]** key.
- 2 Connect an N2776A Differential Browser Tip to the probe amplifier that is being tested.

---

**NOTE** The probe that is being tested must have an N2776A probe tip installed for this measurement. Do not attach any other probe tip.

---

- 3 Install the 50-ohm BNC terminator to the VNA's rear-panel **PORT 1 BIAS INPUT**. This provides a DC 50 ohm termination for the probe amplifier's output later in this procedure.
- 4 Connect a USB cable between the calibration module and one of the VNA's front or rear-panel USB connectors as shown in [Figure 43](#).

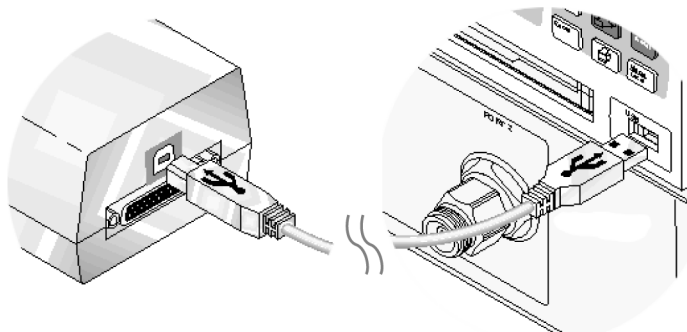

**Figure 43** Connecting Calibration Module's USB Cable

- 5 On the VNA, connect 3.5 mm cables to **PORT 1** and **PORT 2**.

---

**NOTE** If the 2.5 mm or 1.85 mm cables are used, install Keysight 11901D adaptors to convert to 3.5 mm connections at the measurement plane.

---

**CAUTION** As with all precision connector interfaces, torque all connections using the proper torque wrench.

---

- 6 Connect the calibration module and PV fixture as shown in **Figure 44**. Connect the **PORT 1** cable to the input (pincher side) of the PV fixture. Connect the **PORT 2** cable to the output of the calibration module.

---

**NOTE** The measurement reference plane is located at the output of the PV fixture.

---

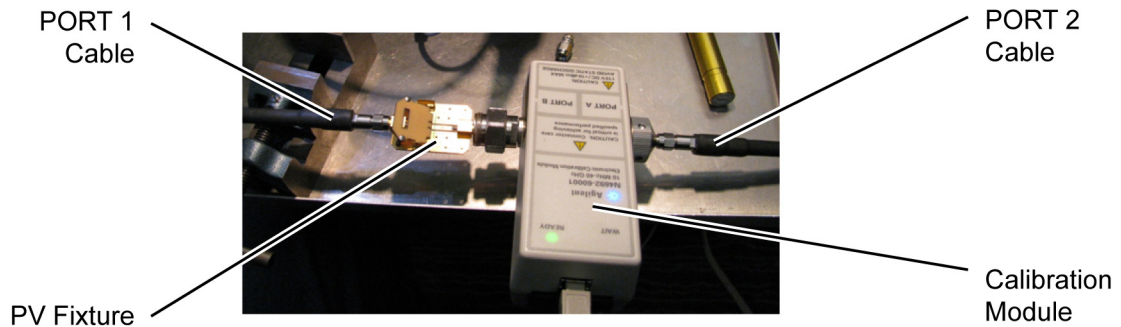

Figure 44 Test Setup for Calibration

- 7 On the VNA's menu, click **Stimulus > Sweep > Sweep Type** to open the Sweep Type dialog box. Enter the following settings:

Type: ..... Log Frequency  
 Start: ..... 50 MHz  
 Stop: ..... 13 GHz  
 Points: ..... 1601

- 8 Press **[Power]** and enter a  $-6$  dBm power level.
- 9 Press **[Avg] > IF Bandwidth** and enter a 1 kHz bandwidth.



- 10** Clear all traces from the VNA's display. Press [**Meas**] > **S21** to display the S21 response.
- 11** Press [**Scale**] and enter the following settings for the response:  
 Scale: . . . . . 3 dB/div  
 Reference Level: . . . . . 0 dB  
 Reference Position: . . . . . 5 divisions
- 12** On the VNA, press [**CAL**] > **Start Cal** > **Cal Wizard**.
- 13** In the Calibration Wizard Begin dialog box, click **Use Electronic Cal (ECal)**. Click **Next**. When the **Select Calibration Ports and ECal Module** panel is displayed, select **2 Port ECal**.
- 14** Continue through the calibration. For more information, consult the VNA's help system.

## Measure $V_{in}$ Response

- 15** Remove the calibration module from the test setup and connect the **PORT 2** cable directly to the output of the PV fixture.
- 16** Connect the equipment as shown in **Figure 45**.
- a** Connect the probe adapter to the probe power supply.
  - b** Attach the 3.5 mm (m) to 3.5 mm (f) adapter to the probe adapter and tighten to the proper torque.
  - c** Connect the N2750/1/2A probe amplifier that you are testing to the probe adapter.
  - d** Turn on the power supply.
  - e** On the 1143A, set the probe offset control button to **Zero** to prevent a probe offset from being applied.

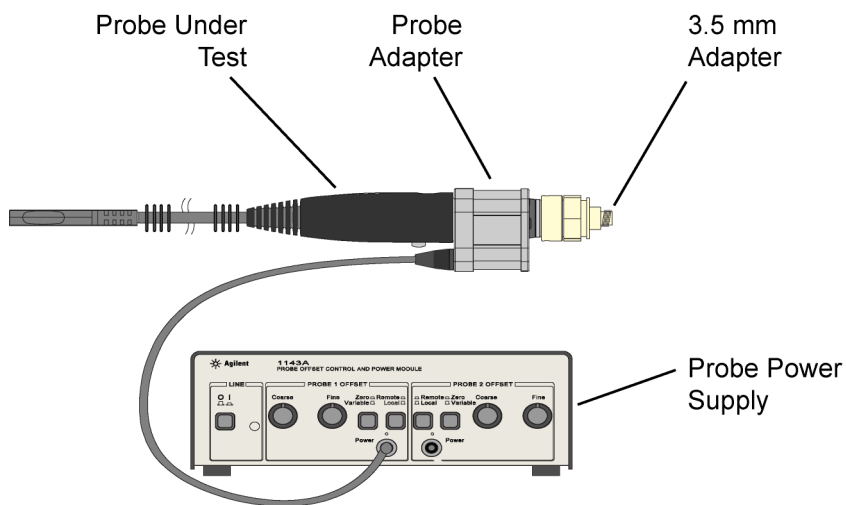

Figure 45 Probe Connected to Probe Adapter (*not to scale*)

**NOTE** Allow the probe to warm up for at least 20 minutes.

- f** If available, use the N2787A 3D Probe Positioner to position the probe straight up and down (perpendicular) to the PV Fixture as shown in [Figure 46](#).

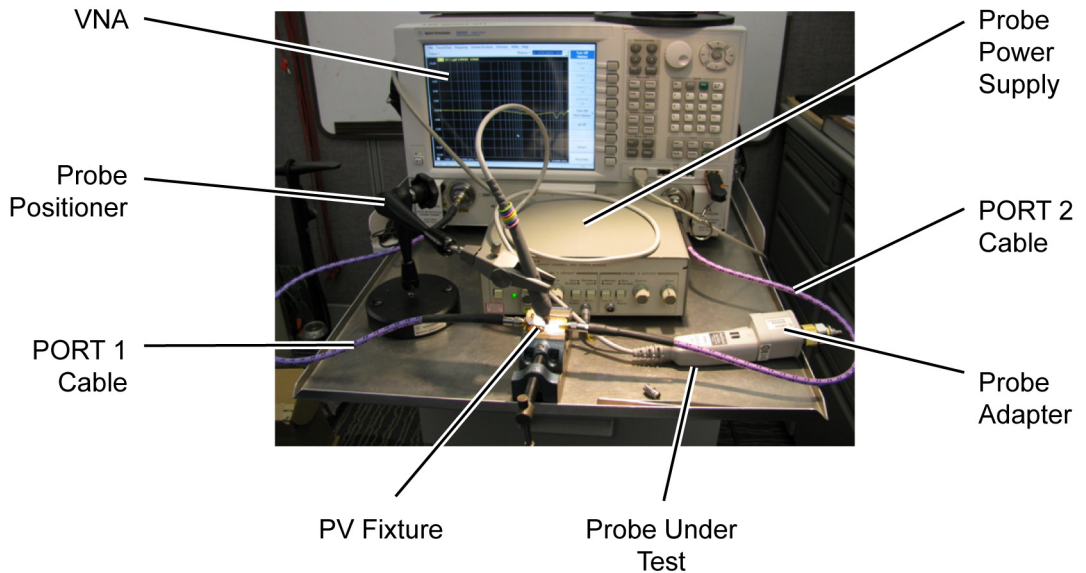

Figure 46 Measurement setup for  $V_{in}$

- 17** Spread the probe tip's wires so that the tips are slightly wider than the gap between the signal trace and the ground on PV fixture. See [Figure 47](#) on page 68.

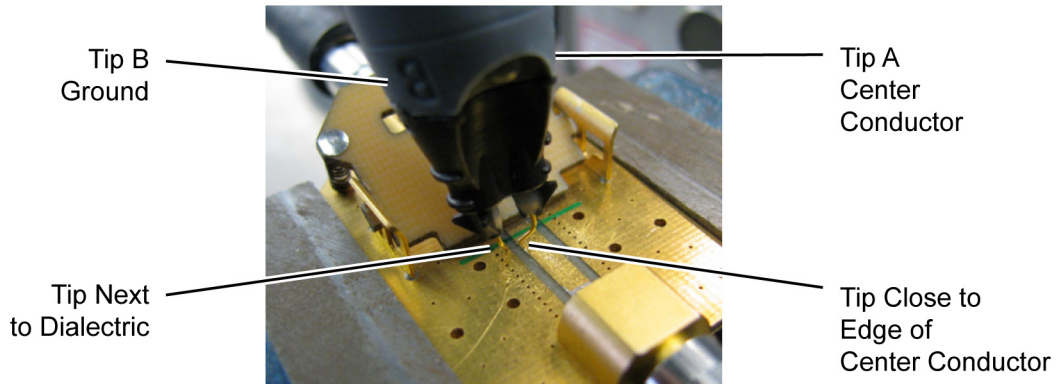

Figure 47 Close-Up Showing Tip Spacing and Position

- g** Position the probe's A tip on the center conductor as close to the edge of the conductor as possible. Position the probe's B tip to the ground, as close to the dielectric as possible.

**18** On the VNA, press **[Trigger] > Single** to trigger a single sweep. The display should look similar to **Figure 48** on page 69.

---

**NOTE** If it looks noticeably different, the probe tip wires may not be making contact under the pinchers.

---

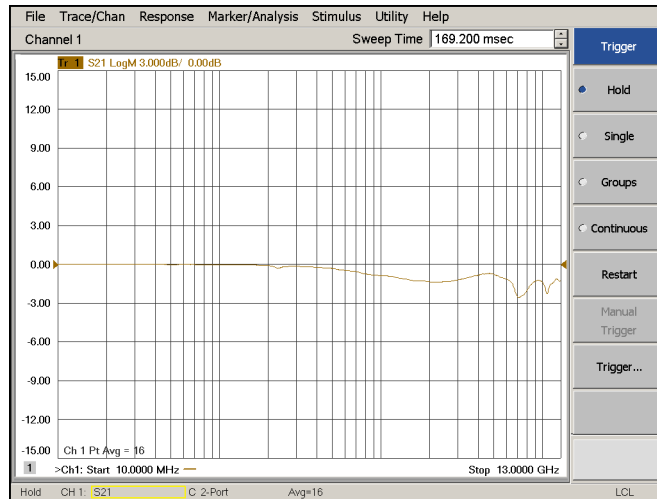

Figure 48  $V_{in}$  Response

- 19 On the VNA, press **[Memory]** > **Data** > **Memory** to save the de-embedded input voltage trace into memory.

### Measure $V_{out}$ Response

- 20 Disconnect the **PORT 2** cable from output of the PV fixture and connect the cable to the output of the probe adapter as shown in **Figure 49** on page 70.
- 21 Connect the broadband load to the output of the PV fixture. Torque all connections.

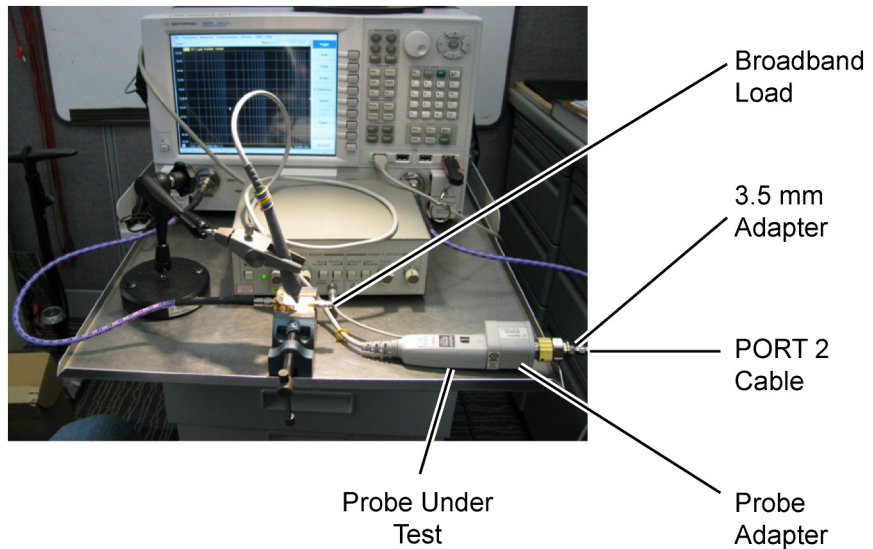

Figure 49 Measurement Setup for  $V_{out}$

**22** On the VNA, press **[Trigger] > Single** to trigger a single sweep.

**23** Press **[Scale] > Reference Level** and adjust the reference level until the 50 MHz point (at the display's left side) is at center screen.

---

NOTE The reference level should be approximately  $-15.3$  dB, but can vary a few tenths of a dB either way.

---

**24** The display should look similar to **Figure 50** on page 71.

---

NOTE If it looks noticeably different, the probe tip wires may not be making contact under the pinchers.

---

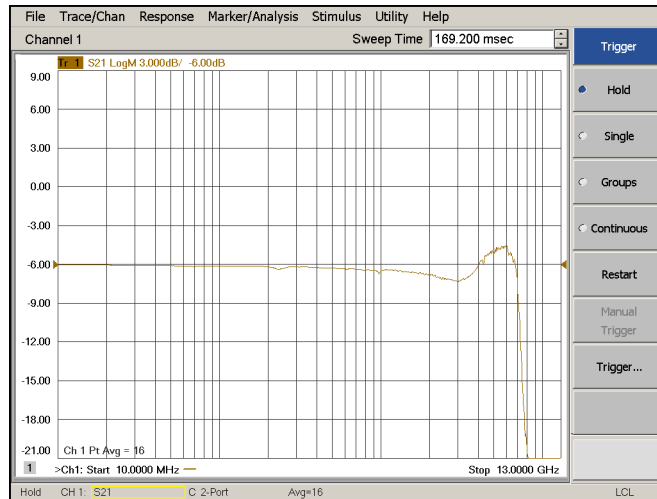

**Figure 50**  $V_{out}$  Response

Determine the BW

**25** Press **[Memory]** > **Data Math** > **Data/Memory**.

This step divides the active trace (de-embedded  $V_{out}$ ) by the memory trace (de-embedded  $V_{in}$ ) to show the voltage transfer function of the probe or  $V_{out}/V_{in}$ .

**26** Press **[Scale]** > **Reference Level** and adjust the reference level so that the 50 MHz point is at center screen. See **Figure 51** on page 72.

**27** Turn on a marker and adjust the marker to where the trace crosses 3 dB below the 50 MHz point. Because the scale is set to 3 dB/div, this occurs one division below center screen,

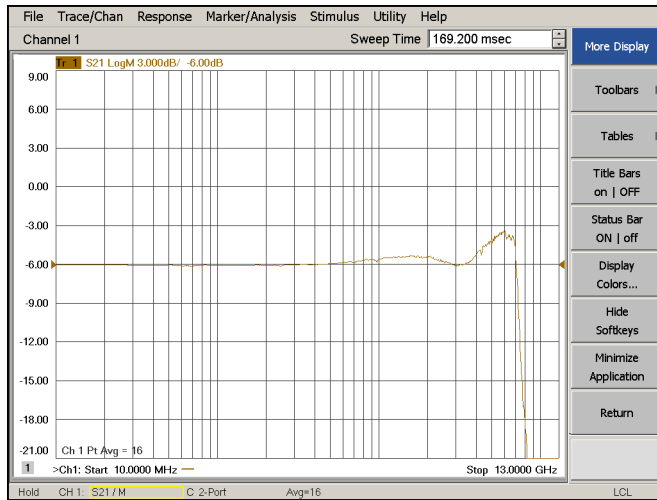

Figure 51 Vout/Vin Response

**28** Verify that the BW meets the following specification and enter the value in **Table 7**, “N2750/1/2A Performance Test Record,” on page 73:

- N2750A: .....  $\geq 1.5$  GHz
- N2751A: .....  $\geq 3.5$  GHz
- N2752A: .....  $\geq 6$  GHz



## Performance Test Record

**Table 7** N2750/1/2A Performance Test Record

<b>Model #:</b>	<b>Date:</b>	<b>Tested by:</b>	
<b>Serial #:</b>	<b>Recommended next test date:</b>		
<b>Recommended Test Interval: 1 year / 2000 hours</b>			
<b>Probe Amplifier</b>	<b>Test Limits</b>	<b>Result</b>	<b>Pass/Fail</b>
<b>Test 1. DC Input Resistance Performance Test</b>			
N2750/1/2A	200 k $\Omega$ $\pm$ 2% (differential, between <b>A</b> and <b>B</b> leads)		
	100 k $\Omega$ $\pm$ 2% (single-ended, between <b>A</b> and ground)		
	100 k $\Omega$ $\pm$ 2% (single-ended, between <b>B</b> and ground)		
<b>Test 2. Bandwidth</b>			
N2750A	$\geq$ 1.5 GHz		
N2751A	$\geq$ 3.5 GHz		
N2752A	$\geq$ 6.0 GHz		



# Index

## Numerics

1143A Probe Offset Control and Power Module, 60  
3D probe positioner, 8, 40

## A

A probe lead, 17  
attaching tip, 11  
attenuation ratio, 22  
autoscale, 21  
Autoscale Quick Action, 21

## B

B probe lead, 17  
bandwidth, 5, 7  
button, probe, 20

## C

cable, 9  
calibration module, 60  
calibration, probe, 39  
CE mark, 27  
channel identification rings, 9  
circuit connections, 17  
cleaning, 23  
clear display, 21  
Clear Display Quick Action, 21  
CMRR, 8  
common mode measurements, 16  
Common Mode Rejection Ratio, 8  
Common Mode setting, 19  
compatible oscilloscopes, 7  
connections  
  circuit, 17  
  InfiniiMode, 17  
CSA mark, 27  
Customize Multipurpose, 21

## D

data acquisition, 21  
differential measurements, 16

Differential setting, 19  
dimensions, 46  
disable, probe button, 22

## E

E2655B PV fixture, 8  
ESD, 5

## F

functional test, 22

## H

Headlight Intensity Quick Action, 21

## I

InfiniiMode, 9, 12, 16  
  connections, 17  
Infiniium 9000 Series, 7  
Infiniium 90000 Q/X-Series, 7  
Infiniium 90000 Series, 7  
inspecting, 23  
ISM1-A, 27

## K

Keysight Technologies, contacting, 24

## L

light, 6  
light intensity, 21

## M

Multipurpose functions, 21  
Multipurpose Quick Action, 21

## N

N1022B probe adapter, 60  
N2776A browser tip, 10, 12, 29  
  SPICE model with N2752A, 30

N2777A solder-in tip, 10, 13  
  SPICE model with N2750A, 33  
N2778A socketed tip, 10, 14  
N2787A probe positioner, 8  
N4691B Electronic Calibration Module, 60  
N5442A, 8  
N5442A adapter, 7  
N5443A PV fixture, 8

## O

Open/Close Probe Setup Dialog Quick Action, 21  
oscilloscope compatibility, 7

## P

performance test record, 73  
performance verification, 59  
performance verification and deskew fixture, 8  
Precision BNC adapter, 8  
probe  
  attenuation ratio, 22  
  bandwidth, 7  
  button, 6, 20  
  cleaning, 23  
  configuration, 19  
  handling, 25  
  inspecting, 23  
  light, 21  
  service, 24  
  probe button, disable, 22  
  probe calibration, 39  
  Probe Calibration dialog box, 40  
  Probe Configuration dialog box, 19, 20  
  probe light, 21  
  probe power supply, 60  
  PV fixture, 39, 60

## Q

Quick Action  
  Quick Control, 21  
  Quick E-mail, 21

## Index

- Quick Execute, 21
- Quick Meas, 21
- Quick Print, 21
- Quick Screen, 21
- Quick Setup, 21
- Quick Waveform, 21
- Quick Action button, 9, 20
- Quick Action field, 20
- Quick Action probe button, 6
- QuickControl, 21
- QuickE-mail, 21
- QuickExecute, 21
- QuickMeas, 21
- QuickPrint, 21
- QuickScreen, 21
- QuickSetup, 21
- QuickWaveform, 21

## R

- removing tip, 11
- repeatability, 8
- returning for service, 24
- RUN acquisition, 21
- Run/Stop Quick Action, 21

## S

- safety information, 25
- Single acquisition, 21
- Single Quick Action, 21
- Single-Ended A setting, 19
- Single-Ended B setting, 19
- single-ended measurements, 8, 16
- specifications, 43
- SPICE Data, 31, 35
- SPICE model, 51
- SPICE models, 29
  - N2750A with N2777A tip, 33
  - N2752A with N2776A tip, 30
- STOP acquisition, 21

## T

- tip
  - attaching, 11
  - browser, 12
  - removal, 11
  - socketed, 14

- solder-in, 13
- spacing, 12
- Toggle Headlight Quick Action, 21

## V

- Vector Network Analyzer, 60
- VNA, 60