

# Keysight N2779A Power Supply

User's Guide



# Notices

© Keysight Technologies, Inc. 2010-2014

No part of this manual may be reproduced in any form or by any means (including electronic storage and retrieval or translation into a foreign language) without prior agreement and written consent from Keysight Technologies, Inc. as governed by United States and international copyright laws.

## Manual Part Number

N2779-97005

## Edition

September 2014

Printed in Malaysia

Published by:

Keysight Technologies, Inc.  
1900 Garden of the Gods Road  
Colorado Springs, CO 80907 USA

## Warranty

The material contained in this document is provided “as is,” and is subject to being changed, without notice, in future editions. Further, to the maximum extent permitted by applicable law, Keysight disclaims all warranties, either express or implied, with regard to this manual and any information contained herein, including but not limited to the implied warranties of merchantability and fitness for a particular purpose. Keysight shall not be liable for errors or for incidental or consequential damages in connection with the furnishing, use, or performance of this document or of any information contained herein. Should Keysight and the user have a separate written agreement with warranty terms covering the material in this document that conflict with these terms, the warranty terms in the separate agreement shall control.

## Technology Licenses

The hardware and/or software described in this document are furnished under a license and may be used or copied only in accordance with the terms of such license.

## Restricted Rights Legend

If software is for use in the performance of a U.S. Government prime contract or subcontract, Software is delivered and licensed as “Commercial computer software” as defined in DFAR 252.227-7014 (June 1995), or as a “commercial item” as defined in FAR 2.101(a) or as “Restricted computer software” as defined in FAR 52.227-19 (June 1987) or any equivalent agency regulation or contract clause. Use, duplication or disclosure of Software is subject to Keysight Technologies’ standard commercial license terms, and non-DOD Departments and Agencies of the U.S. Government will receive no greater than Restricted Rights as defined in FAR 52.227-19(c)(1-2) (June 1987). U.S. Government users will receive no greater than Limited Rights as defined in FAR 52.227-14

(June 1987) or DFAR 252.227-7015 (b)(2) (November 1995), as applicable in any technical data.

## Safety Notices

### CAUTION

A **CAUTION** notice denotes a hazard. It calls attention to an operating procedure, practice, or the like that, if not correctly performed or adhered to, could result in damage to the product or loss of important data. Do not proceed beyond a **CAUTION** notice until the indicated conditions are fully understood and met.

### WARNING

A **WARNING** notice denotes a hazard. It calls attention to an operating procedure, practice, or the like that, if not correctly performed or adhered to, could result in personal injury or death. Do not proceed beyond a **WARNING** notice until the indicated conditions are fully understood and met.

# N2779A Power Supply

Safety Precautions	6
Safety Information	8
Informations relatives à la sécurité	12
Characteristics and Regulatory Information	17
Service	19

This N2779A power supply is a special-purpose power supply for the N2780A/B, N2781A/B, N2782A/B, N2783A/B current probes. You can simultaneously connect up to three probes to the N2779A's front-panel probe-power connectors.

Before connecting your Keysight probe to the N2779A, refer to the *probe's* user's guide to learn how to perform measurements.

Use the N2779A *only* with the N2780A/B, N2781A/B, N2782A/B, and N2783A/B current probes, which are powered using the N2779A's front-panel probe-power connectors. **Figure 1** shows the N2779A's front and rear panels. Notice that the **POWER** switch is located on the rear panel.

---

**WARNING**

**Use only with Keysight N2780A/B, N2781A/B, N2782A/B, or N2783A/B current probes. Connecting the power supply to incompatible equipment may result in fire or electric shock.**

---

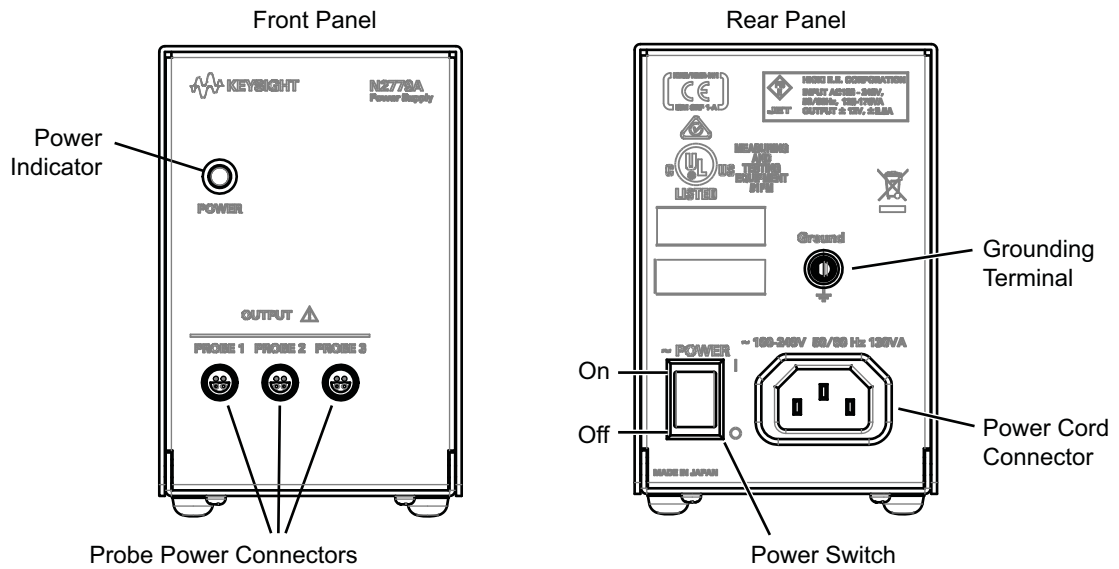

**Figure 1** Front and Rear Panels

**CAUTION**

Allow at least 5 cm clearance on both sides and above the power supply for proper cooling. Ventilation holes for heat radiation are provided on the top and side panels of the product. Installation of the product with the ventilation holes obstructed may cause a malfunction or fire.

**Table 1** Instrument Markings

Marking	Description
	"Caution" or "Warning" risk of danger marked on product. Refer to " <b>Safety Precautions</b> " on page 6.
	Earth terminal symbol. Used to indicate a circuit common connected to grounded chassis.
	Indicates AC (Alternating Current).
	Indicates power on.
	Indicates power off.

## To Connect the N2779A

- 1 Position the N2779A so that the power switch and power cord may be easily reached.
- 2 Turn the power switch off and connect the power cord.

---

**WARNING** Use only the supplied power cord.

---

- 3 Connect the power plug of your probe to one of the N2779A's front-panel probe-power connectors. Up to three probes may be connected to the N2779A.

---

**CAUTION** Before turning on the power, make sure that the voltage of the power supply being used matches the supply voltage indicated on the rear panel of the unit. Connecting to a different supply voltage may result in equipment damage or incorrect measurements.

---

- 4 Turn the N2779A's rear-panel power switch on, and check that the front-panel power indicator is lit.

## To Disconnect Power

- 1 Turn the N2779A's power switch off.
- 2 Disconnect the power plugs of all connected probes from the N2779A.
- 3 Disconnect the power cord from the N2779A.
- 4 The Appliance Coupler is the equipment disconnect device. Position the equipment so that the Appliance Coupler is free from obstruction.

## To Clean the Instrument

If the N2779A requires cleaning, perform the following steps:

- 1 Remove power from the instrument.
- 2 Clean the external surfaces of the instrument with a soft, dry cloth. Make sure that the instrument is completely dry before reconnecting it to a power source. Do not attempt to clean the current probes.

## Safety Precautions

This apparatus has been designed and tested in accordance with IEC Publication 1010, Safety Requirements for Measuring Apparatus, and has been supplied in a safe condition. This is a Safety Class I instrument (provided with terminal for protective earthing). Before applying power, verify that the correct safety precautions are taken as described in the following warnings. In addition, note the external markings on the instrument as described in [Table 1](#) on page 4.

---

**WARNING**

**If the instrument is damaged, or if it fails to operate according to the characteristics in this manual, remove the power cord and contact Keysight Technologies.**

---

**WARNING**

**Before turning on the instrument, you must connect the protective earth terminal of the instrument to the protective conductor of the (mains) power cord. The mains plug shall only be inserted in a socket outlet provided with a protective earth contact. You must not negate the protective action by using an extension cord (power cable) without a protective conductor (grounding). Grounding one conductor of a two-conductor outlet is not sufficient protection.**

---

**WARNING**

**If you energize this instrument by an auto transformer (for voltage reduction or mains isolation), the common terminal must be connected to the earth terminal of the power source.**

---

**WARNING**

**Whenever it is likely that the ground protection is impaired, you must make the instrument inoperative and secure it against any unintended operation.**

---

**WARNING**

**Service instructions are for trained service personnel. To avoid dangerous electric shock, do not perform any service unless qualified to do so. Do not attempt internal service or adjustment unless another person, capable of rendering first aid and resuscitation, is present.**

---

**WARNING**

**Do not install substitute parts or perform any unauthorized modification to the instrument.**

---

---

**WARNING**

Capacitors inside the instrument may retain a charge even if the instrument is disconnected from its source of supply.

---

**WARNING**

Do not operate the instrument in the presence of flammable gases or fumes. Operation of any electrical instrument in such an environment constitutes a definite safety hazard.

---

**WARNING**

Do not subject the unit to vibration or shocks during transport or handling. Be especially careful to avoid dropping the unit.

---

**WARNING**

Do not store the unit where it will be exposed to direct sunlight, high temperature, high humidity, or condensation. If exposed to such conditions, the unit may be damaged, the insulation may deteriorate, and the unit may no longer satisfy its specifications.

---

**WARNING**

When unplugging the power cord from the power receptacle or from the unit, grasp the plug, not the cord, in order to avoid damaging the cable.

---

**WARNING**

This unit is not constructed to be waterproof or dust proof, so do not use it in a very dusty environment or in one where it will get wet. For indoor use only.

---

**WARNING**

Do not use the instrument in a manner not specified by the manufacturer.

---

## Safety Information

The following general safety precautions must be observed during all phases of operation of this instrument. Failure to comply with these precautions or with specific warnings or operating instructions in the product manuals violates safety standards of design, manufacture, and intended use of the instrument. Keysight Technologies assumes no liability for the customer's failure to comply with these requirements. Product manuals are provided with your instrument on CD-ROM and/or in printed form. Printed manuals are an option for many products. Manuals may also be available on the Web. Go to [www.keysight.com](http://www.keysight.com) and type in your product number in the Search field at the top of the page.

### General

Do not use this product in any manner not specified by the manufacturer. The protective features of this product may be impaired if it is used in a manner not specified in the operation instructions.

### Before Applying Power

Verify that all safety precautions are taken. Make all connections to the unit before applying power. Note the instrument's external markings described in [Table 2](#) on page 10.

### Ground the Instrument

If your product is provided with a grounding type power plug, the instrument chassis and cover must be connected to an electrical ground to minimize shock hazard. The ground pin must be firmly connected to an electrical ground (safety ground) terminal at the power outlet. Any interruption of the protective (grounding) conductor or disconnection of the protective earth terminal will cause a potential shock hazard that could result in personal injury.

### Fuses

See the user's guide or operator's manual for information about line-fuse replacement. Some instruments contain an internal fuse, which is not user accessible.



## Do Not Operate in an Explosive Atmosphere

Do not operate the instrument in the presence of flammable gases or fumes.

## Do Not Remove the Instrument Cover

Only qualified, service-trained personnel who are aware of the hazards involved should remove instrument covers. Always disconnect the power cable and any external circuits before removing the instrument cover.

## Cleaning

Clean the outside of the instrument with a soft, lint-free, slightly dampened cloth. Do not use detergent or chemical solvents.

## Do Not Modify the Instrument

Do not install substitute parts or perform any unauthorized modification to the product. Return the product to a Keysight Sales and Service Office for service and repair to ensure that safety features are maintained.

## In Case of Damage

Instruments that appear damaged or defective should be made inoperative and secured against unintended operation until they can be repaired by qualified service personnel.

---

**CAUTION**

A **CAUTION** notice denotes a hazard. It calls attention to an operating procedure, practice, or the like that, if not correctly performed or adhered to, could result in damage to the product or loss of important data. Do not proceed beyond a **CAUTION** notice until the indicated conditions are fully understood and met.

---













**WARNING**

A **WARNING** notice denotes a hazard. It calls attention to an operating procedure, practice, or the like that, if not correctly performed or adhered to, could result in personal injury or death. Do not proceed beyond a **WARNING** notice until the indicated conditions are fully understood and met.







---

## Safety Symbols

**Table 2** Description of Safety related symbols that may appear on a product (Sheet 1 of 2)

Symbol	Description
	Direct current
	Alternating current
	Both direct and alternating current
	Three phase alternating current
	Earth ground terminal
	Protective earth ground terminal
	Frame or chassis ground terminal
	Terminal is at earth potential
	Equipotentiality
N	Neutral conductor on permanently installed equipment
L	Line conductor on permanently installed equipment
	On (mains supply)
○	Off (mains supply)
	Standby (mains supply). The instrument is not completely disconnected from the mains supply when the power switch is in the standby position
	In position of a bi-stable push switch
	Out position of a bi-stable push switch
	Equipment protected throughout by DOUBLE INSULATION or REINFORCED INSULATION

**Table 2** Description of Safety related symbols that may appear on a product (Sheet 2 of 2)

Symbol	Description
	Caution, refer to accompanying documentation
	Caution, risk of electric shock
	Do not apply around or remove from HAZARDOUS LIVE conductors
	Application around and removal from HAZARDOUS LIVE conductors is permitted.
	Caution, hot surface
	Ionizing radiation
<b>CAT I</b>	IEC Measurement Category I
<b>CAT II</b>	Measurement Category II
<b>CAT III</b>	Measurement Category III
<b>CAT IV</b>	Measurement Category IV

## Informations relatives à la sécurité

Les consignes de sécurité générales présentées dans cette section doivent être appliquées au cours des différentes phases d'utilisation de cet appareil. Le non-respect de ces précautions ou des avertissements et consignes d'utilisation spécifiques mentionnés dans les manuels des produits constitue une violation des normes de sécurité relatives à la conception, à la fabrication et à l'usage normal de l'instrument. Keysight Technologies ne saurait être tenu responsable du non-respect de ces consignes. Les manuels des produits sont fournis avec votre instrument sur CD-ROM et/ou en version papier. Les versions papier des manuels sont en option pour de nombreux produits. Certains manuels sont également disponibles en ligne. Pour y accéder, allez sur le site [www.keysight.com](http://www.keysight.com) et saisissez la référence de votre produit dans le champ Rechercher qui se trouve en haut de la page.

### Généralités

Utilisez ce produit uniquement dans le cadre prévu par le fabricant. Si vous ne respectez pas les instructions d'utilisation, les fonctions de sécurité du produit risquent d'être inhibées.

### Avant la mise sous tension

Vérifiez que vous avez bien respecté toutes les consignes de sécurité. Faites tous les branchements au niveau de l'appareil avant de mettre ce dernier sous tension. Tenez compte des marquages externes à l'instrument décrits à la section « Symboles de sécurité ».

### Mise à la terre de l'instrument

Si une prise de mise à la terre est fournie avec le produit, le châssis et le capot de l'instrument doivent être reliés à la terre afin de limiter les risques d'électrocution. Le contact à la terre doit être solidement connecté à une borne de terre (de sécurité) au niveau de la prise de courant. Toute interruption du conducteur de protection (mise à la terre) ou tout débranchement de la borne de terre de protection donne lieu à un risque d'électrocution pouvant entraîner des blessures graves.

### Fusibles

Pour obtenir des instructions sur le changement des fusibles de ligne, consultez le guide de l'utilisateur ou le manuel d'instructions. Certains instruments comportent un fusible interne inaccessible à l'utilisateur.

## Ne pas utiliser en atmosphère explosive

N'utilisez pas l'instrument en présence de gaz ou de vapeurs inflammables.

## Ne pas démonter le capot de l'instrument

Seules des personnes qualifiées, formées à la maintenance et conscientes des risques d'électrocution encourus sont autorisées à démonter les capots de l'instrument. Débranchez toujours le cordon d'alimentation secteur et tous les circuits externes avant de démonter le capot de l'instrument.

## Nettoyage

Nettoyez la partie externe de l'instrument à l'aide d'un chiffon doux et non pelucheux, légèrement humidifié. N'utilisez pas de détergents ou de solvants chimiques.

## Ne pas modifier l'instrument

N'installez pas de composants de remplacement et n'apportez aucune modification non autorisée à l'appareil. Pour toute opération de maintenance ou de réparation, renvoyez l'appareil à un bureau de vente et de service après-vente Keysight, afin d'être certain que les fonctions de sécurité seront maintenues.

## En cas de dommages

Les instruments endommagés ou défectueux doivent être désactivés et protégés contre toute utilisation involontaire jusqu'à ce qu'ils aient été réparés par une personne qualifiée.

---

**ATTENTION**

La mention ATTENTION indique un risque. Si la manoeuvre ou le procédé correspondant n'est pas exécuté correctement, il peut y avoir un risque de dommages à l'appareil ou de perte de données importantes. En présence de la mention ATTENTION, il convient de s'interrompre tant que les conditions indiquées n'ont pas été parfaitement comprises et respectées.

---

**AVERTISSEMENT**

**Utilisez seulement avec des sondes Keysight N2780A/B, N2781A/B, N2782A/B ou N2783A/B. Le raccordement de l'alimentation à de l'équipement incompatible peut provoquer un incendie ou un choc électrique.**

---

---















**AVERTISSEMENT**

---







La mention AVERTISSEMENT signale un danger pour la sécurité de l'opérateur. Si la manœuvre ou le procédé correspondant n'est pas exécuté correctement, il peut y avoir un risque pour la santé des personnes. En présence d'une mention AVERTISSEMENT, il convient de s'interrompre tant que les conditions indiquées n'ont pas été parfaitement comprises et respectées.

## Symboles de sécurité:

**Table 3** Description des Symboles de Sécurité qui pourraient apparaître sur le produit. (Sheet 1 of 2)

Symboles	Description
	Courant continu.
	Courant alternatif.
	Courant continu et alternatif.
	Courant alternative triphasé.
	Borne de terre (masse).
	Borne de terre de protection.
	Borne de terre reliée au cadre ou au châssis.
	Borne au potentiel de la terre.
	Equipotentialité
N	Conducteur neutre sur un équipement installé à demeure
L	Conducteur de phase sur un équipement installé à demeure.
	Alimentation en marche.
	Alimentation à l'arrêt.
	Alimentation en mode veille. Lorsque l'interrupteur est en mode veille, l'unité n'est pas complètement déconnectée de l'alimentation secteur.
	Position Marche d'un interrupteur par bouton poussoir bi-stable.
	Position Arrêt d'un interrupteur par bouton poussoir bi-stable.
	Appareil entièrement protégé par DOUBLE ISOLATION ou ISOLATION RENFORCÉE

**Table 3** Description des Symboles de Sécurité qui pourraient apparaître sur le produit. (Sheet 2 of 2)

Symboles	Description
	Attention. Consultez la documentation fournie.
	Attention, danger d'électrocution.
	Ne pas appliquer ou enlever sur des conducteurs SOUS TENSION DANGEREUSE
	Application ou retrait autorisés sur les conducteurs SOUS TENSION DANGEREUSE
	Attention, surface chaude
	Rayonnement ionisant
<b>CAT I</b>	Appareil de mesure de catégorie I selon la norme CEI applicable
<b>CAT II</b>	Appareil de mesure de catégorie II selon la norme CEI applicable
<b>CAT III</b>	Appareil de mesure de catégorie III selon la norme CEI applicable
<b>CAT IV</b>	Appareil de mesure de catégorie IV selon la norme CEI applicable



## Characteristics and Regulatory Information

The following tables provide the operating characteristics for the N2779A. There are no specifications.

**Table 4** N2779A Characteristics

Item	Characteristic
<b>OUTPUTS</b>	
Output voltage	DC $\pm 12\text{V} \pm 0.5\text{V}$
Number of probe-power connectors	3
Rated output current	$\pm 1.4\text{A}$
Ripple voltage	50 mV peak-to-peak or less (at rated output current)
Load coefficient	Within output voltage limits indicated above for current output in the range 0 to 1.4A
Temperature coefficient	Within output voltage limits indicated above for ambient temperature in the range 0 °C to 40 °C (32 °F to 104 °F)
<b>POWER REQUIREMENTS</b>	
Rated supply voltage	100 to 240 V <sub>AC</sub> (Voltage fluctuations of $\pm 10\%$ from the rated supply voltage are taken into account.)
Rated supply frequency	50/60 Hz
Maximum rated power consumption	130 VA
Installation category	CAT II (Line voltage in appliance and to wall outlet). Anticipated transient over voltage 2500V.
<b>GENERAL</b>	
Compatible sensors	Keysight N2780A/B, N2781A/B, N2782A/B, and N2783A/B current probes.
Weight	Approx 1.2 kg
External dimensions	Approx. Width 80 mm (3.1"), Height 119 mm (4.7") Depth 200 mm (7.9")
Accessories	Power cord
UL Listed	File No. E309995

**Table 4** N2779A Characteristics

Item	Characteristic
Compliant With	UL61010-1, CAN/CSA C22.2 No. 61010-1, EN61010-1

**Table 5** Environmental Characteristics

Item	Characteristic
Operating temperature and humidity range	0 °C to 40 °C (32 °F to 104 °F), 80% rh or less (no condensation)
Use	For indoor use only.
Storage temperature and humidity range	-10 °C to 50 °C (14 °F to 122 °F), 80% rh or less (no condensation)
Pollution degree	Pollution degree 2 For indoor use only
Altitude	Operating: up to 2000 m (6,562 ft)

Figure 2 shows the pin assignments for the front-panel probe power connectors.

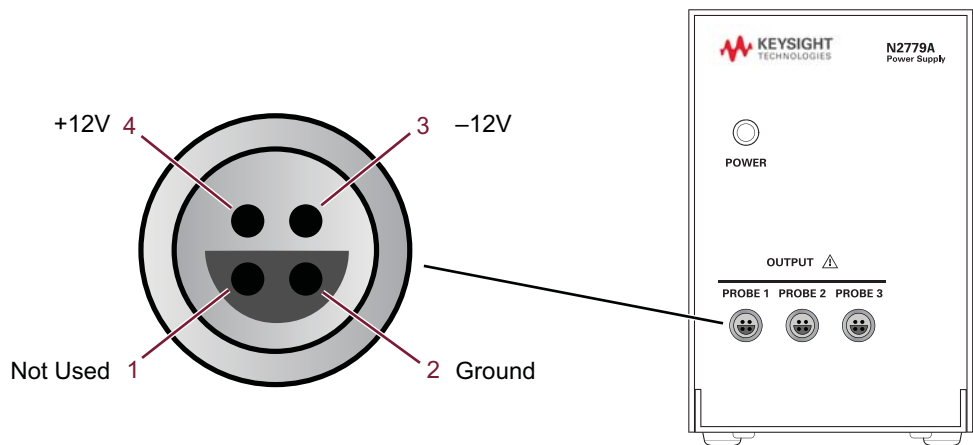

**Figure 2** Front-Panel Probe Power Pin Assignments

## Service

To return the probe to optimum performance requires factory repair. If the probe is under warranty, normal warranty services apply.

In the U.S., call (800) 829-4444 for further details and the location of your nearest Keysight service center. Outside the U.S., call your nearest Keysight sales office and ask them how to contact the nearest Keysight service center.

- 1** Write the following information on a tag and attach it to the power supply.
  - Name and address of the owner
  - Power supply model number
  - Description of service required or failure indications
- 2** Retain all accessories.
- 3** Return the power supply in its original shipping materials or pack the power supply in foam or other shock-absorbing material and place it in a strong shipping container. If the original shipping materials are not available, place 3 to 4 inches of shock-absorbing material around the instrument and place it in a box that does not allow movement during shipping.
- 4** Seal the shipping container securely.
- 5** Mark the shipping container as FRAGILE. In all correspondence, refer to the instrument by model number and full serial number.

Manual Part Number  
N2779-97005



Keysight Technologies  
Printed in Malaysia, September 2014