Keysight N2780/1/2/3B Current Probes

Notices

© Keysight Technologies, Inc. 2010 – 2015, 2017, 2022, 2023

No part of this manual may be reproduced in any form or by any means (including electronic storage and retrieval or translation into a foreign language) without prior agreement and written consent from Keysight Technologies, Inc. as governed by United States and international copyright laws.

Manual Part Number

N2780-97008

Edition

Edition 6, March 2023

Printed in Malaysia

Keysight Technologies, Inc.
1900 Garden of the Gods Road
Colorado Springs, CO 80907 USA

Warranty

The material contained in this document is provided "as is," and is subject to being changed, without notice, in future editions. Further, to the maximum extent permitted by applicable law, Keysight disclaims all warranties, either express or implied, with regard to this manual and any information contained herein, including but not limited to the implied warranties of merchantability and fitness for a particular purpose. Keysight shall not be liable for errors or for incidental or consequential damages in connection with the furnishing, use, or performance of this document or of any information contained herein. Should Keysight and the user have a separate written agreement with warranty terms covering the material in this document that conflict with these terms, the warranty terms in the separate agreement shall control.

Technology Licenses

The hardware and/or software described in this document are furnished under a license and may be used or copied only in accordance with the terms of such license.

U.S. Government Rights

The Software is "commercial computer software," as defined by Federal Acquisition Regulation ("FAR") 2.101. Pursuant to FAR 12.212 and 27.405-3 and Department of Defense FAR Supplement ("DFARS") 227.7202, the U.S. government acquires commercial computer software under the same terms by which the software is customarily provided to the public. Accordingly, Keysight provides the Software to U.S. government customers under its standard commercial license, which is embodied in its End User License Agreement (EULA), a copy of which can be found at <http://www.keysight.com/find/sweula>. The license set forth in the EULA represents the exclusive authority by which the U.S. government may use, modify, distribute, or disclose the Software. The EULA and the license set forth therein, does not require or permit, among other things, that Keysight: (1) Furnish technical information related to commercial computer software or commercial computer software documentation that is not customarily provided to the public; or (2) Relinquish to, or otherwise provide, the government rights in excess of these rights customarily provided to the public to use, modify, reproduce, release, perform, display, or disclose commercial computer software or commercial computer software documentation. No additional government requirements beyond those set forth in the EULA shall apply, except to the extent that those terms, rights, or licenses are explicitly required from all providers of commercial computer software pursuant to the FAR and the DFARS and are set forth specifically in writing elsewhere in the EULA. Keysight shall be under no obligation to update, revise or otherwise modify the Software. With respect to any technical data

as defined by FAR 2.101, pursuant to FAR 12.211 and 27.404.2 and DFARS 227.7102, the U.S. government acquires no greater than Limited Rights as defined in FAR 27.401 or DFAR 227.7103-5 (c), as applicable in any technical data.

Safety Notices

CAUTION

A **CAUTION** notice denotes a hazard. It calls attention to an operating procedure, practice, or the like that, if not correctly performed or adhered to, could result in damage to the product or loss of important data. Do not proceed beyond a **CAUTION** notice until the indicated conditions are fully understood and met.

WARNING

A **WARNING** notice denotes a hazard. It calls attention to an operating procedure, practice, or the like that, if not correctly performed or adhered to, could result in personal injury or death. Do not proceed beyond a **WARNING** notice until the indicated conditions are fully understood and met.

N2780/1/2/3B Current Probes

N2780/1B Current Probes	5
N2782/3B Current Probes	8
Making Measurements	10
Safe Probing	13
Safety Information	21
Informations relatives à la sécurité	25
Specifications and Characteristics	29
Performance Verification	43
Returning the Probe for Service	46

The N2780B series current probes are high bandwidth, active current probes, featuring flat bandwidth, low noise ($2.5 \text{ mA}_{\text{rms}}$) and low circuit insertion loss. In conjunction with the companion N2779A power supply, this probe can be used with any oscilloscope having a high-impedance BNC input. The N2779A (3 x 12 Vdc output) lets you connect up to any three N2780/1/2/3B current probes.

CAUTION Before using the probe, refer to “**Safe Probing**” on page 13 and “**Safety Information**” on page 21.

Inspecting the Probe

- Inspect the shipping container for damage.

Keep the damaged shipping container or cushioning material until the contents of the shipment have been checked for completeness and the probe has been checked mechanically and electrically.

- Check the accessories. If the contents are incomplete or damaged, notify your Keysight Technologies Sales Office.
- Inspect the probe. If there is mechanical damage or defect, or if the probe does not operate properly or pass calibration tests, notify your Keysight Technologies Sales Office.

If the shipping container is damaged, or the cushioning materials show signs of stress, notify the carrier as well as your Keysight Technologies Sales Office. Keep the shipping materials for the carrier's inspection. The Keysight Technologies office will arrange for repair or replacement at Keysight Technologies' option without waiting for claim settlement.

Cleaning the Probe

If the probe requires cleaning, disconnect it from the oscilloscope and clean it with a soft cloth dampened with a mild soap and water solution. Make sure the probe is completely dry before reconnecting it to the oscilloscope.

N2780/1B Current Probes

The following figure identifies the components of the N2780/1B probes.

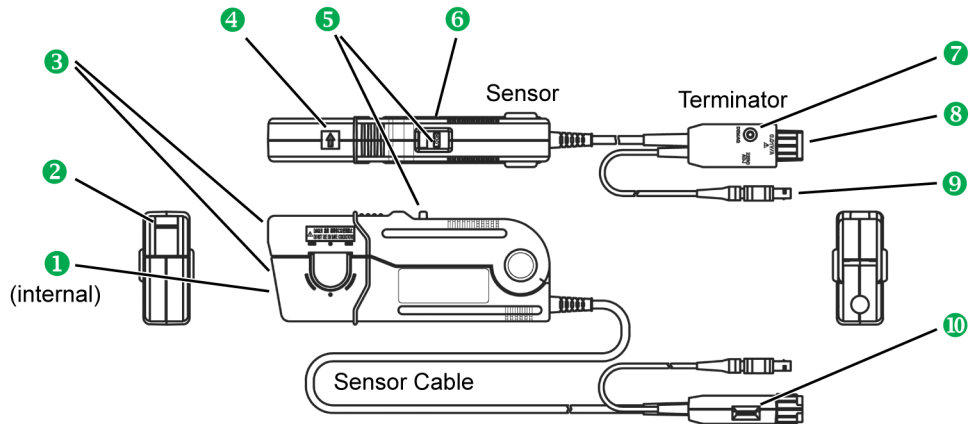

Figure 1 N2780/1B Probe Parts Identification

1 Sensor Head

Clamps the conductor being measured, and carries out the actual current measurement. It is a precision assembly including a molded component, a ferrite core, and a Hall effect element. It may be damaged if subjected to sudden changes in ambient temperature, or mechanical strain of shock, and therefore great care should be exercised in handling it.

2 Lock Mechanism

The lever lock mechanism keeps the clamp closed.

3 Clamp

Clamps around the conductor to be measured.

④ Current Direction Indication

Align the sensor so that the current direction indication corresponds to the direction of current flow through the conductor to be measured.

⑤ Opening Lever

Opens the clamp. Always use it to open and close the clamp.

⑥ LOCK/UNLOCK Indication

Indicates if the sensor head is closed or open.

⑦ Demagnetizing Switch (DEMAG)

This switch demagnetizes the core if it has been magnetized by switching the power on and off, or by an excessive input. Always carry out demagnetizing before a measurement. The demagnetizing process takes about 3 seconds. During demagnetizing, a demagnetizing waveform is output.

⑧ BNC Output Connector

Connect to the oscilloscope's BNC input connector. Turn the collar until it clicks, and check that it is locked securely.

NOTE The output of the current probe is terminated internally. You must select the input impedance of the oscilloscope to be 1 M Ω in order to make accurate measurements. If the oscilloscope you are using does not have a 1 M Ω input impedance setting you can purchase the E2697A 50 Ω to 1 M Ω adapter.

⑨ Power Supply Cable

Connect the power supply cable to the N2779A Power Supply receptacle to supply power to the sensor terminator.

10 Zero Adjustment Dial (ZERO ADJ)

Use the zero adjustment dial to correct for the effect of a voltage offset or temperature drift on the device. When beginning a measurement, after demagnetizing, always carry out a zero adjustment.

WARNING The raised ridge between the jaws and opening lever of the probe is purely decorative and not intended as a Protective Barrier. This is a Type D probe and should be used with insulated conductors only.

N2782/3B Current Probes

The following figure identifies the components of the N2782/3B probes.

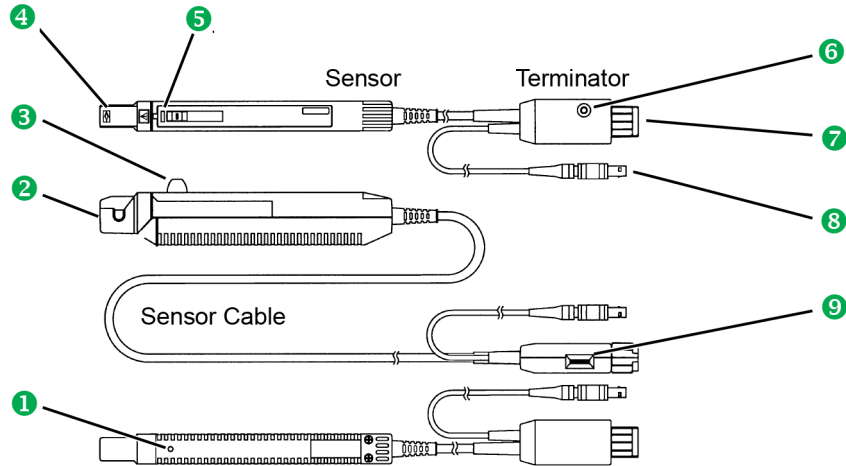

Figure 2 N2782/3B Probe Parts Identification

1 Coarse Adjustment Trimmer

This adjustment should only be carried out if the probe offset is outside the range of the zero adjustment dial.

2 Sensor Head

This clamps the conductor being measured, and carries out the actual current measurement. It is a precision assembly including a molded component, a ferrite core, and a Hall effect element. It may be damaged if subjected to sudden changes in ambient temperature, or mechanical strain or shock. Care should be exercised when handling the sensor head.

3 Opening Lever

Operating lever for opening the sensor head. Always use this lever to open the sensor head.

4 Current Direction Indication

Align the sensor so that the current direction indication corresponds to the direction of current flow through the conductor to be measured.

5 LOCK/UNLOCK Indication

Indicates if the sensor head is closed or open.

6 Demagnetizing Switch (DEMAG)

This demagnetizes the core if it has been magnetized by switching the power on and off, or by an excessive input. Always carry out demagnetizing before measurement. The demagnetizing process takes about one second. During demagnetizing, a demagnetizing waveform is output.

7 BNC Output Connector

Connect to the oscilloscope's BNC input connector. Turn the collar until it clicks, and check that it is locked securely.

NOTE The output of the current probe is terminated internally. You must select the input impedance of the oscilloscope to be 1 M Ω to make accurate measurements. If the oscilloscope you are using does not have a 1 M Ω input impedance setting you can purchase the E2697A 50 Ω to 1 M Ω adapter. The output resistance of probes is approximately 25 Ω (30A/50 MHz: N2782B-FG), 7 Ω (150A/10 MHz: N2781B-FG), 41 Ω (500A/2 MHz: N2780B-FG), 25 Ω (30A/100MHz: N2783B-FG).

8 Power Supply Cable

Connect this to the N2779A power supply receptacle to supply power to the sensor terminator.

9 Zero Adjustment Dial (ZERO ADJ)

Use the zero adjustment dial to correct for the effect of a voltage offset or temperature drift on the unit. The probe should be always be zeroed after demagnetization.

Making Measurements

WARNING Before using the probe, check that the system is safe and that the preparations described in “Safe Probing” on page 13 have been carried out.

CAUTION Before turning on the power, make sure that the voltage of the power supply being used matches the supply voltage indicated on the N2779A’s rear panel.

- 1 On the N2779A power supply, turn the power switch off and connect the power cord.
- 2 Connect the probe’s power plug to the N2779A’s power receptacle.
- 3 Turn the N2779A power switch on, and check that the front-panel power indicator lights.

Demagnetization and Zero Adjustment

NOTE The output of the current probe is terminated internally. Use a high impedance input to the measuring instrument. Accurate measurements are not possible when the input impedance of the oscilloscope is set to 50Ω . Be sure to set the input impedance to $1\text{ M}\Omega$ before making measurements. If the oscilloscope input impedance cannot be set to $1\text{ M}\Omega$ then the Keysight E2697A impedance adapter can be purchased.

- 4 With the oscilloscope input at ground, adjust the trace to the zero position.
- 5 Set the oscilloscope’s input coupling to DC.
- 6 Connect the probe’s output connector to the oscilloscope’s input connector as shown in **Figure 3** on page 11. Turn the collar until it clicks, and check that it is locked securely.

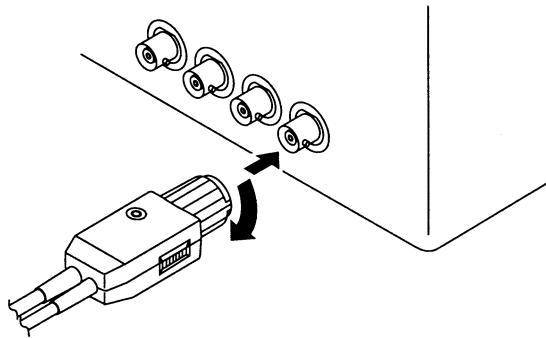

Figure 3 Connecting the Probe to the Oscilloscope

CAUTION When disconnecting the output connector, be sure to release the lock, then pull the connector. Forcibly pulling the connector without releasing the lock, or pulling on the cable will result in damage to the terminator.

CAUTION Do not demagnetize while the conductor being measured is clamped. This could damage the components of the circuit being measured. Also, check that the conductor being measured is not clamped when supplying power to the current probe for the same reason. Demagnetized waveforms are generated when switching on the supply.

- 7 Ensure that the probe sensor is NOT clamped around any conductors.
- 8 Slide the probe's Opening Lever into the **LOCKED** position as shown in **Figure 4**. Confirm that the sensor head is properly closed.

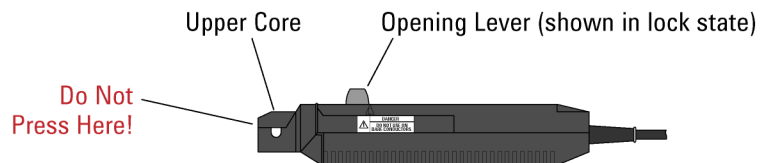

Figure 4 Use of Opening Lever

- 9 Press the probe's demagnetizing switch (**DEMAG**).
- 10 Turn the probe's zero adjustment dial to adjust the trace to the zero position.

NOTE N2782/3B probes have a coarse adjustment trimmer. If zero adjustment is not possible on an N2782/3B probe, turn the coarse adjustment trimmer to bring the trace within the range of adjustment by the zero adjustment dial. See **Figure 2** on page 8 for the location of the coarse adjustment trimmer. To avoid damaging the trimmer, do not force too much while adjusting it. Use a screwdriver made of non-conductive material such as ceramic, preferably with a flathead tip, 0.4 mm thick, 1.8 mm wide, and 10 mm or longer in length.

Measurement

WARNING Check that the system is safe and that the preparations described in “Safe Probing” on page 13 have been carried out.

- 11 Press the opening lever to open the sensor head.
- 12 Align the sensor so that the probe's current direction indication corresponds to the direction of current flow through the conductor to be measured. Also, align the clamp so that the conductor is in the center of the sensor aperture.
- 13 Press the opening lever on the sensor head until the **UNLOCK** indication disappears. Check that the opening lever is firmly locked and the sensor head securely closed.
- 14 If you are using an N2780/1B current probe, set the oscilloscope to the following settings:
 - Input Impedance: 1 M Ω
 - Attenuation Ratio: 100:1
 - Units:Amperes
- 15 If you are using an N2782/3B current probe, set the oscilloscope to the following settings:
 - Input Impedance: 1 M Ω
 - Attenuation Ratio: 10:1
 - Units:Amperes

Safe Probing

This device is designed to comply with IEC 61010 Safety Standards, and has been thoroughly tested for safety prior to shipment. However, mishandling during use could result in injury or death, as well as damage to the device. Be certain that you understand the instructions and precautions in the manual before use. We disclaim any responsibility for accidents or injuries not resulting directly from device defects.

To avoid short circuits and potentially life-threatening hazards, follow these warnings and precautions:

WARNING To prevent fire or damage of the measurement target and device as well as burns, exercise caution concerning the following when measuring high-frequency currents or currents that contain high-frequency components:

- Eddy current loss may cause heating of the sensor head.
- Dielectric heating may cause heating of cord insulation and other materials.
- This device should only be connected to the secondary side of a breaker, so the breaker can prevent an accident if a short circuit occurs. Connections should never be made to the primary side of a breaker, because unrestricted current flow could cause a serious accident if a short circuit occurs.

WARNING Clamping around bare conductors is not permitted.

WARNING Take measurements at a location on an insulated wire where there is sufficient insulation for the circuit voltage.

WARNING Be careful to avoid damaging the insulation surface while taking measurements.

WARNING Do not allow the device to get wet, and do not take measurements with wet hands. This may cause an electric shock.

WARNING Read and observe all warnings and precautions relating to electrical safety for the measuring instrument being connected to the probe.

Observe the following warnings to avoid electric shock and short circuits.

WARNING Connect the device to the Model N2779A Power Supply and waveform measurement instrument (oscilloscope or recorder) first, and then to the active lines to be measured.

WARNING When the sensor is opened, do not shortcircuit the conductor being measured or other two wires with the metal part of the tip.

WARNING Read and observe all warnings and precautions relating to electrical safety for the measuring instrument being connected to the probe.

WARNING To avoid electric shock when measuring live lines, wear appropriate protection gear, such as insulated rubber gloves, boots, and a safety helmet.

WARNING If the equipment is used in a manner not specified by the manufacturer, the protection provided by the equipment may be impaired.

CAUTION To avoid damage to the device, protect it from vibration or shock during transport and handling, and be especially careful to avoid dropping.

CAUTION Do not store or use the device where it could be exposed to direct sunlight, high temperature, humidity, or condensation. Under such conditions, the device may be damaged and insulation may deteriorate so that it no longer meets specifications.

CAUTION Before using the device the first time, verify that it operates normally to ensure that no damage occurred during storage or shipping. If you find any damage, contact your dealer or Keysight representative.

CAUTION This device is not designed to be entirely water- or dust- proof. To avoid damage, do not use it in a wet or dusty environment.

CAUTION The sensor head is a precision assembly including a molded component, a ferrite core, and a Hall effect element. It may be damaged if subjected to sudden changes in ambient temperature, or mechanical strain or shock, and therefore great care should be exercised in handling it.

CAUTION The matching surfaces of the sensor head are precision ground, and should be treated with care. If these surfaces are scratched, performance may be impaired.

CAUTION Foreign substances such as dust on the contact surfaces of the sensor head can cause acoustic resonance and degrade measurement, so it should be cleaned by gently wiping with a soft cloth.

CAUTION To avoid damaging the sensor cable and power supply cable, do not bend or pull the cables.

CAUTION Do not apply a static electricity or other source of high voltage to the sensor. Doing so may damage its internal Hall elements and circuitry.

CAUTION Avoid stepping on or pinching the cable, which could damage the cable insulation.

CAUTION Keep the cable well away from heat sources, as bare conductors could be exposed if the insulation melts.

CAUTION When the power is on, keep closed, except when clamping them onto the conductor to be measured. The facing surface of the core section can be scratched while it is open.

CAUTION

Do not place any un-clamped conductor with an electric current of a frequency of 10 kHz or more near the sensor head. Current flowing in the conductor nearby may heat up the sensor head and cause its temperature to rise, leading to damage to the sensor. For example, when one side of a go-and-return conductor is clamped and the other side is also placed near the sensor head (as shown in **Figure 5** on page 16), even if the electric current is lower than the consecutive maximum current, electric currents in both sides will heat up the wires and raise the temperature, thereby causing damage to the sensor.

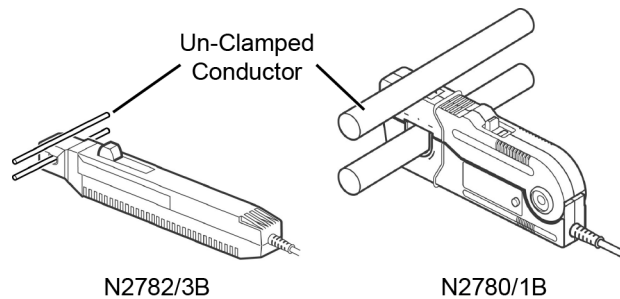

Figure 5 Avoid Un-Clamped Conductor Near Sensor Head

CAUTION

The maximum continuous input range is based on heat that is internally generated during measurement. Never input current in excess of this level. Exceeding the rated level may result in damage to the probe.

CAUTION

The maximum continuous input range varies according to the frequency of the current being measured. See **Figure 9** on page 33, **Figure 14** on page 35, **Figure 19** on page 38, and **Figure 24** on page 40.

CAUTION The device may sustain damage from self-heating even at current levels that are lower than the maximum current value defined by the maximum rated current. The maximum rated current is a recommended value that assumes sine wave input under standard conditions. Self-heating may increase if the ambient temperature increases or the measurement current waveform contains other frequency components. Refer to the derating characteristics in the product specifications.

CAUTION Current measurement exceeding approximately 1 kHz may result in temperature rise on the sensor head. This is attributed to excitation loss that cannot be prevented due to natural physical principles.

CAUTION Be careful to avoid injury, electric shock due to short circuits, or damage to the device that may be caused by the increased temperature.

CAUTION If excess current is input, generated heat activates a built-in safety function that blocks normal output. If this happens, remove the input immediately (remove the sensor from the conductor being measured or reduce the input current to zero). Wait until the sensor has had sufficient time to cool before resuming operation.

CAUTION Even if the input current does not exceed the rated continuous maximum, continuous input for an extended period of time may result in activation of the safety circuit to prevent damage resulting from heating of the sensor.

CAUTION At high ambient temperatures, the built-in safety circuit may activate at current input levels below the rated continuous maximum.

CAUTION Continuous input of current exceeding the rated maximum or repeated activation of the safety function may result in damage to the unit.

CAUTION The N2781B probe is rated for maximum input under two conditions in addition to the input maximums shown in the “**Specifications and Characteristics**” on page 29. These are (1) $300 A_{\text{peak}}$ for noncontinuous input and (2) $500 A_{\text{peak}}$ for pulse widths $30 \mu\text{s}$. (1) indicates an upper waveform response limit of $30 A_{\text{peak}}$. Use the sensor at RMS current input levels that are within the rated continuous maximums. (2) indicates the upper response limit for a single input pulse.

CAUTION When opening the sensor head of the probe, be sure to operate with the opening lever. If an upper core is forced to open when the sensor head is locked, the open-close mechanism can be damaged. See **Figure 6**.

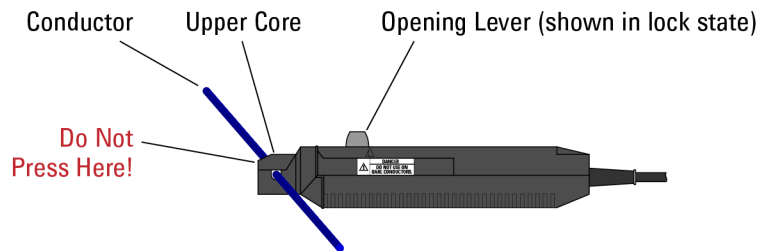

Figure 6 Use the Opening Lever

NOTE The output of this unit is terminated internally. Use an oscilloscope with an input impedance of at least $1 M\Omega$ or use the Keysight E2697A impedance adapter.

NOTE Immediately after powering on the probe, the probe may be subject to an appreciable offset drift due to the effect of self-heating. To counteract this, allow the probe to warm up for about 30 minutes before carrying out measurement.

NOTE When performing continuous measurements, it is necessary to be aware that the offset voltage drifts, depending on factors such as the ambient temperature.

NOTE	Under certain circumstances, oscillation may occur if the probe is connected to the N2779A power supply while the power supply is on. This does not indicate a malfunction. Oscillation can be stopped and operation restored to normal by opening and closing the sensor head.
NOTE	Depending on the amplitude and frequency of the current being measured, the sensor head may emit a resonant sound. This sound may also occur during a demagnetizing operation, but it does not represent a malfunction (device failure).
NOTE	If foreign matter becomes adhered to the facing surfaces on the sensor head so that a slight gap exists between the upper and lower sensors, the sensor head may emit a resonant sound. Any foreign matter should be removed using the cleaning method described in this manual.
NOTE	An increase in the volume of the resonant sound during use may indicate that the gap between the upper and lower sensors has increased in size. Since the sensor characteristics may change, it is recommended to calibrate the device. (See “Returning the Probe for Service” .)
NOTE	The reading may be affected by the position within the clamp aperture of the conductor being measured. The conductor should be in the center of the clamp aperture.
NOTE	When carrying out a measurement, press the opening lever until the UNLOCK indication disappears and check that the sensor head is properly closed. If the sensor head is not properly closed, an accurate measurement is not possible.
NOTE	Accurate measurement may be impossible in locations subject to strong external magnetic fields, such as transformers and high-current conductors, or in locations subject to strong external electric fields, such as radio transmission equipment.

NOTE At high frequencies, common mode noise may affect measurements taken on the high voltage side of circuits. If this occurs, reduce the frequency range of the waveform measuring instrument or clamp onto the low-voltage side of the circuit, as appropriate. See [Figure 7](#) on page 20. Although the figure shows an N2782/3B probe, the same technique is used with an N2780/1B probe.

NOTE During demagnetization, the demagnetization waveform (a waveform that attenuates over time) will be output from the device's output connector and displayed on the waveform measurement instrument. The positive and negative components of this waveform may be asymmetrical, but this does not represent a device malfunction.

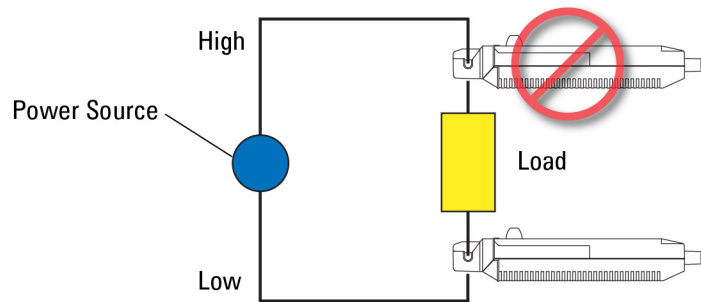

Figure 7 Clamp Onto the Low-Voltage Side of Circuit (Shown with N2782B)

Safety Information

The following general safety precautions must be observed during all phases of operation of this instrument. Failure to comply with these precautions or with specific warnings or operating instructions in the product manuals violates safety standards of design, manufacture, and intended use of the instrument. Keysight Technologies assumes no liability for the customer's failure to comply with these requirements. Product manuals are provided with your instrument on CD-ROM and/or in printed form. Printed manuals are an option for many products. Manuals may also be available on the Web. Go to www.keysight.com and type in your product number in the Search field at the top of the page.

General

Do not use this product in any manner not specified by the manufacturer. The protective features of this product may be impaired if it is used in a manner not specified in the operation instructions.

Before Applying Power

Verify that all safety precautions are taken. Make all connections to the unit before applying power. Note the instrument's external markings described in **Table 1** on page 23.

Ground the Instrument

If your product is provided with a grounding type power plug, the instrument chassis and cover must be connected to an electrical ground to minimize shock hazard. The ground pin must be firmly connected to an electrical ground (safety ground) terminal at the power outlet. Any interruption of the protective (grounding) conductor or disconnection of the protective earth terminal will cause a potential shock hazard that could result in personal injury.

Fuses

See the user's guide or operator's manual for information about line-fuse replacement. Some instruments contain an internal fuse, which is not user accessible.

Do Not Operate in an Explosive Atmosphere

Do not operate the instrument in the presence of flammable gases or fumes.

Do Not Remove the Instrument Cover

Only qualified, service-trained personnel who are aware of the hazards involved should remove instrument covers. Always disconnect the power cable and any external circuits before removing the instrument cover.

Cleaning

Clean the outside of the instrument with a soft, lint-free, slightly dampened cloth. Do not use detergent or chemical solvents.

Do Not Modify the Instrument

Do not install substitute parts or perform any unauthorized modification to the product. Return the product to an Keysight Sales and Service Office for service and repair to ensure that safety features are maintained.

In Case of Damage

Instruments that appear damaged or defective should be made inoperative and secured against unintended operation until they can be repaired by qualified service personnel.

CAUTION A CAUTION notice denotes a hazard. It calls attention to an operating procedure, practice, or the like that, if not correctly performed or adhered to, could result in damage to the product or loss of important data. Do not proceed beyond a CAUTION notice until the indicated conditions are fully understood and met.

WARNING A WARNING notice denotes a hazard. It calls attention to an operating procedure, practice, or the like that, if not correctly performed or adhered to, could result in personal injury or death. Do not proceed beyond a WARNING notice until the indicated conditions are fully understood and met.

Safety Symbols

Table 1 Description of Safety related symbols that may appear on a product (Sheet 1 of 2)



















Symbol	Description
	Direct current
	Alternating current
	Both direct and alternating current
	Three phase alternating current
	Earth ground terminal
	Protective earth ground terminal
	Frame or chassis ground terminal
	Terminal is at earth potential
	Equipotentiality
N	Neutral conductor on permanently installed equipment
L	Line conductor on permanently installed equipment
	On (mains supply)
○	Off (mains supply)
	Standby (mains supply). The instrument is not completely disconnected from the mains supply when the power switch is in the standby position
	In position of a bi-stable push switch
	Out position of a bi-stable push switch
	Equipment protected throughout by DOUBLE INSULATION or REINFORCED INSULATION

Table 1 Description of Safety related symbols that may appear on a product (Sheet 2 of 2)

Symbol	Description
	Caution, refer to accompanying documentation
	Caution, risk of electric shock
	Indicates that only insulated conductors suited to the voltage of the circuit under test can be measured.
	Application around and removal from HAZARDOUS LIVE conductors is permitted.
	Caution, hot surface
	Ionizing radiation

Informations relatives à la sécurité

Les consignes de sécurité générales présentées dans cette section doivent être appliquées au cours des différentes phases d'utilisation de cet appareil. Le non-respect de ces précautions ou des avertissements et consignes d'utilisation spécifiques mentionnés dans les manuels des produits constitue une violation des normes de sécurité relatives à la conception, à la fabrication et à l'usage normal de l'instrument. Keysight Technologies ne saurait être tenu responsable du non-respect de ces consignes. Les manuels des produits sont fournis avec votre instrument sur CD-ROM et/ou en version papier. Les versions papier des manuels sont en option pour de nombreux produits. Certains manuels sont également disponibles en ligne. Pour y accéder, allez sur le site www.keysight.com et saisissez la référence de votre produit dans le champ Rechercher qui se trouve en haut de la page.

Généralités

Utilisez ce produit uniquement dans le cadre prévu par le fabricant. Si vous ne respectez pas les instructions d'utilisation, les fonctions de sécurité du produit risquent d'être inhibées.

Avant la mise sous tension

Vérifiez que vous avez bien respecté toutes les consignes de sécurité. Faites tous les branchements au niveau de l'appareil avant de mettre ce dernier sous tension. Tenez compte des marquages externes à l'instrument décrits à la section « Symboles de sécurité ».

Mise à la terre de l'instrument

Si une prise de mise à la terre est fournie avec le produit, le châssis et le capot de l'instrument doivent être reliés à la terre afin de limiter les risques d'électrocution. Le contact à la terre doit être solidement connecté à une borne de terre (de sécurité) au niveau de la prise de courant. Toute interruption du conducteur de protection (mise à la terre) ou tout débranchement de la borne de terre de protection donne lieu à un risque d'électrocution pouvant entraîner des blessures graves.

Fusibles

Pour obtenir des instructions sur le changement des fusibles de ligne, consultez le guide de l'utilisateur ou le manuel d'instructions. Certains instruments comportent un fusible interne inaccessible à l'utilisateur.

Ne pas utiliser en atmosphère explosive

N'utilisez pas l'instrument en présence de gaz ou de vapeurs inflammables.

Ne pas démonter le capot de l'instrument

Seules des personnes qualifiées, formées à la maintenance et conscientes des risques d'électrocution encourus sont autorisées à démonter les capots de l'instrument.

Débranchez toujours le cordon d'alimentation secteur et tous les circuits externes avant de démonter le capot de l'instrument.

Nettoyage

Nettoyez la partie externe de l'instrument à l'aide d'un chiffon doux et non pelucheux, légèrement humidifié. N'utilisez pas de détergents ou de solvants chimiques.

Ne pas modifier l'instrument

N'installez pas de composants de remplacement et n'apportez aucune modification non autorisée à l'appareil. Pour toute opération de maintenance ou de réparation, renvoyez l'appareil à un bureau de vente et de service après-vente Keysight, afin d'être certain que les fonctions de sécurité seront maintenues.

En cas de dommages

Les instruments endommagés ou défectueux doivent être désactivés et protégés contre toute utilisation involontaire jusqu'à ce qu'ils aient été réparés par une personne qualifiée.

ATTENTION

La mention ATTENTION indique un risque. Si la manoeuvre ou le procédé correspondant n'est pas exécuté correctement, il peut y avoir un risque de dommages à l'appareil ou de perte de données importantes. En présence de la mention ATTENTION, il convient de s'interrompre tant que les conditions indiquées n'ont pas été parfaitement comprises et respectées.

AVERTISSEMENT

La mention AVERTISSEMENT signale un danger pour la sécurité de l'opérateur. Si la manoeuvre ou le procédé correspondant n'est pas exécuté correctement, il peut y avoir un risque pour la santé des personnes. En présence d'une mention AVERTISSEMENT, il convient de s'interrompre tant que les conditions indiquées n'ont pas été parfaitement comprises et respectées.

Symboles de sécurité:

Table 2 Description des Symboles de Sécurité qui pourraient apparaître sur le produit. (Sheet 1 of 2)



















Symboles	Description
	Courant continu.
	Courant alternatif.
	Courant continu et alternatif.
	Courant alternative triphasé.
	Borne de terre (masse).
	Borne de terre de protection.
	Borne de terre reliée au cadre ou au châssis.
	Borne au potentiel de la terre.
	Equipotentialité
N	Conducteur neutre sur un équipement installé à demeure
L	Conducteur de phase sur un équipement installé à demeure.
	Alimentation en marche.
○	Alimentation à l'arrêt.
	Alimentation en mode veille. Lorsque l'interrupteur est en mode veille, l'unité n'est pas complètement déconnectée de l'alimentation secteur.
	Position Marche d'un interrupteur par bouton poussoir bi-stable.
	Position Arrêt d'un interrupteur par bouton poussoir bi-stable.
	Appareil entièrement protégé par DOUBLE ISOLATION ou ISOLATION RENFORCÉE

Table 2 Description des Symboles de Sécurité qui pourraient apparaître sur le produit. (Sheet 2 of 2)

Symboles	Description
	Attention. Consultez la documentation fournie.
	Attention, danger d'électrocution.
	Ne pas appliquer ou enlever sur des conducteurs SOUS TENSION DANGEREUSE
	Application ou retrait autorisés sur les conducteurs SOUS TENSION DANGEREUSE
	Attention, surface chaude
	Rayonnement ionisant

Specifications and Characteristics

Table 3 lists specifications are guaranteed. **Table 4** lists the characteristics, which are non-warranted.

Table 3 Specifications (Warranted)

	N2780B	N2781B	N2782B	N2783B
Amplitude accuracy (DC or 45 to 66 Hz, up to maximum continuous current)	±1.0% of reading ±500 mA at 23 °C ± 3 °C	±1.0% of reading ±100 mA at 23 °C ± 3 °C	±1.0% of reading ±10 mA at 23 °C ± 3 °C	±1.0% of reading ±10 mA at 23 °C ± 3 °C

Table 4 Characteristics (Non-Warranted) (Sheet 1 of 2)



	N2780B	N2781B	N2782B	N2783B
Bandwidth	DC to 2 MHz (-3 dB) <i>(Typical characteristic shown in Figure 8)</i>	DC to 10 MHz (-3 dB) <i>(Typical characteristic shown in Figure 13)</i>	DC to 50 MHz (-3 dB) <i>(Typical characteristic shown in Figure 18)</i>	DC to 100 MHz (-3 dB) <i>(Typical characteristic shown in Figure 23)</i>
Rise Time	175 ns or less	35 ns or less	7 ns or less	3.5 ns or less
 Maximum Current (continuous) rms	500 A _{rms} (Derating according to frequency shown in Figure 9)	150 A _{rms} (Derating according to frequency shown in Figure 14)	30 A _{rms} (Derating according to frequency shown in Figure 19)	30 A _{rms} (Derating according to frequency shown in Figure 24)
 Maximum Peak Current value (non-continuous)	700 A _{peak} at pulse width ≤ 30 μs	500 A _{peak} at pulse width ≤ 30 μs	50 A _{peak} at pulse width ≤ 10 μs	
Output Voltage Rate	0.01 V/A (100:1)		0.1 V/A (10:1)	
Noise (for 20 MHz band measuring instrument)	Equivalent to 25 mA _{rms} or less		Equivalent to 2.5 mA _{rms} or less	
Input Impedance <i>(Typical characteristics)</i>	See Figure 10	See Figure 15	See Figure 20	See Figure 25

Table 4 Characteristics (Non-Warranted) (Sheet 2 of 2)

	N2780B	N2781B	N2782B	N2783B
Temperature coefficient for sensitivity (within a range of 0 °C to 40 °C or 32 °F to 104 °F)	± 2% or less			
Effect of external magnetic fields (in a DC or 60 Hz, 400 A/m magnetic field)	Equivalent to a maximum of 800 mA	Equivalent to a maximum of 150 mA	Equivalent to a maximum of 20 mA	Equivalent to a maximum of 5 mA
Maximum rated power (with rated current)	7.2 VA	5.5 VA	5.6 VA	5.3 VA
Lowest Measurable Current ^a (at 3% accuracy of DC current with the oscilloscope set to 1 mV/div and high resolution mode on.)	20 mA		5 mA	
Rated Supply Voltage	DC ± 12V ± 0.5V	DC ± 12V ± 1 V	DC ± 12V ± 0.5 V	DC ± 12V ± 0.5V

a Oscilloscope set to 1 mV/div and 20 MHz or 25 MHz bandwidth limited.

Table 5 General Characteristics

	N2780B	N2781B	N2782B	N2783B
Diameter of measurable conductors	20 mm (0.79")		5 mm (0.2")	
Cable Lengths (Approximate)				
Sensor	2m (78.7")		1.5m (59")	
Power supply	1m (39.4")		1m (39.4")	
External Sensor Dimensions (Approximate)				
Width	176 mm (6.93")		175 mm (6.89")	
Height	69 mm (2.72")		18 mm (0.71")	
Depth	27 mm (1.06")		40 mm (1.57")	
External Terminator Dimensions				
Width	27 mm (1.06")			
Height	55 mm (2.17")			
Depth	18 mm (0.71")			
Weight (Approximate)	520 g (18.3 oz.)	500 g (17.6 oz.)	230 g (8.1 oz.)	240 g (8.5 oz.)

Table 6 Environmental Specifications (Sheet 1 of 2)

Item	Specification
Operating temperature and humidity range	0 °C to 40 °C (32 °F to 104 °F) 80 %rh or less (no condensation)
Storage temperature and humidity range	-10 °C to 50 °C (14 °F to 122 °F) 80 %rh or less (no condensation)
Bearable storage vibration	1. Vibration 10 to 55 Hz, 30 min per axis, 1 octave/min sweep rate, Amplitude 0.3 mm 2. Vibration 55 Hz, 30 min per axis, Amplitude 0.3 mm, Vibration acceleration 17.91 m/s ²
Altitude	Operating up to 2,000 m (6,562 ft)

Table 6 Environmental Specifications (Sheet 2 of 2)

Item	Specification
Pollution degree	Pollution degree 2 For indoor use only
Measurable conductors	Insulated conductor

N2780B Plots

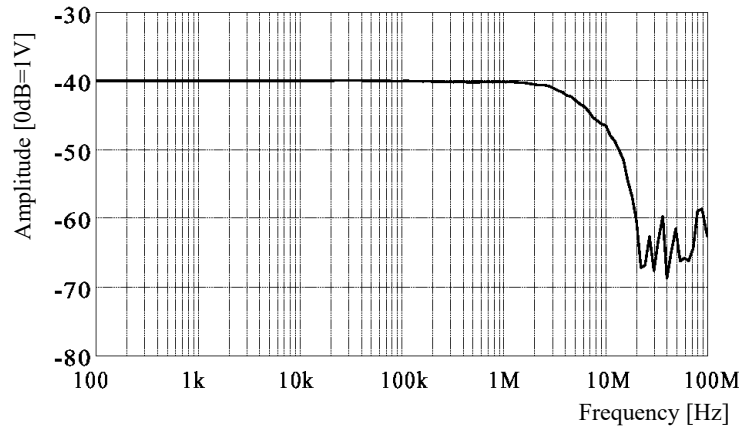

Figure 8 Frequency Response Characteristic N2780B

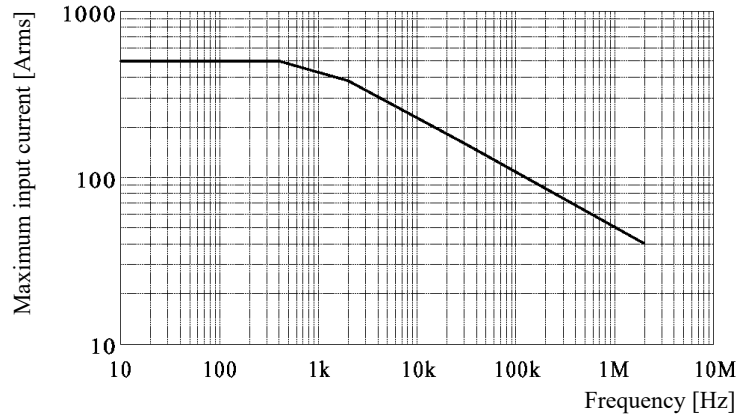

Figure 9 Derating According to Frequency N2780B (Continuous Maximum Input)

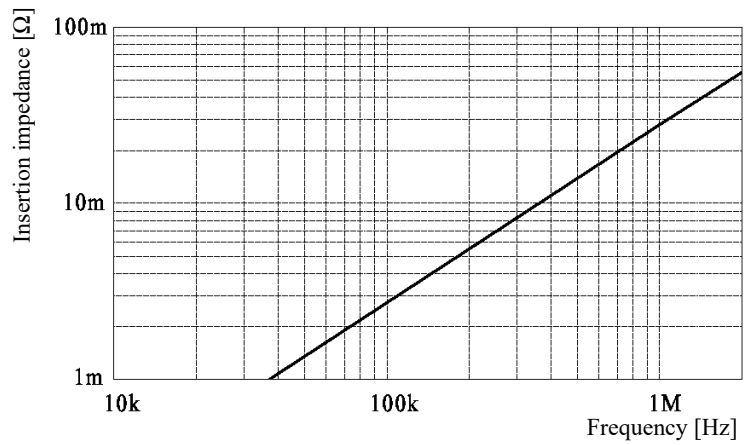

Figure 10 Insertion Impedance N2780B

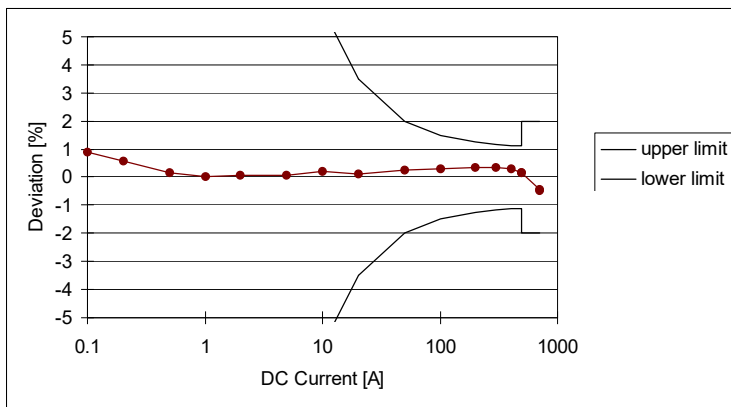

Figure 11 DC Accuracy Characteristic N2780B

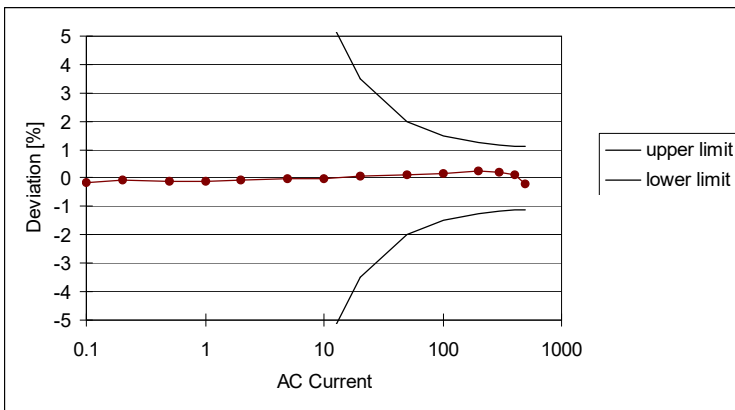

Figure 12 AC Amplitude Accuracy Characteristic N2780B

N2781B Plots

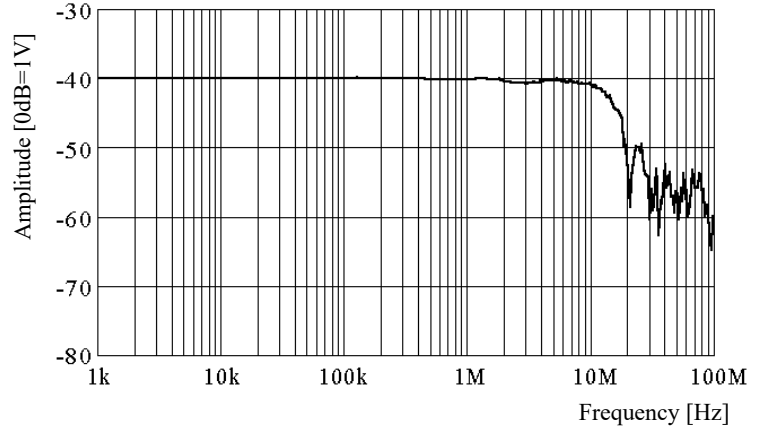

Figure 13 Frequency Response Characteristic N2781B

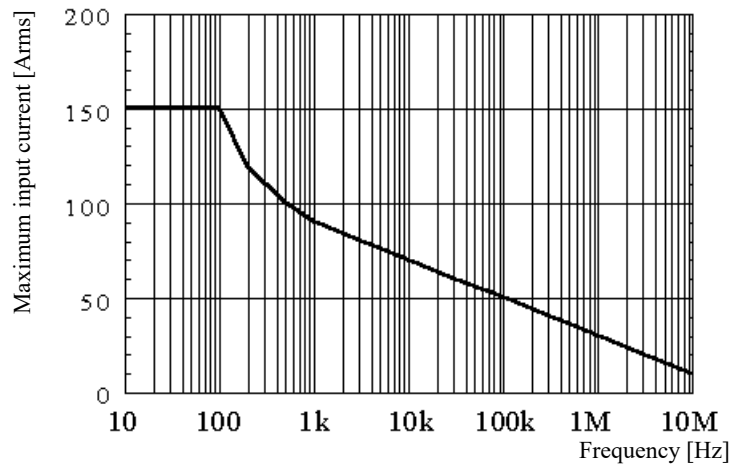

Figure 14 Derating According to Frequency N2781B (Continuous Maximum Input)

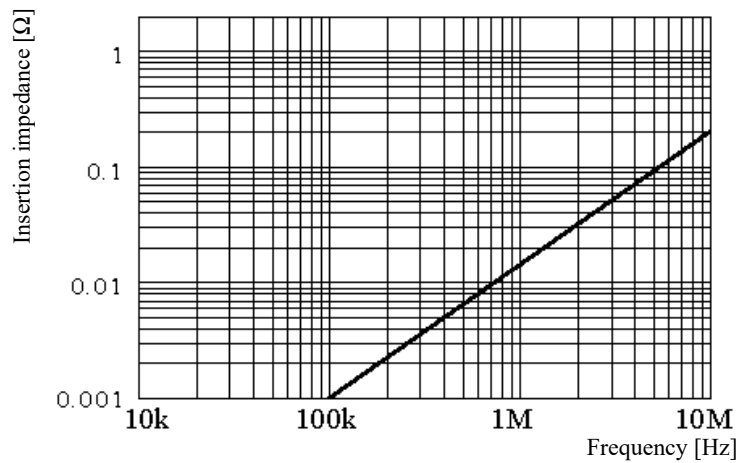

Figure 15 Insertion Impedance N2781B

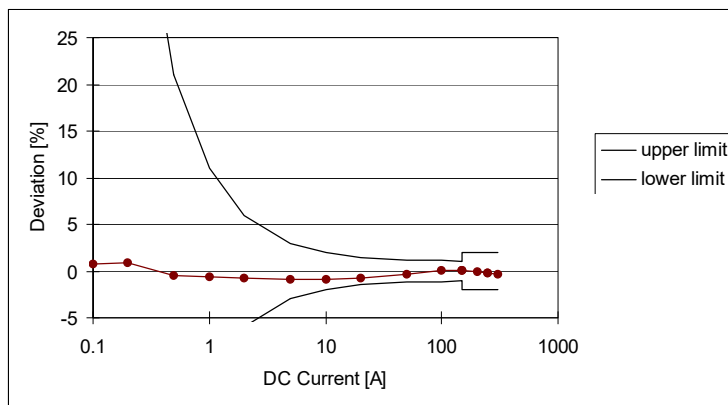

Figure 16 DC Accuracy Characteristic N2781B

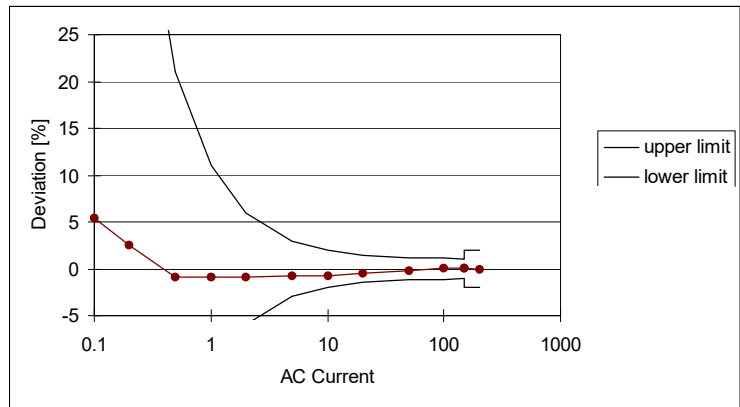

Figure 17 AC Amplitude Accuracy Characteristic N2781B

N2782B Plots

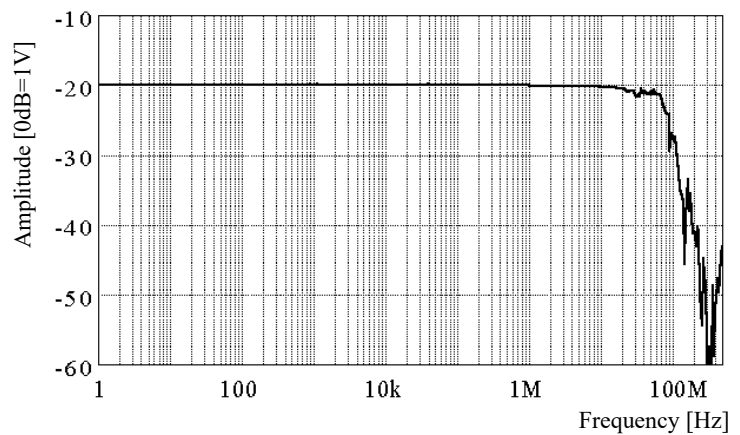

Figure 18 Frequency Response Characteristic N2782B

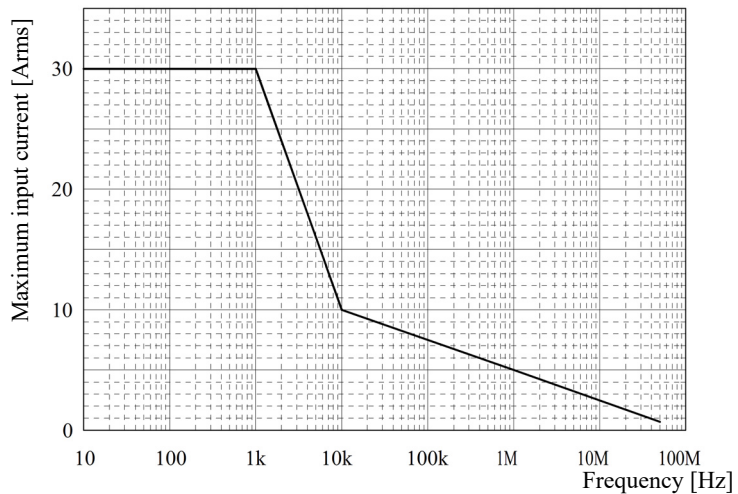

Figure 19 Derating According to Frequency N2782B (Continuous Maximum Input)

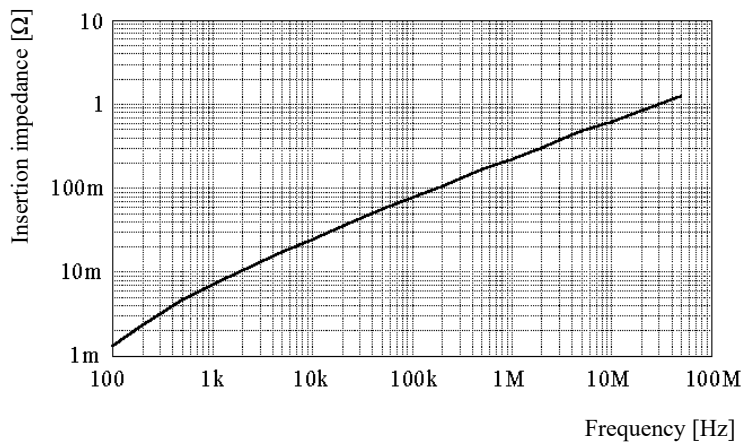

Figure 20 Insertion Impedance N2782B

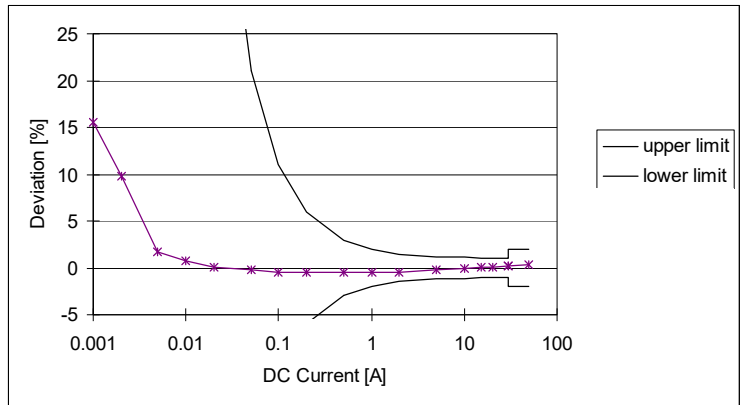

Figure 21 DC Accuracy Characteristic N2782B

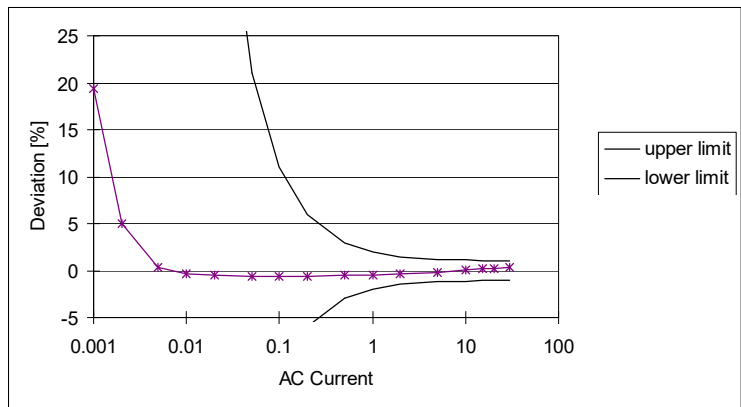

Figure 22 AC Amplitude Accuracy Characteristic N2782B

N2783B Plots

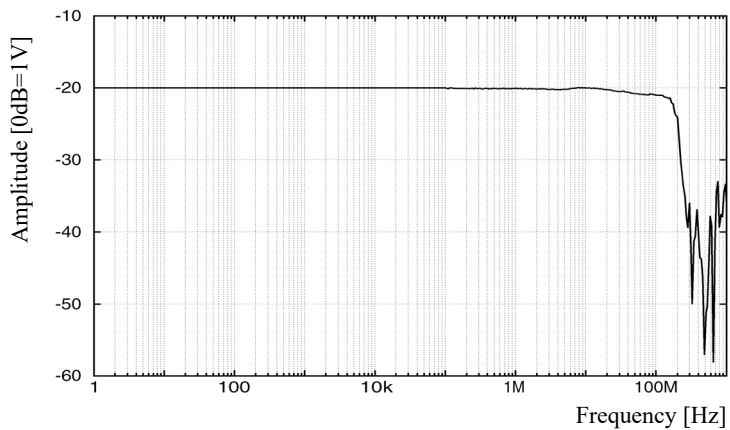

Figure 23 Frequency Response Characteristic N2783B

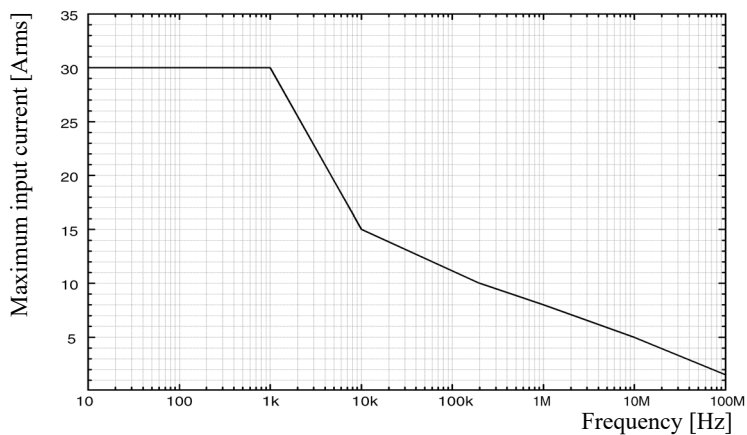

Figure 24 Derating According to Frequency N2783B (Continuous Maximum Input)

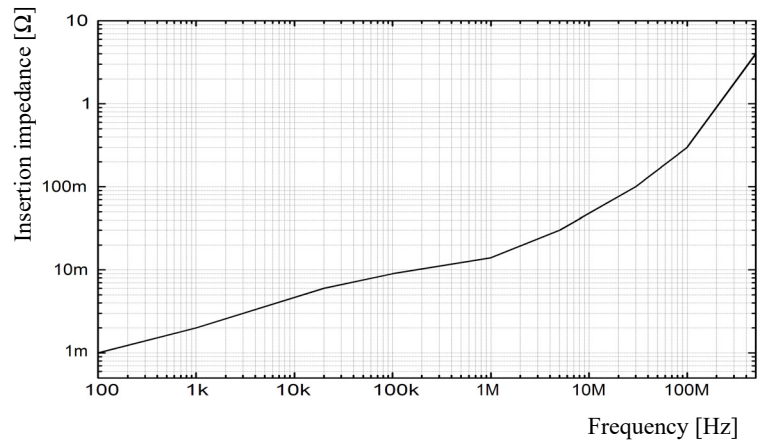

Figure 25 Insertion Impedance N2783B

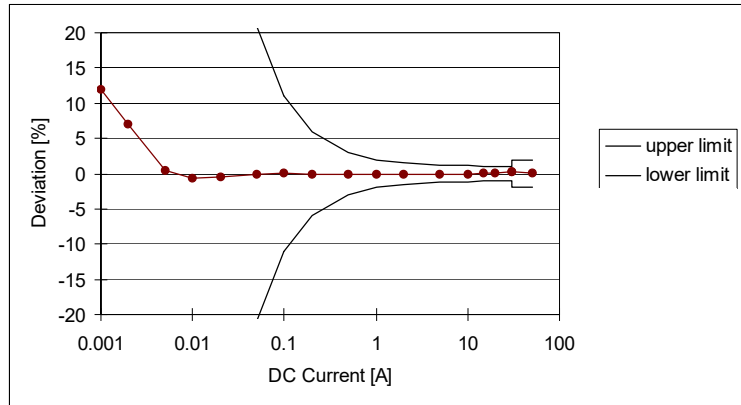

Figure 26 DC Accuracy Characteristic N2783B

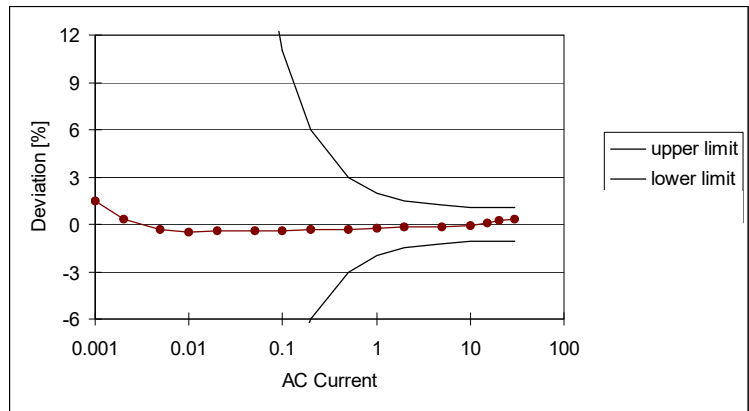

Figure 27 AC Amplitude Accuracy Characteristic N2783B

Performance Verification

The procedure in this section measures the accuracy of the current probe.

Table 7 Required Test Equipment

Description	Critical Specifications	Recommended
Probe Power Supply	No substitute	Keysight N2779A
Digital Multimeter (DMM)	AC/DC voltage and current measurement accuracy better than $\pm 0.1\%$ of reading at 10 mA Input resistance in AC/DC voltage mode $\geq 1 \text{ M}\Omega$	Keysight 34401A
Signal Generator	DC to 66 Hz sine waves able to generate more than 10A in the test coil (e.g. an inductive load).	Keysight 6813B Alternate: Fluke 5520A/5522A
Adapter	BNC (f) to dual stacking banana plug	Pomona 1269
Test Coil	5, 50, or 77 turns. (See coil construction instructions in this section.)	16-AWG 155C CU round magnetic wire (NEMA MW 35-C); Red enamel (transformer wire)

Test Coils

Depending on your current probe, construct a coil using transformer wire with the following number of turns. The coil should be about 4 inches (10 cm) in diameter.

N2780B; 77 turns

N2781B; 50 turns

N2782B; 5 turns

N2783B; 5 turns

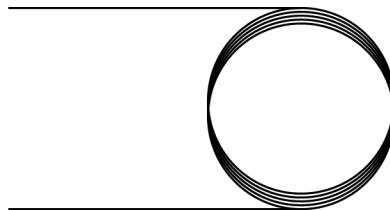

Amplitude Accuracy Test

- 1 Connect the equipment as shown in **Figure 28**. Warm up all instruments for 30 minutes before starting the test procedure. While the test system is warming up, clean the magnetic contacts on the probe jaw.

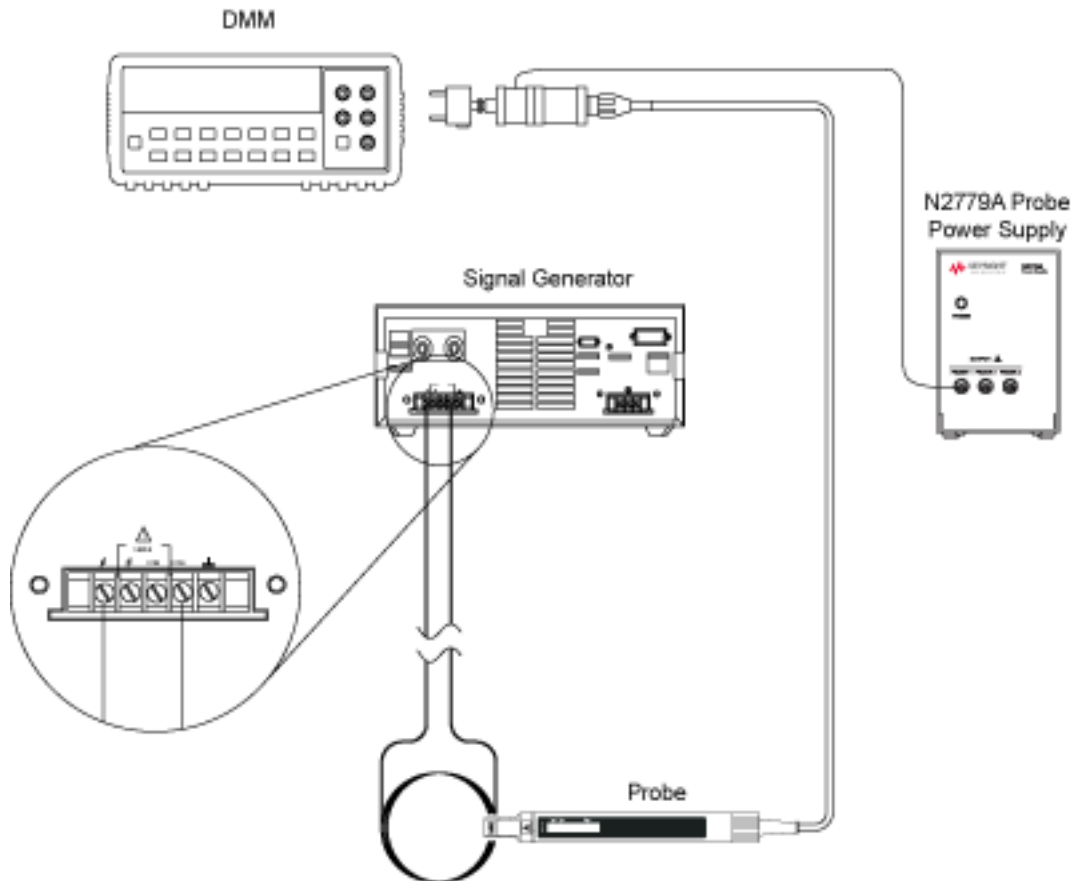

Figure 28 Test Setup Shown with N2782B

- 2 Press the **DEMAG** button on the probe terminator.
- 3 Configure the DMM to measure AC Volts.

- 4 Clamp the probe around the coil and ensure that the probe is as perpendicular as possible to the coils of wire.
- 5 Set up the signal generator to the following settings:
 - Wave shape: Sine
 - Frequency: 50 Hz
 - Amplitude:
 - N2780B: $6.5A_{rms}$
 - N2781B: $3A_{rms}$
 - N2782B: $6A_{rms}$
 - N2783B: $6A_{rms}$
 - Offset: 0.0 Vdc
- 6 Using the DMM, measure the voltage output of the probe and record this value as the **DMM Voltage** [Table 8](#).
- 7 Calculate the current by multiplying the **DMM Voltage** by the value in the **Multiplier** column. Record the result in the **Calculated Amperes** column.
- 8 Compare the **Calculated Amperes** to the **Passing Range** values to determine if the probe passes the test.

Table 8 Test Results

Model Number	DMM Voltage	Multiplier	Calculated Amperes	Passing Range
N2780B		100		505.5A to 494.5A
N2781B		100		151.6A to 148.4A
N2782B		10		30.31A to 29.69A
N2783B		10		30.31A to 29.69A

Returning the Probe for Service

If the probe is found to be defective we recommend sending it to an authorized service center for all repair and calibration needs. Perform the following steps before shipping the probe back to Keysight Technologies for service.

- 1 Contact your nearest Keysight sales office for information on obtaining an RMA number and return address.
- 2 Write the following information on a tag and attach it to the malfunctioning equipment.
 - Name and address of owner
 - Product model number (for example, N2780B)
 - Product Serial Number (for example, MYXXXXXXXX)
 - Description of failure or service required

NOTE Include probing and browsing heads if you feel the probe is not meeting performance specifications or a yearly calibration is requested.

- 3 Protect the probe by wrapping in plastic or heavy paper.
- 4 Pack the probe in the original carrying case or if not available use bubble wrap or packing peanuts.
- 5 Place securely in sealed shipping container and mark container as "FRAGILE".

NOTE If any correspondence is required, refer to the product by serial number and model number.

Contacting Keysight Technologies

For technical assistance, contact your local Keysight Call Center.

- In the Americas, call 1 (800) 829-4444
- In other regions, visit <http://www.keysight.com/find/assist>

Before returning an instrument for service, you must first call the Call Center at 1 (800) 829-4444.

Index

A

amplitude accuracy, 44

B

bandwidth, 29
 barrier, 5, 8
 BNC output connector, 6, 9

C

clamp, 6
 cleaning, 4
 coarse adjustment trimmer, 8
 current direction indication, 6, 9, 13

D

DEMAG
 switch, 6, 9
 DEMAG switch, 13
 demagnetize
 caution, 12
 switch, 6, 9
 zero adjust, 10

E

external magnetic fields, 19

H

Hall effect element, 8
 high frequencies, 19

I

inspecting, 4

K

Keysight Technologies, contacting, 46

L

lock mechanism, N2780/1B, 5
 LOCK/UNLOCK indication, 6, 9
 LOCKED, 12

M

maximum current, 29
 measurements, 11

N

N2779A power supply, 3, 11
 and oscillation, 19
 N2780/1B probes, 5
 N2780B plots, 32
 N2781B plots, 35
 N2782B plots, 37
 N2783B plots, 40

O

opening lever, 18
 N2780/1B, 6
 N2782/3B, 9
 oscilloscope connection, 12

P

performance verification, 43
 power supply cable, 6, 9
 probe
 inspecting, 4
 service, 46
 probing safety, 14

R

returning for service, 46
 rise time, 29

S

safe probing, 14
 safety, 14

safety circuit, and temperature, 17
 safety precautions, 21
 safety symbols, 23
 sensor head, 5, 8
 service center, 46

T

temperature
 drift, 18
 high ambient, 17
 operating and storage, 31

U

un-clamped conductor, avoid, 17

Z

ZERO ADJ (N27802/3B), 10
 zero adjustment, 11, 13
 zero adjustment dial, 7, 10

Printed in Malaysia

Part Number N2780-97008



* N 2 7 8 0 - 9 7 0 0 8 *