

Keysight N2800A Series Differential InfiniiMax III Probes



Notices

© Keysight Technologies, 2016, 2017, 2019, 2020, 2021

No part of this manual may be reproduced in any form or by any means (including electronic storage and retrieval or translation into a foreign language) without prior agreement and written consent from Keysight Technologies, Inc. as governed by United States and international copyright laws.

Manual Part Number

N2800-97022

Edition

June 2021

Published in USA

Published by:

Keysight Technologies, Inc.

1900 Garden of the Gods Road

Colorado Springs, CO 80907 USA

Warranty

The material contained in this document is provided “as is,” and is subject to being changed, without notice, in future editions. Further, to the maximum extent permitted by applicable law, Keysight disclaims all warranties, either express or implied, with regard to this manual and any information contained herein, including but not limited to the implied warranties of merchantability and fitness for a particular purpose. Keysight shall not be liable for errors or for incidental or consequential damages in connection with the furnishing, use, or performance of this document or of any information contained herein. Should Keysight and the user have a separate written agreement with warranty terms covering the material in this document that conflict with these terms, the warranty terms in the separate agreement shall control.

Technology Licenses

The hardware and/or software described in this document are furnished under a license and may be used or copied only in accordance with the terms of such license.

U.S. Government Rights

The Software is "commercial computer software," as defined by Federal Acquisition Regulation ("FAR") 2.101. Pursuant to FAR 12.212 and 27.405-3 and Department of Defense FAR Supplement ("DFARS") 227.7202, the U.S. government acquires commercial computer software under the same terms by which the software is customarily provided to the public. Accordingly, Keysight provides the Software to U.S. government customers under its standard commercial license, which is embodied in its End User License Agreement (EULA), a copy of which can be found at <http://www.keysight.com/find/sweula>. The license set forth in the EULA represents the exclusive authority by which the U.S. government may use, modify, distribute, or disclose the Software. The EULA and the license set forth therein, does not require or permit, among other things, that Keysight: (1) Furnish technical information related to commercial computer software or commercial computer software documentation that is not customarily provided to the public; or (2) Relinquish to, or otherwise provide, the government rights in excess of these rights customarily provided to the public to use, modify, reproduce, release, perform, display, or disclose commercial computer software or commercial computer software documentation. No additional government requirements beyond those set forth in the EULA shall apply, except to the extent that those terms, rights, or licenses are explicitly required from all providers of commercial computer software pursuant to the FAR and the DFARS and are set forth specifically in writing elsewhere in the EULA. Keysight shall be under no obligation to update, revise or otherwise modify the Software. With respect to any technical data as defined by FAR 2.101, pursuant to FAR 12.211 and 27.404.2 and DFARS 227.7102, the U.S. government acquires no greater than Limited Rights as defined in FAR 27.401 or DFAR 227.7103-5 (c), as applicable in any technical data. 52.227-14 (June 1987) or DFAR 252.227-7015 (b)(2) (November 1995), as applicable in any technical data.

Safety Notices

CAUTION

A **CAUTION** notice denotes a hazard. It calls attention to an operating procedure, practice, or the like that, if not correctly performed or adhered to, could result in damage to the product or loss of important data. Do not proceed beyond a **CAUTION** notice until the indicated conditions are fully understood and met.

WARNING

A **WARNING** notice denotes a hazard. It calls attention to an operating procedure, practice, or the like that, if not correctly performed or adhered to, could result in personal injury or death. Do not proceed beyond a **WARNING** notice until the indicated conditions are fully understood and met.

Contents

1 Using InfiniiMax III Series Probes

- InfiniiMax III Probe Amplifiers **6**
- Compatible Oscilloscopes **9**
- InfiniiMax III and III+ Probing System Family Diagram **10**
- N5477A Sampling Scope Adapter **12**
- N2852A AutoProbe II to AutoProbe III Interface Adapter **13**
- Proper Handling Techniques **14**
- Safety Information **19**
- Cleaning the probe **21**

2 InfiniiMax III Probe Heads

- N5445A InfiniiMax III Differential Browser Probe Head **24**
- N2848A InfiniiMax III+ QuickTip InfiniiMode Probe Head **29**
- N5439A InfiniiMax III ZIF Probe Head **33**
- MX0109A and N2836A InfiniiMax III Solder-in Probe Heads **39**
- N5441A InfiniiMax III Solder-in Probe Head (Discontinued) **45**
- N5444A InfiniiMax III 2.92 mm / 3.5 mm / SMA Probe Head **48**
- N2835A InfiniiMax III Differential Connectivity Kit and Accessories **51**
- Strain Relieving the Probe Heads **53**

3 Maintaining Probe Heads

- Replacing Axial Resistor Tips **56**
- Replacing N5441A Probe Head Wires **59**

4 Performance Specifications / Characteristics

- InfiniiMax III Warranted Specifications **64**
- N2800A/1A/2A/3A Probe Amplifiers Characteristics **65**
- InfiniiMax III Probe Heads Characteristics **67**
- InfiniiMax III Probe Heads Dimensions **68**
- Environmental Specifications **72**
- Safety Specifications **73**

5 Calibration / Deskew Procedure

- Procedure **76**

6 Performance Verification

- Bandwidth Performance Verification **84**
- DC Input Resistance Performance Verification **102**
- Performance Test Record **105**

7 Performance Plots

MX0109A and N2836A 26 GHz Solder-In Probe Heads (with N2803A)	109
N2838A/N5439A 25 GHz PCB ZIF Tip/Head (with N2803A)	112
N5440A/N5439A 28 GHz Ceramic ZIF Tip/Head (with N2803A)	115
N5447A/N5439A 28 GHz Ceramic High-Sensitivity ZIF Tip/Head (with N2803A)	118
N5441A 16 GHz Solder-In Head (with N2803A)	121
N5444A 30 GHz SMA 2.92 mm Head (with N2803A)	124
N5445A 30 GHz Browser Head, 1 mm span (with N2803A)	127
N5445A 30 GHz Browser Head, 2 mm span (with N2803A)	130
N5445A 30 GHz Browser Head, 3 mm span (with N2803A)	133

8 SPICE Models

SPICE Models for N5440/1/4/5/7A Probe Heads	136
SPICE Models for N2838A, MX0109A, and N2836A Probe Heads	142
Simplified InfiniiMax III Schematic	145

1 Using InfiniiMax III Series Probes

InfiniiMax III Probe Amplifiers	6
Compatible Oscilloscopes	9
InfiniiMax III and III+ Probing System Family Diagram	10
N5477A Sampling Scope Adapter	12
N2852A AutoProbe II to AutoProbe III Interface Adapter	13
Proper Handling Techniques	14
Safety Information	19
Cleaning the probe	21

This chapter contains documentation on using the InfiniiMax III probing system.

The InfiniiMax III probing system offers you the highest performance available for measuring differential and single-ended signals, with flexible connectivity solutions for today's high-density ICs and circuit boards. Four different InfiniiMax III probe amplifiers ranging from 16 GHz to 30 GHz are available for matching your probing solution to your performance and budget requirements. A proprietary 200 GHz fT InP (indium phosphide) IC process with backside ground vias and novel thick film technology is utilized to accommodate your highest performance needs.

The family diagram for the InfiniiMax III probing system is shown in "[InfiniiMax III and III+ Probing System Family Diagram](#)" on page 10. This system is designed to give you the maximum flexibility in matching your probe to your setup. The following pages will discuss each of the adapters, probe amplifiers, and probe heads in detail.

CAUTION

Refer to "[Proper Handling Techniques](#)" on page 14 before connecting any probe to the oscilloscope.

InfiniiMax III Probe Amplifiers

There are four InfiniiMax III amplifier models:

- N2800A 16 GHz Probe Amplifier
- N2801A 20 GHz Probe Amplifier
- N2802A 25 GHz Probe Amplifier
- N2803A 30 GHz Probe Amplifier

Each probe amplifier is pre-loaded with its specific measured S-parameters. When used with the Infiniium 90000 X-series, the oscilloscope downloads these parameters and automatically corrects the response of the unique probe system.

WARNING

Before using the probe, refer to **“Proper Handling Techniques”** on page 14 and **“Safety Information”** on page 19.

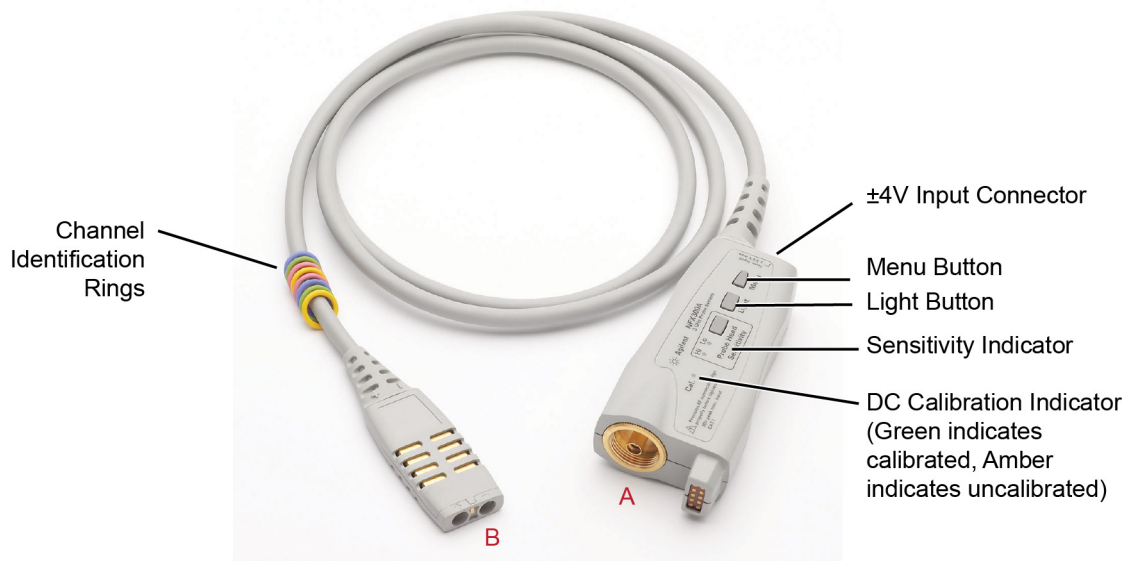

Figure 1 InfiniiMax III Probe Amplifier

±4V Input Connector

Use this connector to connect the N5444-61601 Termination Voltage cable supplied with the N5444A SMA probe head. See **“N5444A InfiniiMax III 2.92 mm / 3.5 mm / SMA Probe Head”** on page 48 for information on this cable and its usage.

Menu Button

Press this button to bring up the Probe dialog box in the oscilloscope GUI.

Light Button

Press this button to turn the LED headlights on the browser probe head on/off. Pressing and holding this button will ramp the intensity of the LED headlights. You may want to adjust the brightness to accommodate different lighting or glare conditions.

Sensitivity Indicator

If you are using the ZIF probe head, the sensitivity indicator tells you which ZIF tip is connected to the probe head. If the N5447A ceramic high sensitivity ZIF tip is connected then the “Hi” sensitivity LED will be illuminated. If the N5440A ceramic ZIF tip is connected then the “Normal” sensitivity LED will be illuminated. This will assist you in ensuring that the correct ZIF tip is selected in the oscilloscope GUI’s probe dialog box.

CAUTION

If you select the wrong pairing of ZIF probe head and ZIF probe tip in the oscilloscope GUI’s probe menu, your waveforms will look incorrect.

DC Calibration Indicator

Indicates if the particular combination of probe amplifier, probe head, and oscilloscope channel input is calibrated. Any time you use a new probe head type, a new probe amplifier, or a different channel on the oscilloscope, the **DC Cal** indicator turns amber, indicating that a DC calibration is required. After performing a calibration as described in [Chapter 5](#), “Calibration / Deskew Procedure”, the **DC Cal** indicator turns green.

Channel Identification Rings

Use the channel-identification rings to match each probe to the color of the oscilloscope’s input channel to which it is connected. This enables you to quickly know which probe is connected to each channel without having to trace cables back to the oscilloscope inputs.

Channel Connection

CAUTION

Refer to **“Proper Handling Techniques”** on page 14 before connecting any probe to the oscilloscope.

The connector labeled A in [Figure 1](#) on page 6 plugs into one of the oscilloscope channel inputs. If connecting it directly to an Infiniium 90000 X-series oscilloscope, plug it into the channel and then turn the gray clutch/dial around the input ([Figure 2](#) on page 8) until it clicks. To disconnect the probe amplifier, loosen the clutch on the oscilloscope input and disconnect the probe amplifier. If you are using an InfiniiMax III probe amplifier with Keysight’s 86100D sampling oscilloscope, you will need to use the N5477A sampling scope adapter.

The connector labeled B in [Figure 1](#) on page 6 connects to one of the InfiniiMax III probe heads.

CAUTION

InfiniiMax I and II probe heads are not compatible with the InfiniiMax III probe amplifiers and vice versa.

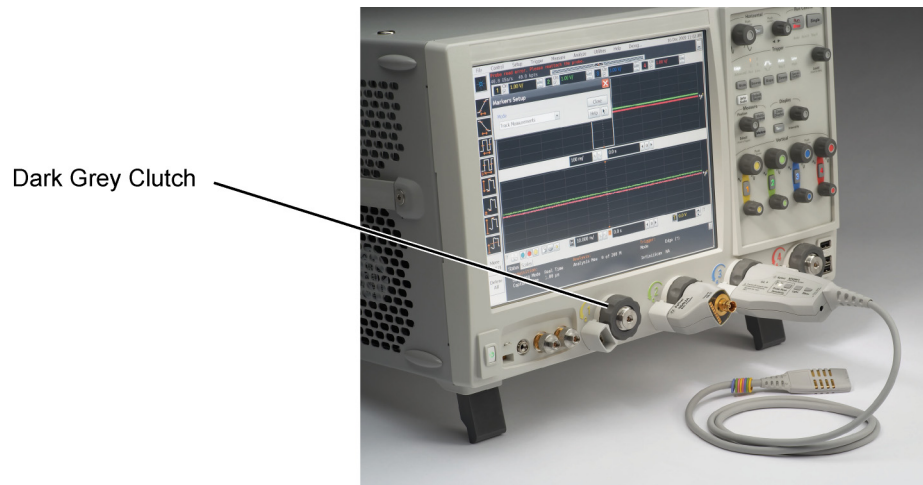

Figure 2 Clutches on an InfiniiMax 90000 X-series oscilloscope

NOTE

The clutches on the InfiniiMax 90000 X-series do not require a mechanical calibration. They will maintain the same tolerance as the Keysight torque wrench (8 in lbs \pm 1 in lbs).

Probe Amplifier Bandwidth Upgrades

The InfiniiMax III probe amplifiers are upgradeable. When you order a probe bandwidth upgrade, you receive a new probe with a new model number and new serial number. The bandwidth upgrades are:

- N5446A-001 16 GHz to 20 GHz bandwidth upgrade
- N5446A-002 20 GHz to 25 GHz bandwidth upgrade
- N5446A-003 25 GHz to 30 GHz bandwidth upgrade
- N5446A-004 16 GHz to 25 GHz bandwidth upgrade
- N5446A-005 16 GHz to 30 GHz bandwidth upgrade
- N5446A-006 20 GHz to 30 GHz bandwidth upgrade

Compatible Oscilloscopes

The N2800A-series probe's AutoProbe II interface connects directly to series 90000 Q, V, X, Z-series, and UXR-series (13 - 33 GHz) Infiniium oscilloscopes.

- Use an N5477A adapter to connect to the 86100D oscilloscope.
- Use an N2852A AutoProbe II to AutoProbe III interface adapter to connect to the UXR-series (40 - 110 GHz) Infiniium oscilloscope.

Table 1 N2800A-Series Probes and Compatible Oscilloscopes

Oscilloscope	Adapter Required	Minimum Required Firmware Version
90000 Q, V, X, Z-Series	none	5.50
86100C/D Series	N5477A	–
UXR-Series (13-33 GHz)	none	10.0
UXR-Series (40 GHz or higher)	N2852A	10.10

Is your oscilloscope software up-to-date?

Keysight periodically releases software updates to support your probe, fix known defects, and incorporate product enhancements. To download the latest firmware, go to www.Keysight.com and search for your oscilloscope's model number. Click on the "Drivers, Firmware & Software" tab under the Technical Support link.

InfiniiMax III and III+ Probing System Family Diagram

The following diagram shows the InfiniiMax III and InfiniiMax III+ probes and probe heads. The diagram is not drawn to scale.

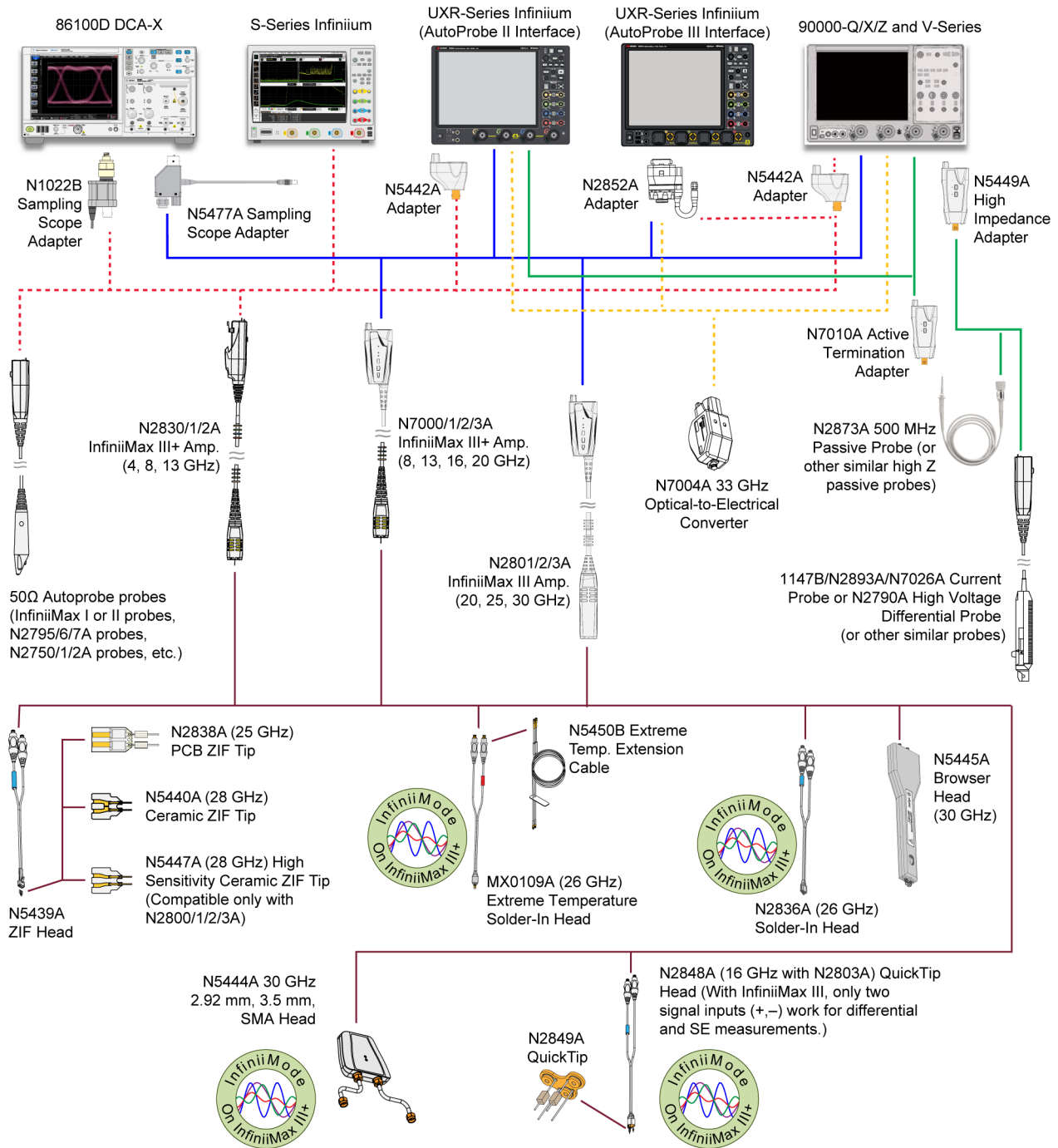

Figure 3 InfiniiMax III / III+ Probing System

For extreme temperature testing, use the N5450B InfiniiMax extreme temperature extension cable with the MX0109A or N5441A solder-in head.

The MX0109A or N5441A probe heads can withstand temperatures from -55°C to $+150^{\circ}\text{C}$ for up to 750 and 250 test cycles respectively.

CAUTION

None of the N2800/1/2/3A probe amplifiers can withstand the extreme temperatures (-55°C to $+150^{\circ}\text{C}$) that the N5450B can withstand. When using the N5450B extension cable, do not subject the InfiniiMax III probe amplifier to extreme temperatures.

CAUTION

None of the other probe heads are designed for extreme temperature testing.

The N5449A includes one N2873A probe. The adapter is specifically tuned for the N2873A probe. Similar probes (1 $\text{M}\Omega$ input) can be used. Other probes may not meet the bandwidth specification.

NOTE

N2849A QuickTips are also compatible with N2851A QuickTip Probe Heads, which are designed for 1130/1/2/4A InfiniiMax I and 1168/9A InfiniiMax II probes.

Use the N5443A Performance Verification (PV) accessory fixture to properly position the probe for PV testing.

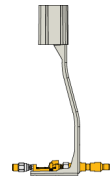

N5477A Sampling Scope Adapter

The N5477A Sampling Scope Adapter allows you to connect the InfiniiMax III probing system to the Infiniium 86100D DCA-X sampling oscilloscope or other RF instruments.

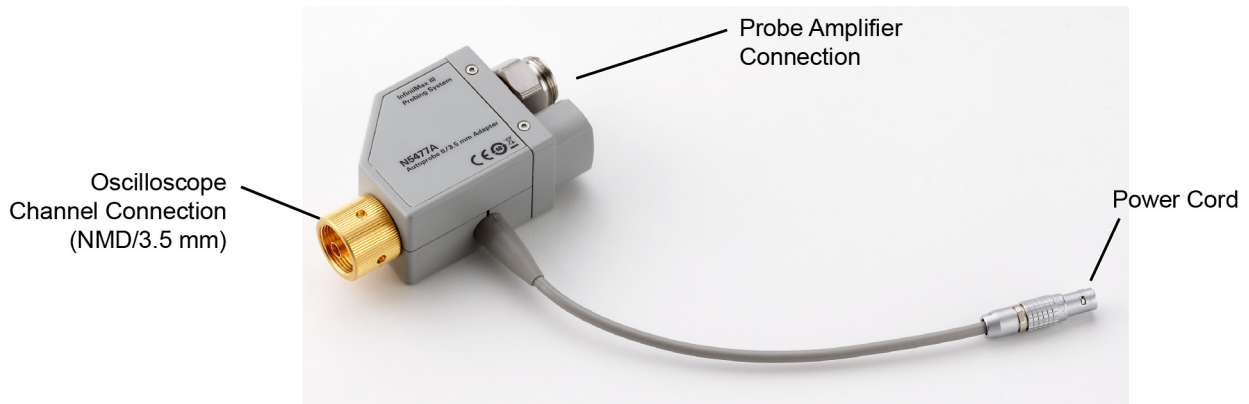

Figure 4 N5477A InfiniiMax III Sampling Scope Adapter

Connect the NMD/3.5 mm side of the adapter to one of the channel inputs on the sampling oscilloscope. Then connect the power cord to either the probe power output on the DCA-X 86100D wideband oscilloscope (if the module being used has this receptacle) or to the 1143A power module. Finally, connect the other side of the adapter to the InfiniiMax III probe amplifier.

Previously, the DCA-X wideband oscilloscope was limited to 13 GHz of probing, but with the N5477A sampling oscilloscope adapter, the DCA-X can now probe up to 30 GHz.

The N5477A sampling oscilloscope adapter can also be used to connect the InfiniiMax III probing system to generic 50 Ohm test equipment as long as the 1143A power supply and 5062-1247 NMD male-to-3.5mm female adapter are used. Both of these parts can be ordered through Keysight Technologies.

N2852A AutoProbe II to AutoProbe III Interface Adapter

This adapter allows you to connect the N2800A / N2801A / N2802A / N2803A InfiniiMax III probe to a Keysight UXR-Series (40GHz or higher) Infiniium oscilloscope that has the AutoProbe III interface.

To know more about this adapter, visit <http://www.keysight.com/find/N2852A> and then download the adapter's user guide available in the *Document Library* tab.

CAUTION

Care should be taken while handling the N2852A adapter's RF cable. Avoid bending this cable backwards or kinking the cable in order to ensure measurements accuracy.

Proper Handling Techniques

This section will assist you in properly handling your InfiniiMax III N2800A-series probes to prevent damage and maintain high performance. For more safe-handling information, go to www.keysight.com/find/scope-demo, click on **See Keysight's probes in action**, and then InfiniiMax III ESD Best Practices demo video listed under the Document Library tab.

CAUTION

Electrostatic discharge (ESD) can quickly and imperceptibly damage or destroy high-performance probes, resulting in costly repairs. Always wear a wrist strap when handling probe components.

CAUTION

Probes are sensitive devices and should be treated with care. Do not bend or kink the probe amplifier cable. Do not drop heavy objects on the probe, drop the probe from large heights, spill liquids on the probe, etc. Any of these examples can significantly degrade the performance of the probe.

CAUTION

When storing the probe, it is best to coil the cable in a large radius and avoid a net twist in the cable during the process. This can be done in a similar manner to how garden hoses or extension cords are typically coiled.

CAUTION

InfiniiMax I and II probe heads cannot be used with InfiniiMax III probe amplifiers and InfiniiMax III probe heads cannot be used with InfiniiMax I and II amplifiers.

CAUTION

Never allow the probe head to be connected to the probe amplifier, if the probe amplifier is *not* connected to the oscilloscope channel.

CAUTION

Always disconnect an N5441A solder-in probe head from the probe amplifier before unsoldering, moving to a new position, and re-soldering the head.

Before Connecting a Probe

InfiniiMax probes and accessories are ESD sensitive devices and should be treated with care. Before using or handling the probe or accessories, always wear a grounded ESD wrist strap and ensure that cables and probe heads are discharged before being connected.

All work, including connecting probe amplifiers to the oscilloscope, should be performed at a static-safe work station as shown in **Figure 5** on page 15.

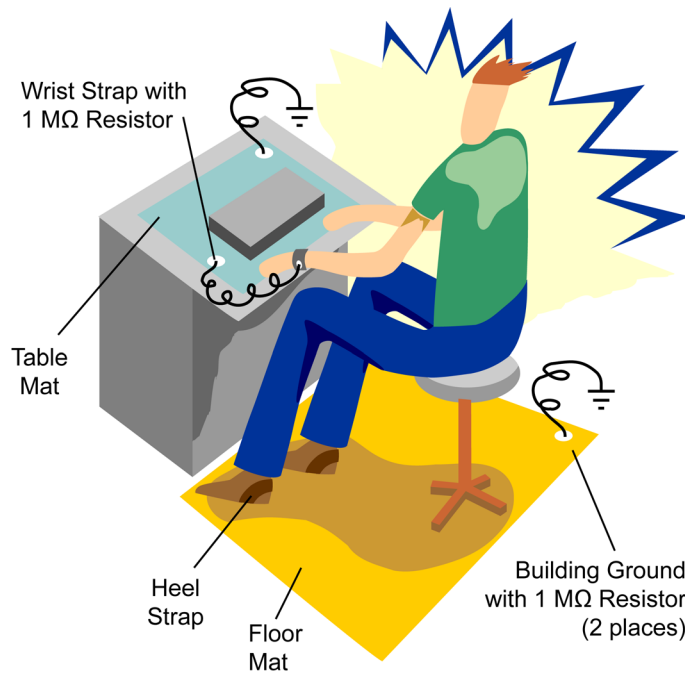

Figure 5 Static-Safe Work Station

Many scopes including Keysight's 90000X series have a front-panel ground socket. You can plug the wrist strap into the ground socket as seen in the following picture.

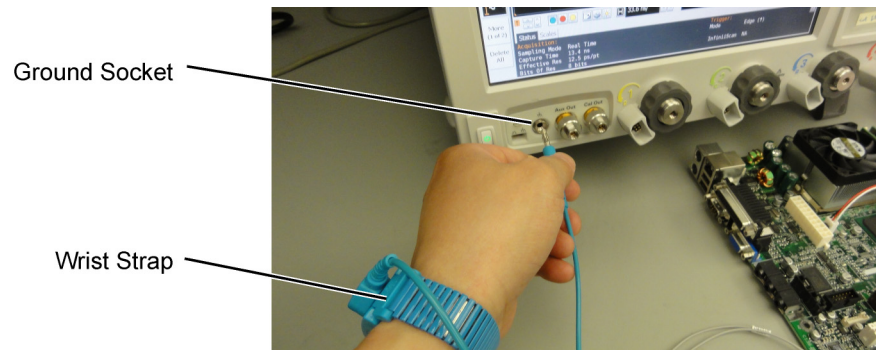

Figure 6 Wrist Strap Connected to Oscilloscope Ground Socket

The static-safe work station shown in **Figure 5** uses two types of ESD protection:

- Conductive table-mat and wrist-strap combination.
- Conductive floor-mat and heel-strap combination.

Both types, when used together, provide a significant level of ESD protection. Of the two, only the table-mat and wrist-strap combination provides adequate ESD protection when used alone. To ensure user safety, the static-safe accessories must provide at least 1 MΩ of isolation from ground. Purchase acceptable ESD accessories from your local supplier.

WARNING

These techniques for a static-safe work station should not be used when working on circuitry with a voltage potential greater than 500 volts.

Connecting a Probe to an Oscilloscope Channel

To protect against ESD damage, always use the following steps when connecting your probe to the oscilloscope.

- 1 If the Device Under Test (DUT) is *not* grounded to the oscilloscope via the AC mains ground, connect the DUT ground to the oscilloscope ground. An example of a device having a floating ground would be a battery-powered DUT.
- 2 Attach the probe head to the DUT.

CAUTION

At this point, the N2800A-series probe amplifier must *not* be connected to the oscilloscope or the probe head.

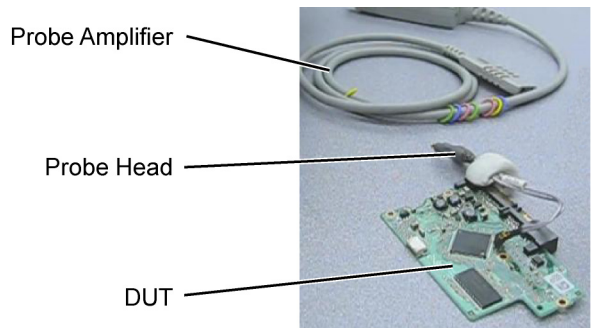

Figure 7 Probe Head Attached to DUT

- 3 Connect the probe amplifier to the oscilloscope while hand tightening the dark gray clutch ring. The clutch ring limits the applied torque to 8 in-lb (± 1 in-lb).

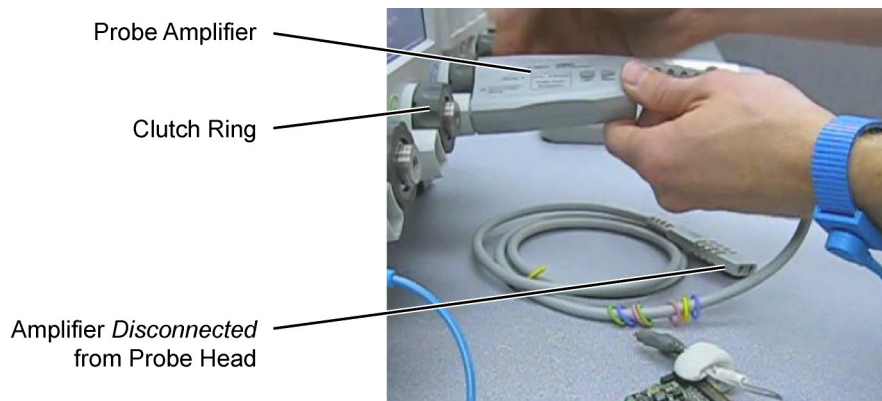

Figure 8 Probe Amplifier Connected to Oscilloscope

- 4 Connect the probe head to the probe amplifier.

CAUTION

When connecting a probe head to a probe amplifier, push straight in. When disconnecting a probe head from an amplifier, pull the probe head connectors straight out of the sockets. Never bend the probe head in order to pry it loose from the amplifier. Also, do not wiggle the probe head up and down or twist it to remove the connectors from the sockets. This can damage the pins in the amplifier or the probe head itself.

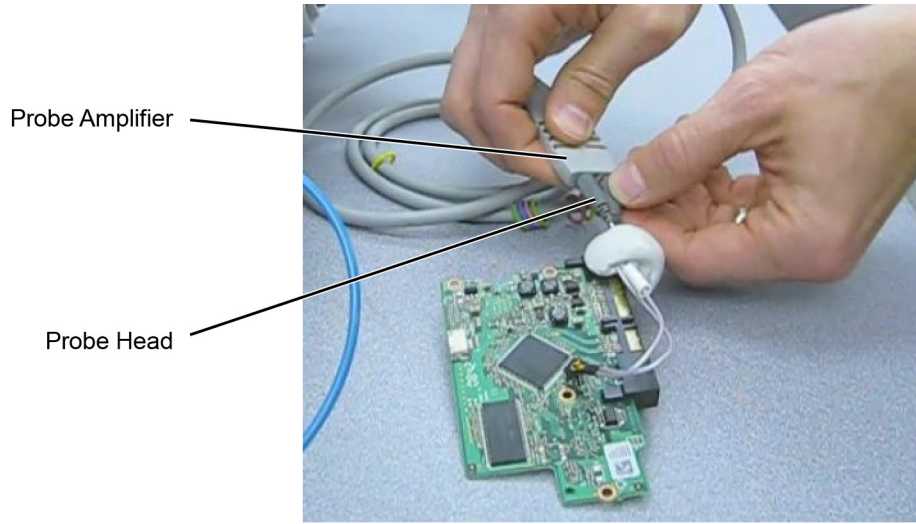

Figure 9 Probe Head Connected to Probe Amplifier

Disconnecting a Probe from an Oscilloscope Channel

Always disconnect the probe head from the probe amplifier before:

- disconnecting the probe amplifier from the oscilloscope.
- switching the probe amplifier from one oscilloscope channel to another.

CAUTION

Never allow the probe head to be connected to the probe amplifier, if the probe amplifier is *not* connected to the oscilloscope channel.

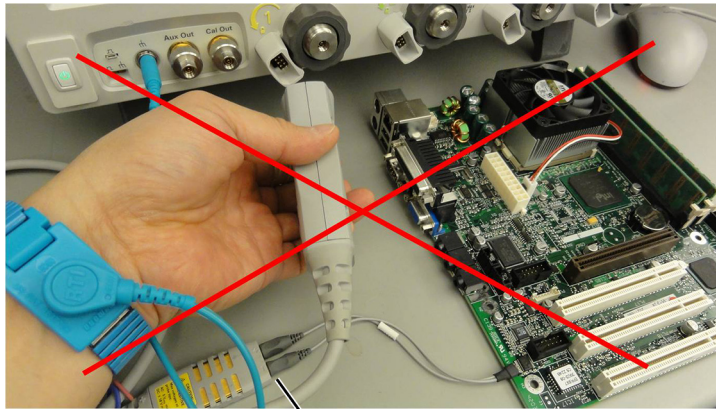

Always disconnect Probe Head
from Probe Amplifier First!

Figure 10 Probe Improperly Disconnected from Oscilloscope while Probe Head is Connected to the Probe Amplifier

Probing the DUT

When making your measurements, you'll often need to probe different locations on the DUT. You can safely move any of the following three probe heads without having to first break the amplifier-to-head connection:

- N5445A differential browser head
- N5439A ZIF head
- N5444A 2.92 mm/3.5 mm/SMA head

The only exception is when the DUT is not grounded to the oscilloscope via the AC mains ground. In this case, connect the DUT ground to the oscilloscope ground before moving the probe. An example of a device having a floating ground would be a battery-powered DUT.

When probing with an N5441A solder-in probe head, always disconnect the probe head from the amplifier before moving the head to a new probing point. This is because some soldering-iron tips can hold a charge which can damage the probe amplifier.

CAUTION

Always disconnect an N5441A solder-in probe head from the probe amplifier before un-soldering, moving to a new position, and re-soldering the head.

Safety Information

This product has been designed and tested in accordance with accepted industry standards, and has been supplied in a safe condition. The documentation contains information and warnings that must be followed by the user to ensure safe operation and to maintain the product in a safe condition.

To avoid personal injury and to prevent fire or damage to this product or products connected to it, review and comply with the following safety precautions. Be aware that if you use this probe assembly in a manner not specified, the protection this product provides may be impaired.

In addition to the safety notices in this section, also refer to the CAUTION and WARNING notices listed in other sections of this guide.

WARNING

Observe Probe Ratings. Do not apply any electrical potential to the probe input which exceeds the maximum rating of the probe. These probe assemblies are NOT intended for measurements on circuits rated for CAT II, CAT III, or CAT IV.

WARNING

Indoor Use Only. Do not operate in wet/damp environments. Keep product surfaces dry and clean.

WARNING

Never leave the probe connected to a conductor while it is not connected to an oscilloscope or voltage measuring instrument.

WARNING

Periodically inspect the probe and probe wires to check for any damage. Do Not Operate With Visible or Suspected Failures. If you suspect there is damage, have it inspected by a Keysight authorized service personnel.

WARNING

Do not install substitute parts or perform any unauthorized modification to the probe.

WARNING

Do not operate the probe or oscilloscope in the presence of flammable gasses or fumes. Operation of any electrical instrument in such an environment constitutes a definite safety hazard.

WARNING

If the probe is used in a manner not specified by the manufacturer, the protection provided by the probe assembly may be impaired.

WARNING

Do not attempt internal service or adjustment. Service should be carried out by a Keysight Technologies authorized service personnel. For any service needs, contact Keysight Technologies.

CAUTION

The probe cable is a sensitive part of the probe and, therefore, you should be careful not to damage it through excessive bending or pulling. Avoid any mechanical shocks to this product in order to guarantee accurate performance and protection.

Cleaning the probe

If the probe requires cleaning, disconnect it from the oscilloscope and clean it with a soft cloth dampened with a mild soap and water solution. Make sure the probe is completely dry before reconnecting it to the oscilloscope.

2 InfiniiMax III Probe Heads

N5445A InfiniiMax III Differential Browser Probe Head	24
N2848A InfiniiMax III+ QuickTip InfiniiMode Probe Head	29
N5439A InfiniiMax III ZIF Probe Head	33
MX0109A and N2836A InfiniiMax III Solder-in Probe Heads	39
N5441A InfiniiMax III Solder-in Probe Head (Discontinued)	45
N5444A InfiniiMax III 2.92 mm / 3.5 mm / SMA Probe Head	48
N2835A InfiniiMax III Differential Connectivity Kit and Accessories	51
Strain Relieving the Probe Heads	53

This chapter documents the InfiniiMax III probe heads.

CAUTION

Refer to **“Proper Handling Techniques”** on page 14 before connecting any probe head to a probe amplifier.

N5445A InfiniiMax III Differential Browser Probe Head

The N5445A browser head (30 GHz) is the best choice for the general-purpose trouble shooting of differential signals with spring-loaded tips and variable spacing from 20 mil to 125 mil (or 0.5 mm to 3.1 mm).

The span between the signal tips is easily adjusted with a thumb wheel on the browser (see [Figure 11](#)).



NOTE

For performance plots, refer to [Chapter 7](#), “Performance Plots.”

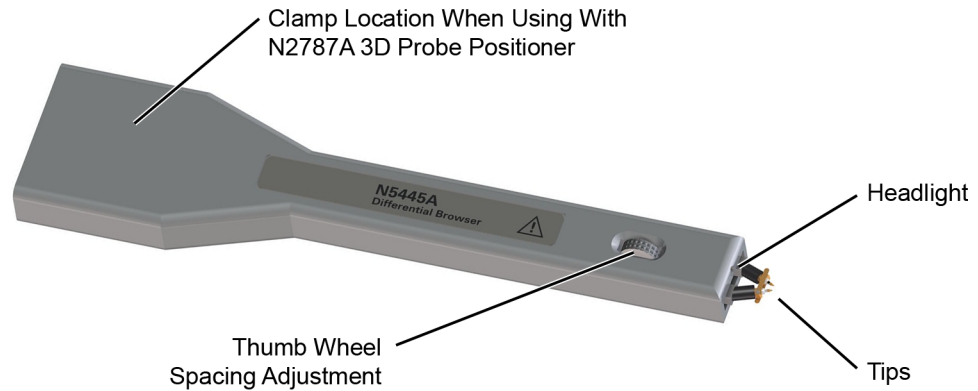

Figure 11 N5445A InfiniiMax III Differential Browser Head

Using the LED Headlights

A pair of LED headlights are integrated into the tip of the browser to illuminate the probing area for better visibility. The headlights are controlled via the Light button on the InfiniiMax III probe amplifier (see [Figure 1](#) on page 6). Pressing this button turns the headlights on / off while pressing the button and holding it down ramps the intensity of the headlights.

Adjusting the Tip Span

Turn the browser’s thumb wheel (see [Figure 12](#)) to adjust the tip spacing from 20 to 125 mil (0.5 mm to 3.1 mm). Do not force the adjustment near the end of its range.

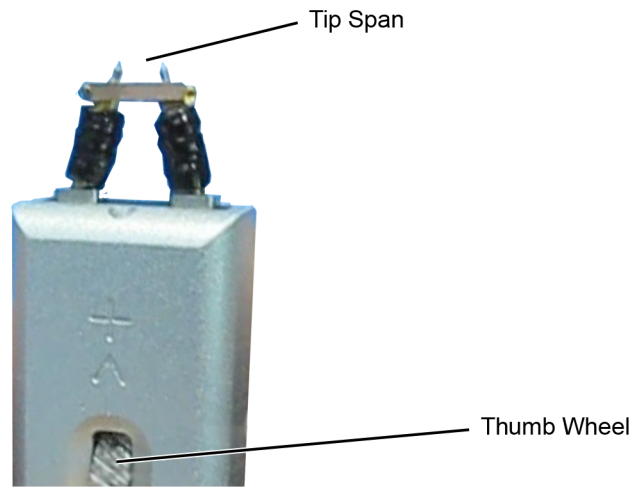

Figure 12 Adjusting the Tip Span

Tip-Span Entry for Probe Calibration

When calibrating the probe, you will be prompted to enter the span setting on the oscilloscope’s Probe Calibration dialog box. To determine the tip span, do the following steps:

- 1 Adjust the browser’s tip span for your measurement.
- 2 Locate the tip-span gauge on the browser’s protective cap as shown in **Figure 13**.
- 3 Determine which of the three possible tip-span settings most closely matches the browser’s tip span.

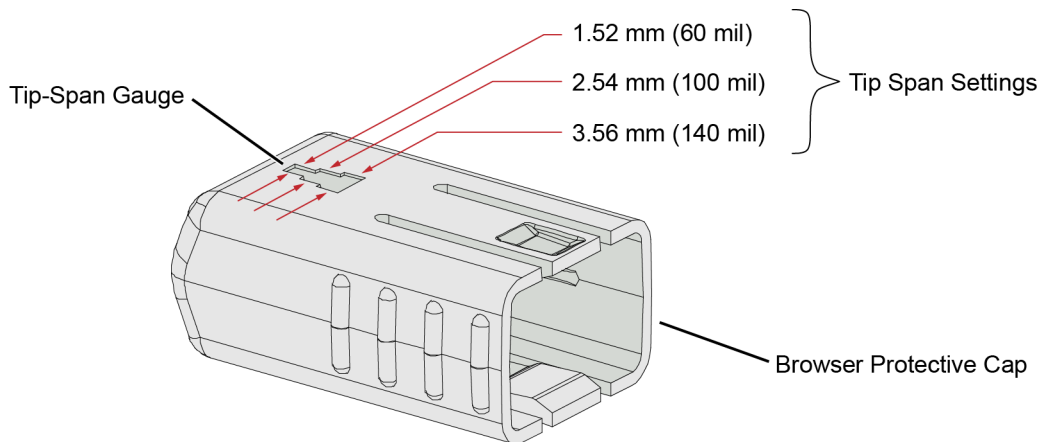

Figure 13 Tip Span Gauge on Browser Protective Cap

Mounting the Browser

There are two holes on the back side of the browser. Use these holes to mount the browser to a customer designed holder. **Figure 14** below shows the dimensions of these mounting holes.

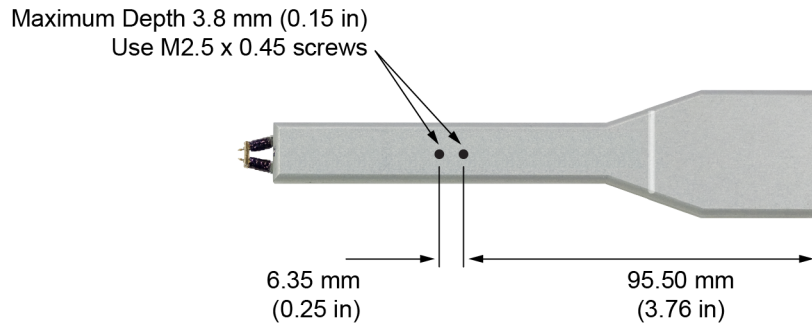

Figure 14 Dimensions of Mounting Holes

Probe Along the Browser's Axis

To prevent tip damage, probe along the browser's axis as shown in **Figure 15**. Hold the probe vertical and perpendicular to the circuit board.

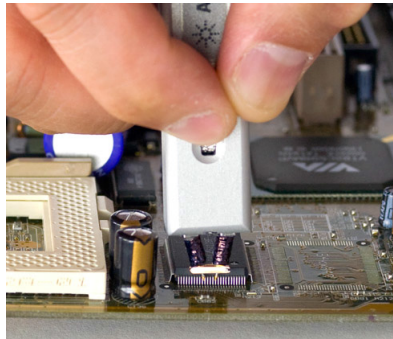

Figure 15 Proper Probe Handling

CAUTION

To avoid damaging the browser's tips, do not apply a side load to the browser.

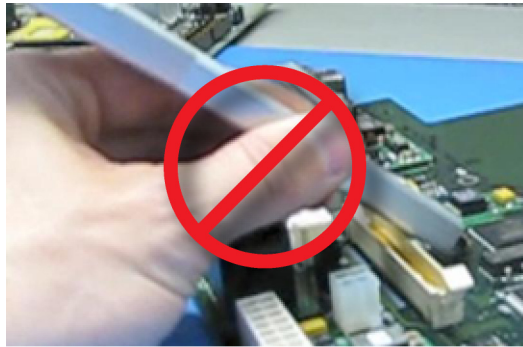

Figure 16 Improper Probe Handling

CAUTION

Do not apply too much force when browsing. The weight of the probe in your hand should be sufficient. The axial travel of the probe is about 15 mils (0.4 mm).

CAUTION

The browser's protective cap should be kept on the browser at all times except when probing.

CAUTION

Always remove the browser from the device under test (DUT) before disconnecting the probe amp from the oscilloscope.

Replaceable Parts

Figure 17 shows the replaceable parts for the N5445A.

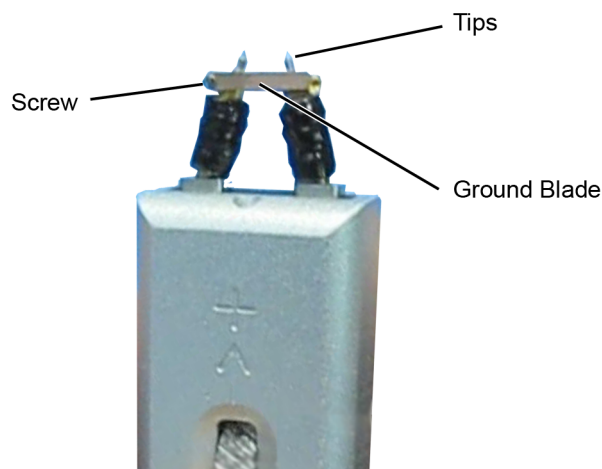

Figure 17 Browser Tips and Ground Blade

Table 2 N5445A Replaceable Parts

Description	Qty	Part Number
Browser tips	4	N5476A
Ground Blade	1	N4855A
Ground Blade Screws	1	N4856A

N2787A 3D Probe Positioner

Using the N2787A 3D probe positioner with the N5445A browser probe head reduces the chance of breaking the browser tips and ensures that the tips maintain solid contact. Use the following steps to position the probe using the N2787A:

- 1 Lock the vertical compliance of the probe positioner.
- 2 Clamp the browser into the positioner, aligning the browser's slot with the positioner's gripping pad.
- 3 While holding the browser, loosen the main knob and position the probe.
- 4 Use the browser's own weight to depress the tips, and tighten the main knob to lock the probe's position.

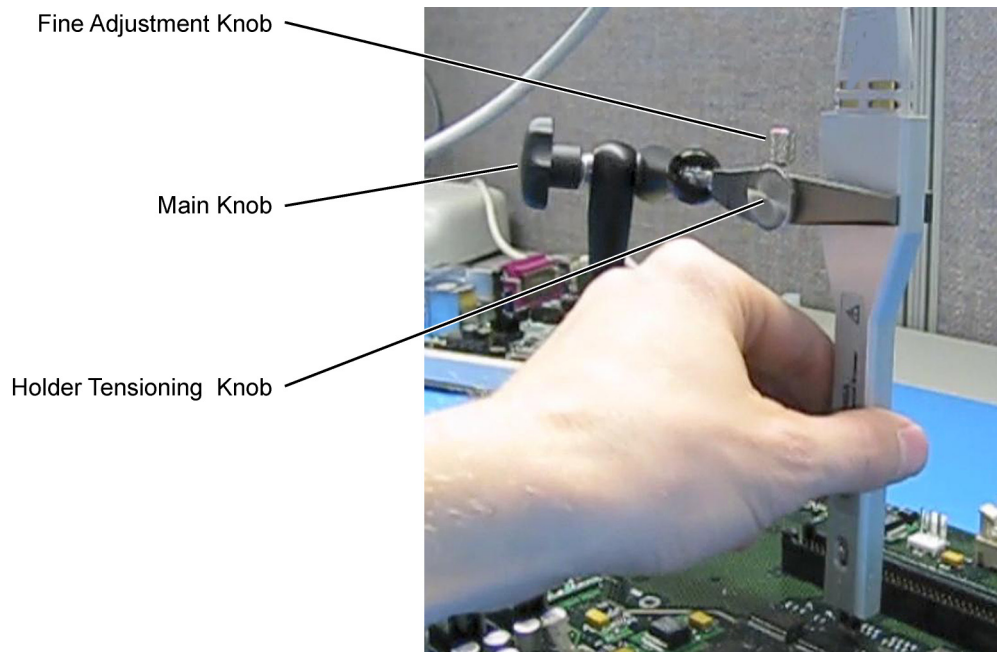
**Figure 18** Using the Browser with the N2787A 3D Probe Positioner

N2848A InfiniiMax III+ QuickTip InfiniiMode Probe Head

The N2848A QuickTip probe head is used with an N2849A QuickTip and together they provide the following advantages:



- Easy-to-make secure magnetic mechanical connection between probe head and QuickTip as shown in [Figure 19](#). No latch lever is used!
- Extreme temperature environments such as temperature chambers.

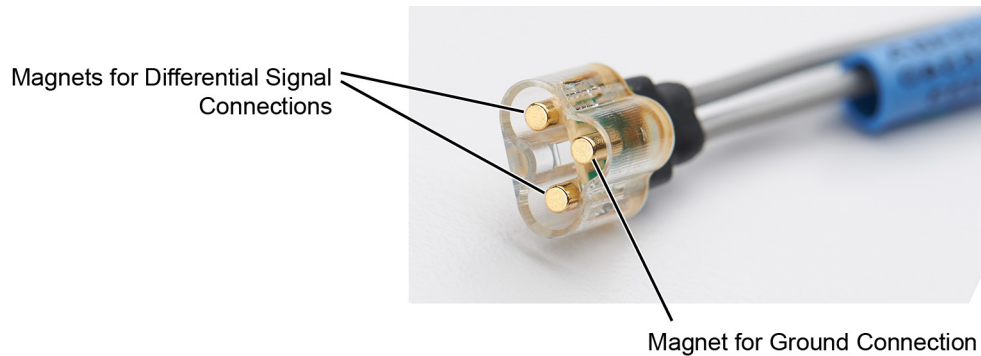

Figure 19 Magnet Connections in Probe Head

NOTE

When used with N2830A-series probe amplifiers, the N2848A is InfiniiMode compatible. InfiniiMode allows you to make differential, common mode, and single ended measurements without having to re-solder the tip leads. InfiniiMode is not available when using with N2800A-series probe amplifiers.

Table 3 N2848A with N2804A Probe Amplifier

Item	Characteristic
Bandwidth	16 GHz
Input C (Differential)	340 fF
Input C (Single Ended)	200 fF
Rise Time	27.1 ps (10 - 90%)
Fall Time	19.3 ps (20 - 80%)

Permanently solder any number of N2849A QuickTips to your DUT as shown in [Figure 20](#) on page 30. Because the probe head is magnetically connected (instead of mechanically connected) to the QuickTip, you can effortlessly connect and disconnect to each QuickTip. For best performance, position the QuickTip vertically on the DUT. The N2849A QuickTip has two signal leads and two ground leads. The ground leads have minimal effect on your differential measurements. However, if you are making only differential measurements you

can optionally cut off the ground leads or fold them out of the way. Be aware that without the ground leads, the mechanical stability of the QuickTip will be reduced and you will need to stabilize the probe head.

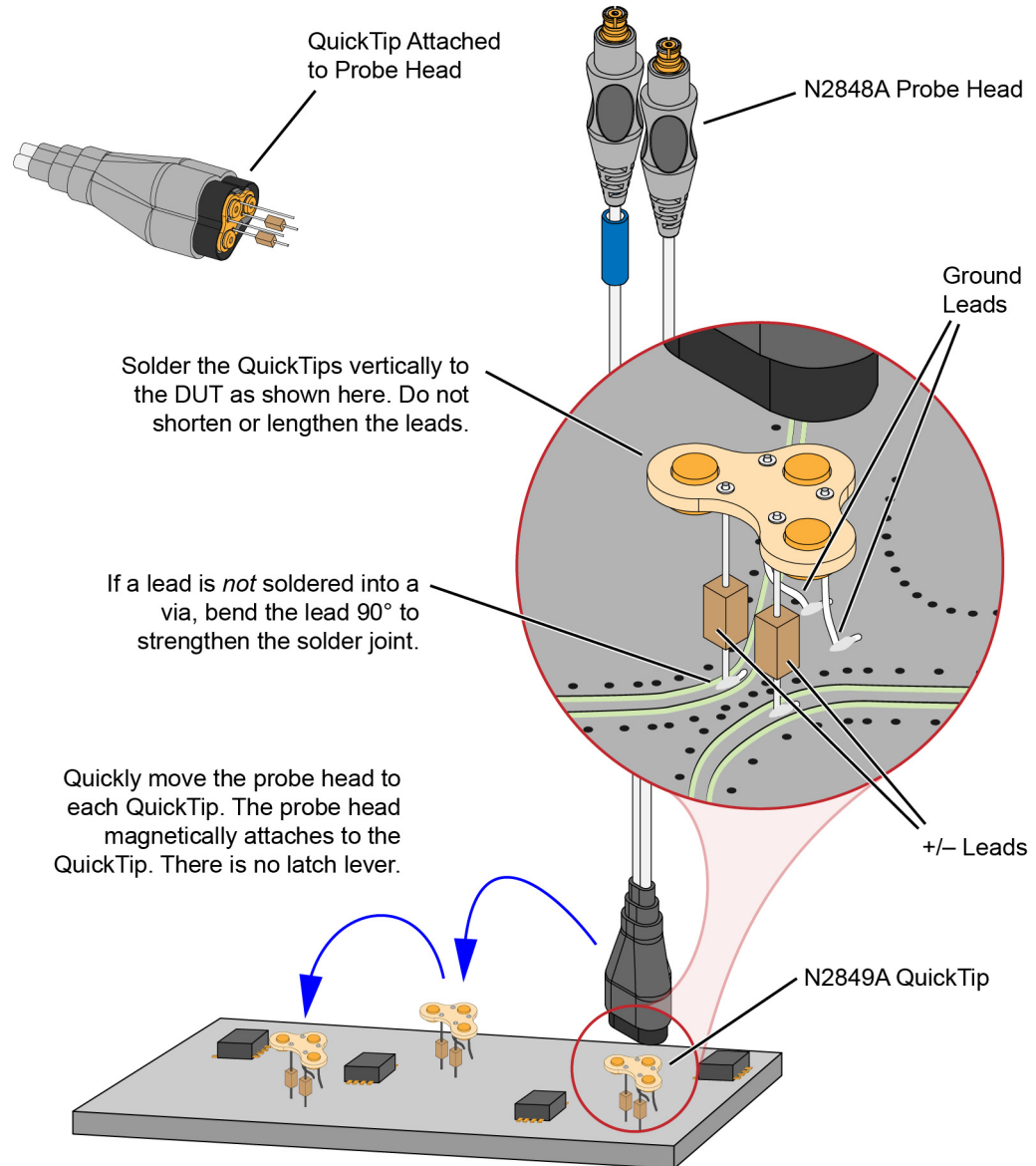

Figure 20 Probing with the N2848A Probe Head and N2849A QuickTip

CAUTION

Do not replace or repair the N2849A QuickTip's resistor or ground leads. Attempting to do so will damage the ability of the tip to mate with the N2848A probe head.

NOTE

The N2848A does not include any N2849A QuickTips. The N2849A must be ordered separately.

N2849A QuickTips are also compatible with N2851A QuickTip InfiniiMode Probe Heads, which are designed for 1130/1/2/4A InfiniiMax I and 1168/9A InfiniiMax II probes.

Connecting a QuickTip to the DUT

Use the following tips when soldering the QuickTips to your DUT:

- Orient the QuickTip vertically as shown in **Figure 20** on page 30.
- Solder the four leads to vias or surfaces.
- When soldering to a via, always trim the lead close to the via's underside.
- If a lead is to be soldered to a surface and not a via, make a stronger solder joint by bending the end of the lead 90°. For signal leads, bend the wire approximately half way between the resistor and the end of the wire. Bend the ground leads at about the same distance.

CAUTION

Always mechanically strain-relieve the QuickTip head *before* using to protect both your probe accessories and DUT from damage.

CAUTION

Be careful not to damage the tip wires when handling the QuickTips. Wires can be carefully reshaped with tweezers or fingers if necessary.

CAUTION

The QuickTips are very fragile. They must be manufactured in this way in order to meet the high-performance, high bandwidth applications they are intended for. Be extremely careful when handling.

NOTE

Resistor and wire leads on the QuickTip are factory trimmed to the proper length for use. Adding wire length to the tip of the mini-axial lead resistors or to the ground leads will degrade the performance of the probe.

NOTE

Soldering the ground wires is not required when making differential or single-ended (+ or - leads) measurements.

Cleaning the Magnetic Connections

If the three magnetic connections in the head become dirty, clean the connections using the following steps:

- 1 Use compressed air or a cloth to remove any loose dirt.
- 2 Gently rub a small piece of tack putty (supplied with the probe) against the magnetic connections to clean off any remaining surface grime.

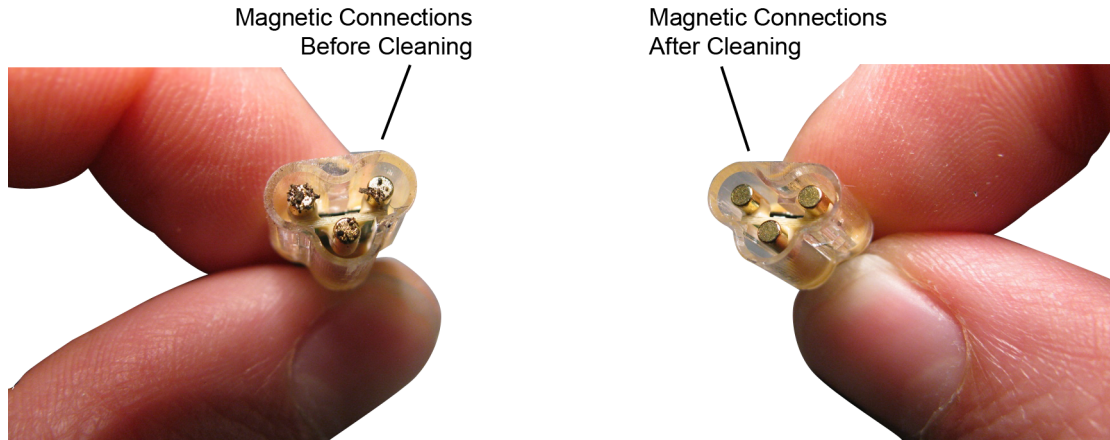
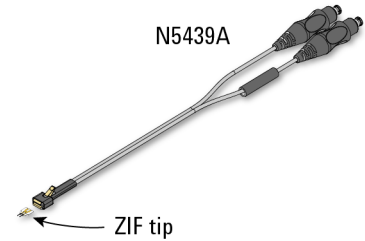

Figure 21 N2848A Head Before and After Cleaning

N5439A InfiniiMax III ZIF Probe Head

The N5439A Zero Insertion Force (ZIF) probe head provides 28 GHz bandwidth. The head supports three types of economical replaceable tips which are shown in **Table 4**. Solder as many tips onto your DUT as needed. Because of the ZIF tip’s extremely low loading, the tips can remain on the DUT as you easily move the probe head from one probing site to the next.



For information on mechanically securing the probes to protect your equipment and designs from damage, refer to **“Strain Relieving the Probe Heads”** on page 53.

Table 4 Available ZIF Tips

ZIF Tip	Description	Variable Tip Spacing	Qty
N2838A	25 GHz 450Ω PC board tip provides robust design with high bandwidth.	5 mil to 250 mil (0.127 mm to 6.35 mm).	5
N5440A	28 GHz 450Ω ceramic (normal sensitivity) for extremely low probe loading.	5 mil to 80 mil (0.127 mm to 2 mm).	5
N5447A	28 GHz 200Ω ceramic high-sensitivity for extremely low probe loading.		

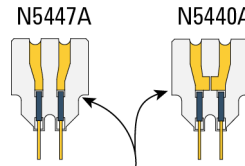
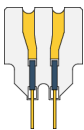
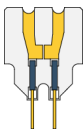
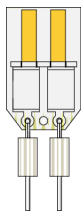

These ZIF tips have different gold patterns

NOTE The N5439A does not include any ZIF tips. You must order either the N2838A, N5440A, or N5447A in addition to N5439A.

NOTE  To install or repair the N2838A resistor leads, refer to **“Replacing Axial Resistor Tips”** on page 56.

NOTE For performance plots, refer to **Chapter 7**, “Performance Plots.”

Ensuring Maximum N2838A Tip Performance

The specifications and performance plots of the N2838A ZIF tip were measured with a nominal spacing of 40 mil (1 mm). In order to achieve the proper response as shown in the performance plots, keep the mini-axial lead resistors roughly parallel as shown in **Figure 22**, and use the tip wires on the mini-axial leads to get the desired span.

If you need to position the resistors different than shown in this figure (that is, resistor bodies close together or spread apart), use Keysight's N2807A and N2808A PrecisionProbe products to perform an AC calibration of the probe, which properly captures the response. Increasing the spacing to 250 mil degrades the performance some, but PrecisionProbe can be used to compensate or qualify the effect.

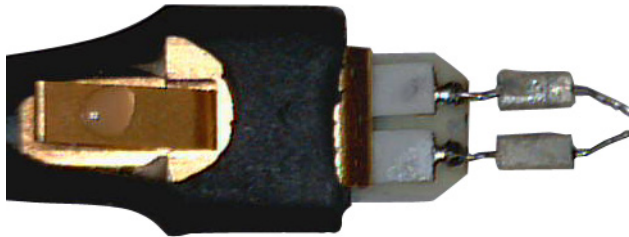

Figure 22 Proper Position of Resistors

Soldering a ZIF Tip to the DUT

CAUTION

The ZIF tips are very fragile. They must be manufactured in this way in order to meet the high-performance, high bandwidth applications they are intended for. Be extremely careful when handling.

- 1 Break off a ZIF tip/handle combination from the packaging holder at the point shown in the figure.

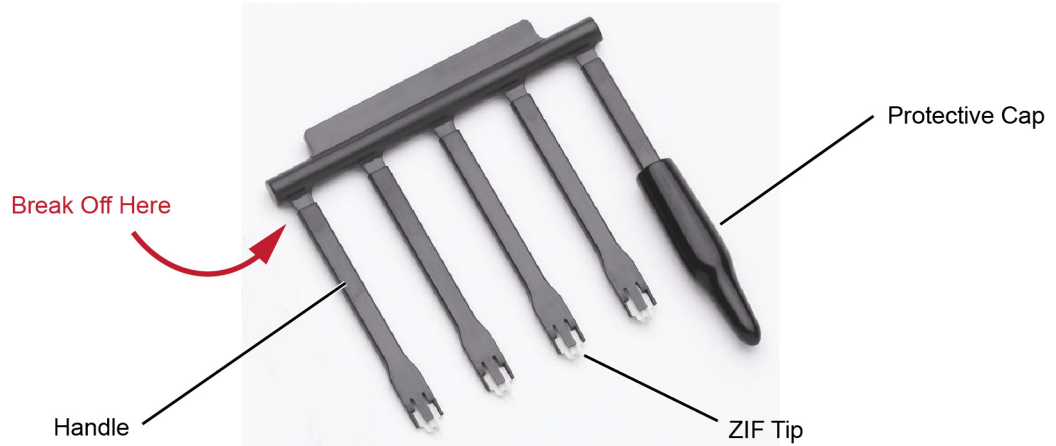

Figure 23 Five ZIF Tips on Packaging

- 2 Flux and tin the leads on the target DUT.

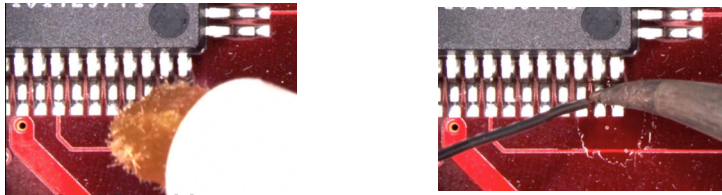

Figure 24 Preparing the DUT Leads

- 3 While holding the plastic form, form the ZIF tip wires to match the DUT's pitch and angle.
- 4 Flux the ZIF tip wires and DUT leads.
- 5 Position the ZIF tip with the gold traces facing up as shown in **Figure 25** and carefully re-flow the solder. This orients the tip so that it will properly mate with the probe head.

NOTE

When soldering the tip to your DUT, use the tip handle to hold the tip. This allows you to position these small tips without damaging them.

CAUTION

Do not dwell on this solder joint.

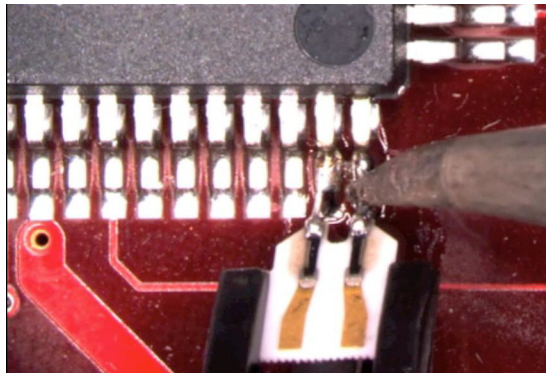

Figure 25 Soldering the ZIF Tip

- 6 Pull the ZIF handle from the ZIF tip in the direction shown in **Figure 26**. ZIF tips can be carefully handled with your fingertips and reinserted into a plastic handle if necessary.

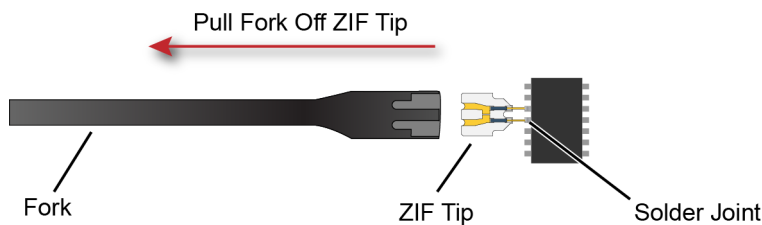

Figure 26 Removing the Handle from the ZIF Tip

- 7 You can connect ZIF tips to any of the locations on a DUT that you need to probe. The probe head can be quickly moved between the tips.

CAUTION

Always mechanically strain-relieve the ZIF head *before* using to protect both your probe accessories and DUT from damage. Refer to **“Strain Relieving the Probe Heads”** on page 53.

CAUTION

Be careful not to damage the tip wires when handling the ZIF tips. Wires can be carefully reshaped with tweezers or fingers if necessary.

Connecting the Probe Head to the ZIF Tip

- 1 Add strain relieve for the ZIF probe head as described in **“Strain Relieving the Probe Heads”** on page 53.
- 2 Form the coaxial cables to bring the probe head near the tip. Press the lever down on the ZIF probe head (see **Figure 27**) and slide the probe head onto the tip. Pressing on this lever removes the clamping force of the connector and enables you to insert or remove ZIF tips.

CAUTION

Stop if you encounter any resistance at all when sliding the probe head over the ZIF tip. Check your alignment, make sure the lever is pressed, and try again. Inserting the ZIF tip should require **“zero”** insertion force.

CAUTION

Always use the lever when inserting or removing ZIF tips.

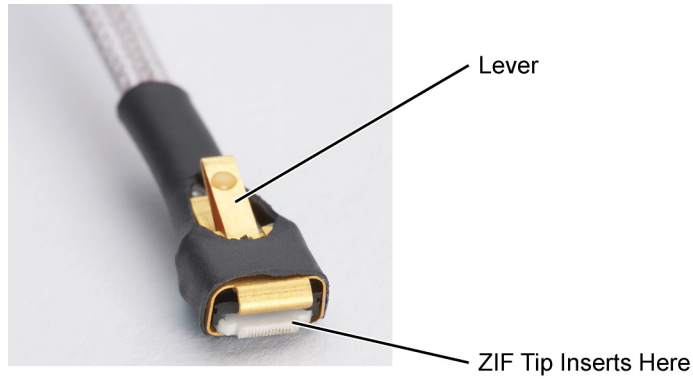

Figure 27 Probe Head with Location of the Lever

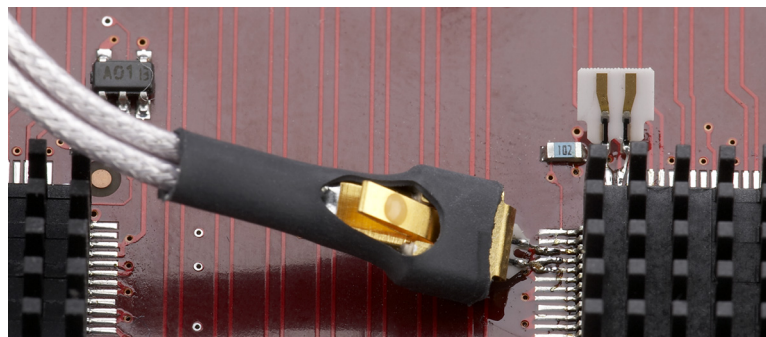

Figure 28 Probe Head Connected to a Soldered ZIF Tip

NOTE

For more repeatable results, orient the probe connection perpendicular to the device as shown in [Figure 29](#).

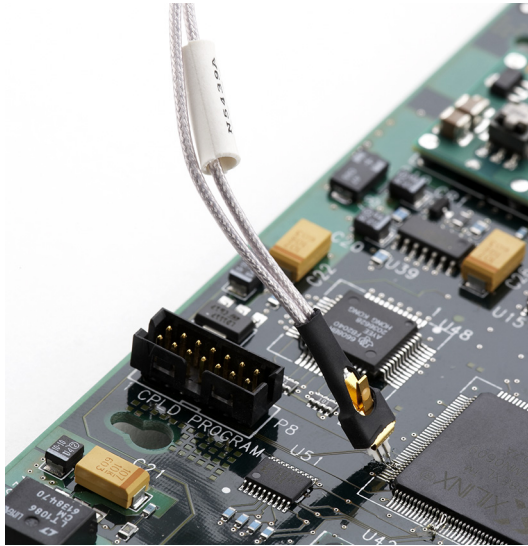

Figure 29 Probe Oriented Perpendicular to Device

- 3 To move the probe head to a different tip, press the lever and remove the probe head from the ZIF tip. The ZIF tip remains soldered to the DUT. Then, simply connect the ZIF head to another ZIF tip at a different location on the DUT.

NOTE

You can use tweezers to actuate the lever in tight places.

MX0109A and N2836A InfiniiMax III Solder-in Probe Heads

The following two solder-in probe heads are available for InfiniiMax III amplifiers.

- MX0109A Extreme Temperature Solder-in probe head
- N2836A InfiniiMax III Solder-in probe head

These probe heads are economical semi-permanent connections that provide up to 26 GHz of system bandwidth.



Figure 30 MX0109A and N2836A InfiniiMax III solder-in probe heads

The following table highlights the key features of these probe heads.

MX0109A	N2836A
<p>Supports testing in extreme temperature ranges. Can withstand -55°C to $+150^{\circ}\text{C}$ temperature range for up to 750 test cycles. Refer to the topic “Extreme Temperature Testing with MX0109A Probe Head” on page 43 to know more.</p>	<p>Can withstand -40°C to $+85^{\circ}\text{C}$ temperature range.</p>
<p>InfiniiMode capable. InfiniiMode allows you to make differential, common mode, and single ended measurements without having to re-solder the tip leads. To use the InfiniiMode capability of these probe heads, use these with InfiniiMax III+ series probe amplifiers.</p>	
<p>The span of leads can be adjusted from 5 mil - 250 mil (0.127 mm - 6.35 mm).</p>	
<p>User replaceable resistor leads. To know how to install / repair resistor leads, refer to “Replacing Axial Resistor Tips” on page 56.</p>	
<p>MX0109A and N2836A have different S parameters stored in the oscilloscope's firmware. On selecting the probe head in the oscilloscope's Select Probe Head dialog box, the appropriate S parameter file for the probe head is loaded. This file is used in conjunction with the probe amplifier's S parameters to compute the overall probe correction for your measurement case.</p>	

NOTE

The minimum required Infiniium software version for the MX0109A probe head is as follows:

- 10.10 or higher (for Infiniium UXR-Series oscilloscopes)
- 6.40 or higher (for all other compatible oscilloscopes)

NOTE

Refer to [Table 10](#) on page 65 and [Table 11](#) on page 67 to know about the characteristics of these probe heads.

For performance plots, refer to “[MX0109A and N2836A 26 GHz Solder-In Probe Heads \(with N2803A\)](#)” on page 109.

Ensuring Maximum Performance for MX0109A / N2836A Probe Heads

Tip Spacing

The specifications and performance plots of the MX0109A and N2836A probe head were measured with a nominal spacing of 40 mil (1 mm). In order to achieve the proper response as shown in the performance plots, keep the mini-axial lead *resistors* roughly parallel as shown in [Figure 31](#), and use the tip wires on the mini-axial leads to get the desired span.

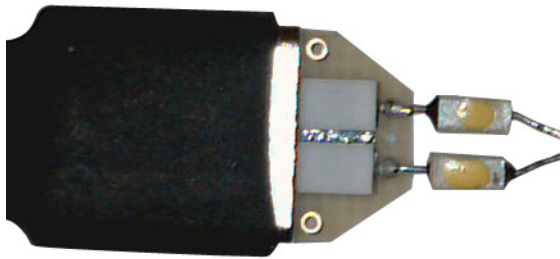

Figure 31 N2836A With 1 mm Tip Spacing

If you need to position the mini-axial lead resistors different than shown in this figure (that is, resistor bodies close together or spread way apart), use Keysight’s N2807A and N2808A Precision Probe products to perform an AC calibration of the probe. The AC calibration will capture the response properly. Increasing the spacing to 250 mil will degrade the performance some, but Precision Probe can be used to compensate or qualify the effect.

CAUTION

The axial resistors on the N2836A and MX0109A probe heads are fragile. They must be manufactured in this way in order to meet the high-performance, high bandwidth applications they are intended for. Be careful when handling.

Best Practices for MX0109A and N2836A Connection to DUT

— Best Practices —

- ◆ Probe single-ended and differential signals. Do not solder ground leads to ground lead vias as is done with InfiniiMode probing.
- ◆ For single-ended signals, orient the probe head vertically. Laying the probe head flat causes coupling to the tip that can degrade the performance.
- ◆ For single-ended signals, connect the “-” lead to ground.

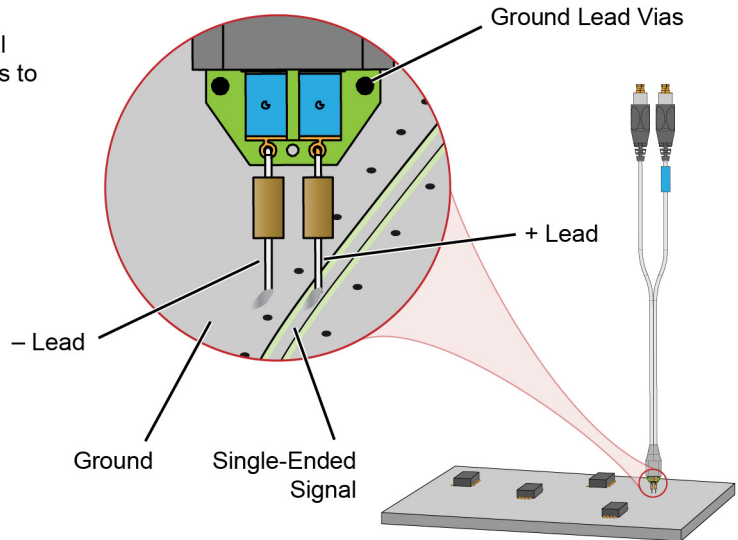

Figure 32 Probe Head Connection to DUT

Soldering the MX0109A / N2836A Probe Head to the DUT

To solder the probe head to your DUT, complete the following steps. This procedure does not show soldering the ground leads, but the same techniques as described in this procedure are used.

CAUTION

Always mechanically strain-relieve the probe head to protect both your probing equipment and DUT from damage. Refer to **“Strain Relieving the Probe Heads”** on page 53.

- 1 Apply flux to your target leads as shown in **Figure 33**.

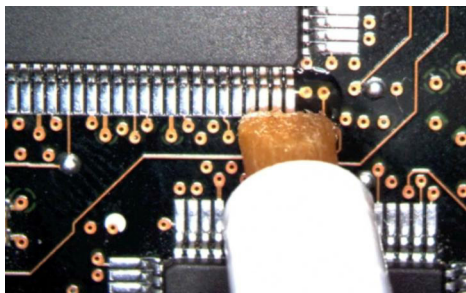

Figure 33 Applying Flux

- 2 Tin the leads with a small amount of solder.

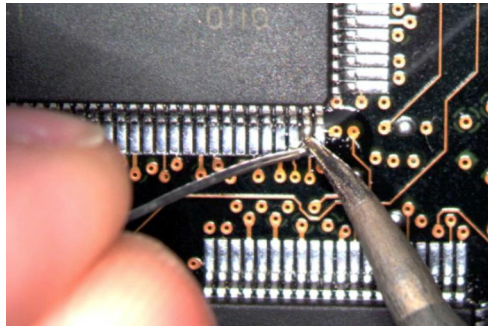

Figure 34 Tin the Leads

- 3 Use tweezers to form the probe head wires to fit your DUT's geometry.
- 4 Flux the DUT leads and your probe head wires.

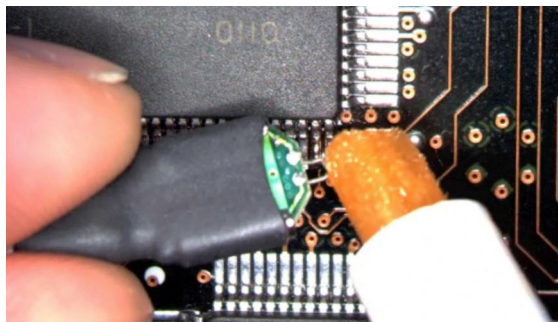

Figure 35 Applying Flux to Leads and Wires

- 5 Position the probe head wires on the DUT leads and quickly re-flow the solder as shown in [Figure 36](#).

CAUTION

Do not leave the iron in contact with the probe head for more than a few seconds at a time.

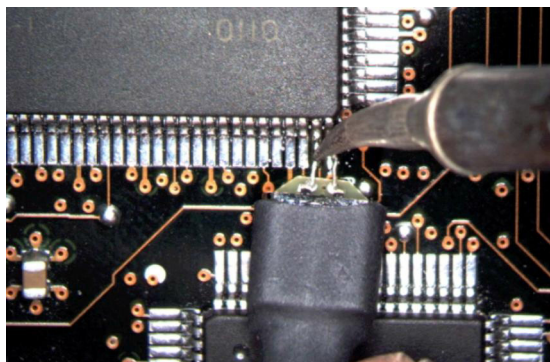

Figure 36 Positioning Wires

Extreme Temperature Testing with MX0109A Probe Head

The MX0109A probe head can withstand temperatures from -55°C to $+150^{\circ}\text{C}$ thereby making it suitable for extreme temperature environments such as temperature chambers. For extreme temperature testing, use the MX0109A probe head with the N5450B InfiniiMax extreme temperature extension cable.



CAUTION

InfiniiMax probe amplifiers cannot withstand extreme temperatures (-55°C to $+150^{\circ}\text{C}$) that the MX0109A probe head can withstand. Be cautious not to subject these probe amplifiers to extreme temperatures. Using the N5450B extension cable with the MX0109A probe head physically separates the amplifier from the probe head and therefore eliminates the chances of the amplifier's exposure to extreme temperatures.

Probe Head Configuration	Operating Temperature Range ($^{\circ}\text{C}$)	Expected Lifetime of the Probe Head (cycles)
MX0109A <i>(attached to the N5450B extension cable)</i>	-55°C dwell, 1000 hours minimum $+150^{\circ}\text{C}$ dwell, 1000 hours minimum -55°C to 150°C cycles, 750 cycles minimum (as per JEDEC JESD22-A104 revision E)	>750

To ensure a high-quality measurement, the N5450B cable set have been phase-matched at the factory. A coupling tag is included with the cables to ensure the cables stay as a matched pair. To install the coupling tag, slip the small end of each cable through the holes in the tag. The tag can be positioned anywhere along the length of the cable and can withstand the temperature ranges specified.

CAUTION

Avoid rapid changes in temperature that can lead to moisture accumulating in the form of condensation on the probe components, as well as the DUT. If this occurs, wait until the moisture has evaporated before making any measurements.

CAUTION

Additional care must be taken when handling probe heads used during extreme temperature cycling because this process makes the probe heads less robust.

CAUTION

Secure the ends of the extension cable near the probe head in the temperature chamber such that the probe head legs are not tugged or moved around significantly.

CAUTION

Prevent abrasion and tears in the cable's jacket. Do not rest the extension cables on any metal objects or objects with sharp edges.

CAUTION

Do not kink the cables. The cables are designed to be flexible, but are not designed to be bent sharply.

NOTE

Keep your extreme temperature testing probes separate from the probes used under milder conditions. This is because cycling probe heads through extreme temperature ranges has a marked effect on their lifetimes. Only the lifetime of the probe head is affected by temperature cycling. The extension cables and probe amplifier should not need to be replaced with extended temperature cycling.

The MX0109A probe head components may undergo discoloration when used under high temperatures. Such changes do not, however, affect the probe head's performance or measurement quality. The probe head maintains its specified frequency response and bandwidth over the operating temperature range (-55°C to $+150^{\circ}\text{C}$), without any need for compensation or correction.



MX0109A - Before usage under high temperatures

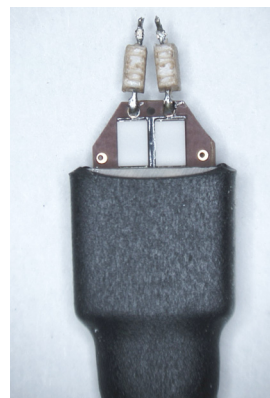

MX0109A - After usage under high temperatures

N5441A InfiniiMax III Solder-in Probe Head (Discontinued)

The N5441A InfiniiMax III solder-in probe head is an economical semi-permanent connection that provides up to 16 GHz of system bandwidth. The span of the leads can be adjusted from 5 mil - 80 mil (0.127 mm - 2 mm).

The N5441A probe head can be used with the N5450B InfiniiMax extreme temperature extension cable. It can withstand the -55°C to +150°C extreme temperature range (for up to 250 test cycles).

CAUTION

When using the N5450B extension cable, do not subject the InfiniiMax III probe amplifier or probe head (other than the N5441A solder-in probe head) to extreme temperatures.



Figure 37 N5441A InfiniiMax III solder-in probe head

CAUTION

The wires on the N5441A are fragile. They must be manufactured in this way in order to meet the high-performance, high bandwidth applications they are intended for. Be careful when handling.

For information on mechanically securing the probes to protect your equipment and designs from damage, refer to [“Strain Relieving the Probe Heads”](#) on page 53.

NOTE



To install or repair the tip wires on the N5441A, refer to [“Replacing N5441A Probe Head Wires”](#) on page 59.

Soldering the Probe Head to the DUT

To solder the probe head to your DUT, complete the following steps. The procedure is very similar to that for the ZIF probe tips used with the N5439A probe head.

- 1 Position the probe head near the location on the DUT where you want to solder the probe.
- 2 Add strain relieve for the probe head as described in [“Strain Relieving the Probe Heads”](#) on page 53.
- 3 Apply flux to your target leads as shown in [Figure 38](#).

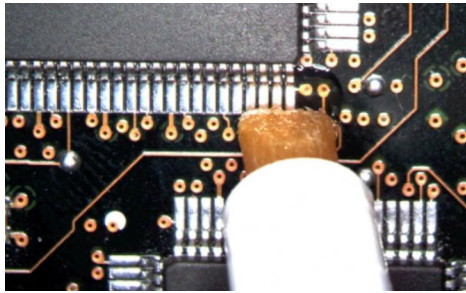

Figure 38 Applying Flux

- 4 Tin the leads with a small amount of solder.

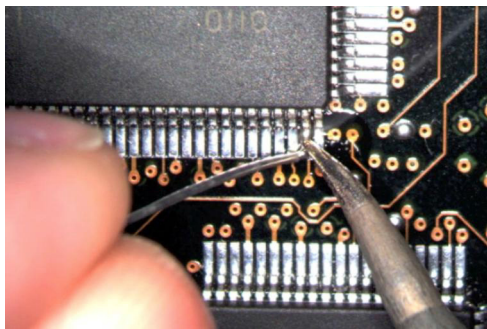

Figure 39 Tin the Leads

- 5 Use tweezers to form the probe head wires to fit your DUT's geometry.
- 6 Flux the DUT leads and your probe head wires.

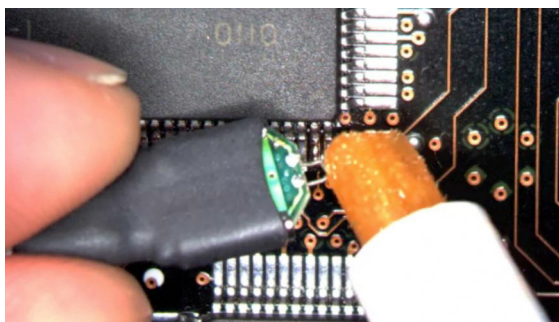

Figure 40 Applying Flux to Leads and Wires

- 7 Position the probe head wires on the DUT leads and quickly re-flow the solder as shown in [Figure 41](#).

CAUTION

Do not leave the iron in contact with the probe head for more than a few seconds at a time.

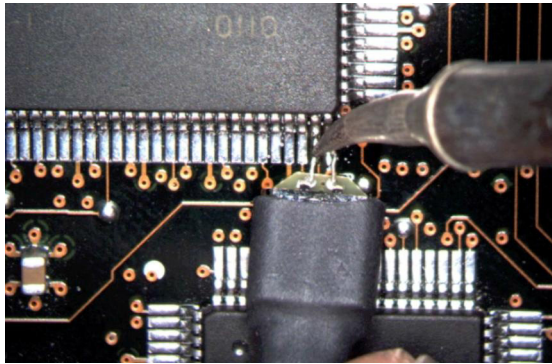

Figure 41 Positioning Wires

N5444A InfiniiMax III 2.92 mm / 3.5 mm / SMA Probe Head

The N5444A InfiniiMax III 2.92 mm/3.5 mm/SMA probe head provides 30 GHz bandwidth and allows you to connect two 2.92 mm, 3.5 mm, or SMA cables to make a differential measurement on a single oscilloscope channel.

The N5444A provides for a termination to a common DC voltage rather than to ground, which is required for many signal standards. It is implemented such that from DC to approximately 1 kHz, the termination is 55 Ohms to the termination voltage, and above approximately 10 kHz, the termination is 50 Ohms to 0.9 times the termination voltage. The termination voltage range is $\pm 4V$ with a minimum step of 5 mV and a maximum current of 80 mA.



Figure 42 N5444A InfiniiMax III 2.92mm/3.5mm/SMA Probe Head with the N5444-61601 Termination Voltage Cable

You can control the termination voltage of the N5444A probe head using:

- either the oscilloscope software.
- or the supplied N5444-61601 cable connected to your own DC power supply. You may want to use an external power supply if this aspect of your test system is automated or you want finer control over the voltage than what the oscilloscope software interface provides.

NOTE

When the N5444-61601 cable is connected to the $\pm 4V$ input connector on the InfiniiMax III probe's pod, the internal termination voltage is deactivated. Any voltage applied to the banana leads on the N5444-61601 cable is buffered to protect the probing system from inadvertent damage. A DC voltage between $\pm 4V$ should be applied across the banana leads. You can verify the termination voltage by probing the lugs on the N5444A probe head with a DVM.

N5448B Coaxial Phase Matched Cable Pair

For extending the cable length of the N5444A InfiniiMax III probe head and add flexibility and convenience to the probing setup, you can order N5448B 10 inches (25 cm) long coaxial phase matched cable pair. This cable pair supports 2.92 mm male-to-2.92 mm male connection.

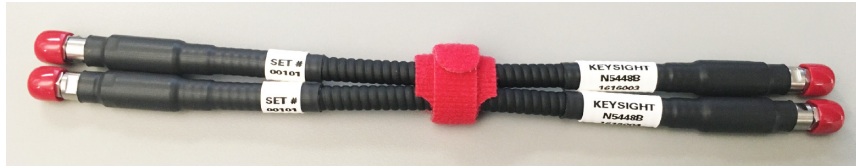

Figure 43 N5448B Coaxial Phase Matched Cable Pair

Before connecting these cables to the N5444A probe head, you must first remove the supplied rigid cables of the N5444A probe head. **Figure 44** on page 49 shows the N5448B cables attached to the N5444A probe head.

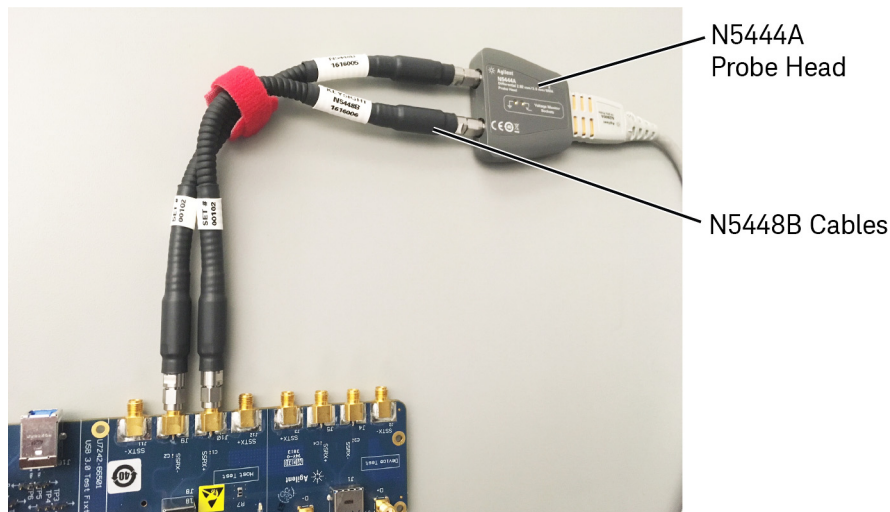

Figure 44 N5444A Probe Head With N5448B Cables Attached

CAUTION

The maximum bend radius for the N5448B coaxial cable pair is 30 mm. Bending these cables at too tight a radius or twisting the cables can cause damage, reduce performance, and impact the precision of these cables.

Also, ensure that the plastic caps that are provided with these cables are installed when the cables are not in use.

For details on the N5448B cable, refer to its guide available in the Document Library tab of this product's page on www.keysight.com.

Probe Offset Calibration with the N5444A

To achieve more accurate probe offset calibration with the N5444A, an SMA shorting adapter (Keysight part number: 1250-3999) is required. This adapter is provided with the N5444A (with unit serial number US50072545 or higher) and should be connected to the N5444A's "-" input connector during the calibration.



The latest Infiniium firmware includes instructions on the Probe Calibration dialog box to remind you to install the adapter. If the Infiniium oscilloscope's firmware is older than version 5.50.33, you can still attach the adapter and the resulting calibration will be valid.

N2835A InfiniiMax III Differential Connectivity Kit and Accessories

In addition to the individual probe heads described in the previous topics, the N2835A differential connectivity kit is also available for the InfiniiMax III probes.

This kit provides multiple quantities of the four InfiniiMax III probe heads as shown in **Figure 45**. You can order this kit either at the same time as InfiniiMax III probe amplifiers or separately later.

N2836A Differential Solder-In
(quantity 2)

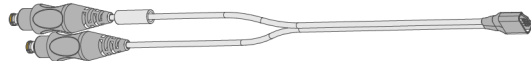

N5439A Differential ZIF Solder-In
(quantity 2)

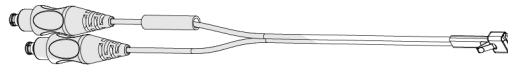

N2848A QuickTip
(quantity 2)

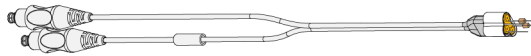

N5445A Differential Browser
(quantity 1)

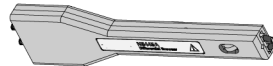

Figure 45 Probe Heads Included in the N2835A Differential Connectivity Kit (*not to scale*)

Table 5 Supplied Accessories (Sheet 1 of 2)

Description	Qty Supplied	Part Number
N2836A InfiniiMax III 26 GHz Differential Solder-In Probe Head	2	N2836A
Replacement Axial Resistors Kit	10	N2836-68701
N5439A InfiniiMax III 28 GHz Differential ZIF Solder-in Probe Head	2	N5439A
N2838A InfiniiMax III 25 GHz ZIF Tip Kit	2 kits (5 tips in each kit)	N2838A
N2848A InfiniiMax III QuickTip Probe Head	2	N2848A
N2849A InfiniiMax QuickTip Tips Kit	2 kits (4 tips in each kit)	N2849A
N5445A InfiniiMax III Browser Probe Head	1	N5445A
Replacement Tips	4	N5476A
Tweezer for replacing tips	1	N5445-23801
Screw Driver	1	N5445-23802
Protective End Cap	1	N5445-44101

Table 5 Supplied Accessories (Sheet 2 of 2)

Description	Qty Supplied	Part Number
Ground Blades	4	N5445-68700

Strain Relieving the Probe Heads

High-performance probes have small physical geometries to ensure the lowest possible loading and best electrical response. Because of their small size, probing accessories are often delicate. It is important to mechanically secure your probes to protect both your equipment and designs from damage. There are several methods that Keysight recommends:

Tack-putty

Keysight recommends the use of tack-putty for securing both probe heads and amplifiers. Wrap a small amount of tack-putty around your probe head cables, taking care to not pinch them. The mass can then be secured to a rigid body near your DUT.

A similar techniques can be used to secure probe amplifiers where you apply some tack-putty to the underside of the probe amplifier body and attach it to a rigid body near your DUT.

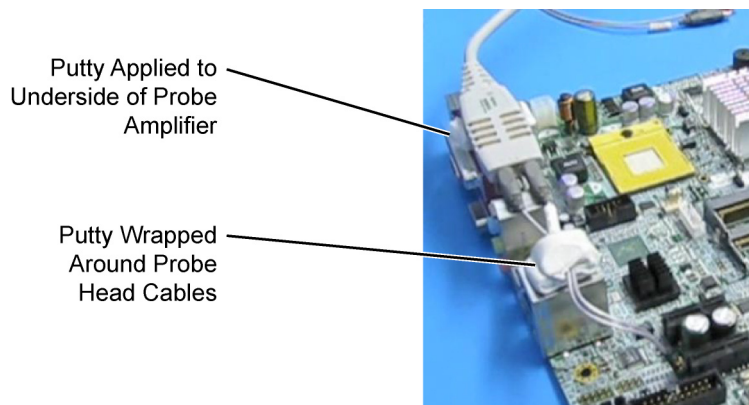

Figure 46 Using tack-putty to strain relieve a probe head and amplifier

You can also use putty with a positioner, such as the Keysight N2787A. The same positioner can also be used to support your probe amplifier as shown in [Figure 18](#) on page 28.

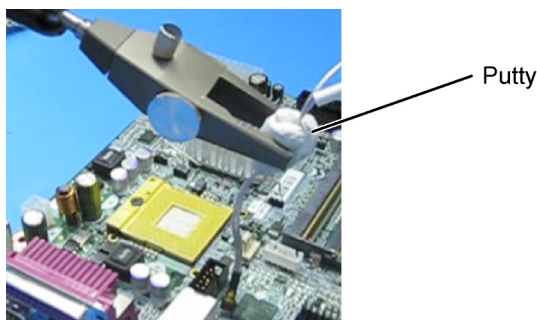

Figure 47 Using putty with the N2787A 3D Probe Positioner

Low-temperature Hot Glue

You can also use low-temperature hot glue to secure cables.

CAUTION

Only use LOW temperature hot glue. To remove the hot glue, warm it with a heat gun set on low. Only heat the hot glue enough to remove it.



Figure 48 Using low-temperature hot glue to secure a probe head

General Tips on Strain Relief

Keep in mind that different accessories have different cable stiffness. You should choose a strain relief method appropriate for the cable stiffness. For instance, it is best to secure the stiffer N5439A near the SMP connectors and form the cable to the optimal location.

Other strain-relief options like tape or hook-and-loop work fine as well, but keep the following guidelines in mind to protect your probing investment.

CAUTION

Do not kink cables. Do not crush cables. Do not use aggressive adhesives or high temperatures.

Table 6 Replaceable Parts

Part	Part Number
Extra wire (for solder-in probe head only)	01169-81301 (7 mil)
	01169-21306 (5 mil)
Strain Relief Putty	N5439-65201

3 Maintaining Probe Heads

Replacing Axial Resistor Tips **56**

Replacing N5441A Probe Head Wires **59**

Many probe heads come equipped with replaceable resistor or wire tips which can be replaced or repaired. Using the procedures in this chapter, you can extend the life of the following items:

- MX0109A probe heads
- N2836A probe heads
- N5441A probe heads
- N2838A ZIF tips

CAUTION

Do not replace or repair the N2849A QuickTip's resistor or ground leads. Attempting to do so will damage the ability of the tip to mate with the N2848A probe head.

Replacing Axial Resistor Tips

The procedure in this sections shows you how to replace the 130 ohm axial resistors that are located at the tip of the:

- MX0109A solder-in probe head
- N2836A solder-in probe head
- N2838A ZIF tip

These resistors can become worn or damaged with use. Order the replacement axial resistor kit (N2836-68701) which provides 10 resistors.

NOTE

The pictures in the following procedure show the N2836A solder-in probe head, but the same procedure applies to the MX0109A and N2838A ZIF tip.

Recommended Equipment

- Vise or clamp for holding tip.
- Metcal STTC-022 (600 °C) or STTC-122(700 °C) tip soldering iron or equivalent. The 600 °C tip will help limit burning of the FR4 tip PC board.
- 0.381 mm (0.015 in) diameter RMA flux standard tin/lead solder wire.
- Fine stainless steel tweezers.
- Rosin flux pencil, RMA type (Kester #186 or equivalent).
- Diagonal cutters.
- Magnifier or low power microscope.
- Ruler.

CAUTION

As the probe heads and tips are easily damaged, only experienced soldering technicians should attempt this repair.

Procedure

- 1 As shown in **Figure 49**, clamp the probe head or ZIF tip in a vise. Tweezers can be used to hold the probe head or ZIF tip away from the vise. When using tweezers, grip the tip either on the sides or top and bottom.

CAUTION

When tightening the vise, use light force to avoid damaging the solder-in probe head.

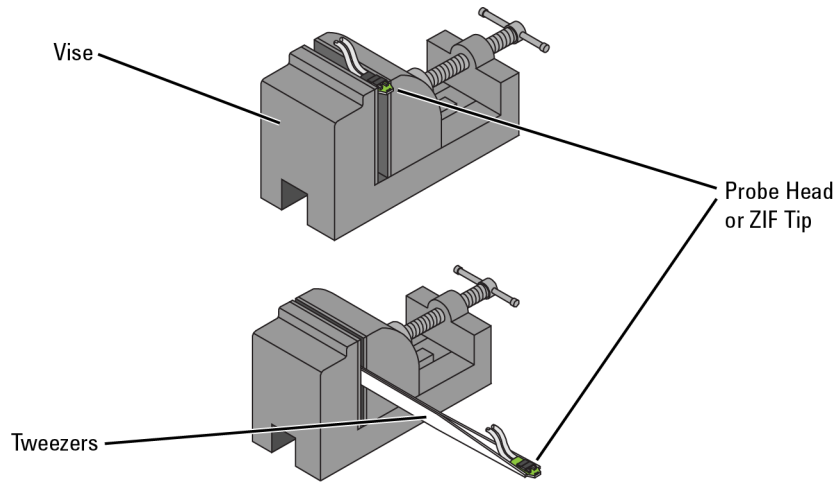

Figure 49 Clamping the Part

- 2 Grab each resistor lead or wire with tweezers and pull very gently up. Touch the soldering iron to solder joint just long enough for the resistor to come free of the probe head tip.



Figure 50 Removing the Resistor

NOTE

Clean the soldering iron tip of any excess solder before using.

NOTE

The solder joint has very low thermal mass so the joint will quickly melt and release.

CAUTION

To limit burning and damage to the PC board, do not keep the soldering iron in contact with the tip any longer than is necessary.

CAUTION

Excessive dwell time with the iron will permanently damage the flip-chip resistor.

- 3 Use the soldering iron and solder to fill the holes in preparation for mounting the new resistors (or wires).

CAUTION

Do not leave the iron in contact with the tip any longer than necessary.

- 4 Use the flux pencil to coat the solder joint area with flux.
- 5 Locate the trim gauge which is supplied with the N2836-68701 replacement axial resistor kit.
 - a Place a resistor over the lead length gauge shown in **Figure 51**. Trim the leads to match the drawing. The orientation of the lead is not important.
 - b Place a resistor over the bend gauge and bend the leads to match the drawing. This bend fits in the hole in the tip's PC board.

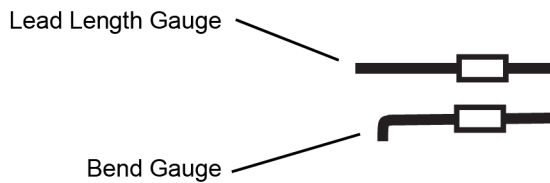

Figure 51 Trim Gauge

- 6 Holding the resistor lead or wire in one hand and soldering iron in the other, position the end of the resistor lead (after the 90 degree bend) over the solder filled hole.

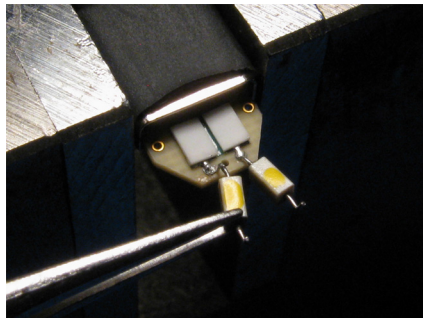

Figure 52 Soldering in a new axial resistor

- 7 Touch the soldering iron to the side of the hole. When the solder in the hole melts, the resistor lead will fall into the hole.

CAUTION

Remove the soldering iron as soon as the lead falls into the hole.

NOTE

Because the thermal mass of the joint is very small, extra dwell time with the soldering iron is not needed to ensure a good joint.

- 8 Using a digital volt meter, measure the resistance from the coax center conductor to the resistor tip. The DC resistance should measure 450 ohms.

Replacing N5441A Probe Head Wires

Use the following procedure to install or replace the wire leads on the N5441A solder-in probe head. Depending on your probing application, you can order either 5 mil or 7 mil wire as listed in the following table. For example, use the 5 mil wire for attaching to small vias.

Table 7 Required Wire Type

Wire Diameter	Part Number
0.007 inch (tin-plated nickel wires)	01169-81301
0.005 inch (tin-plated nickel wires)	01169-21306

Table 8 Recommended Equipment

Equipment
Vise or clamp for holding tip
Metcal STTC-022 (600 °C) or STTC-122 (700 °C) tip soldering iron or equivalent. The 600 °C tip will help limit burning of the FR4 tip PC board.
0.381 mm (0.015 in) diameter RMA flux standard tin/lead solder wire
Fine stainless steel tweezers
Rosin flux pencil, RMA type (Kester #186 or equivalent)
Flush cutting wire cutters
Magnifier or low power microscope
Keysight supplied trim gauge (01169-23801)

Procedure

- 1 Use the vise or clamp to position the tip an inch or so off the work surface for easy access.

CAUTION

If using a vise, grip the tip on the sides with light force. When tightening the vise, use light force to avoid damaging the solder-in probe head. If using a tweezers clamp, grip the tip either on the sides or at the top and bottom.

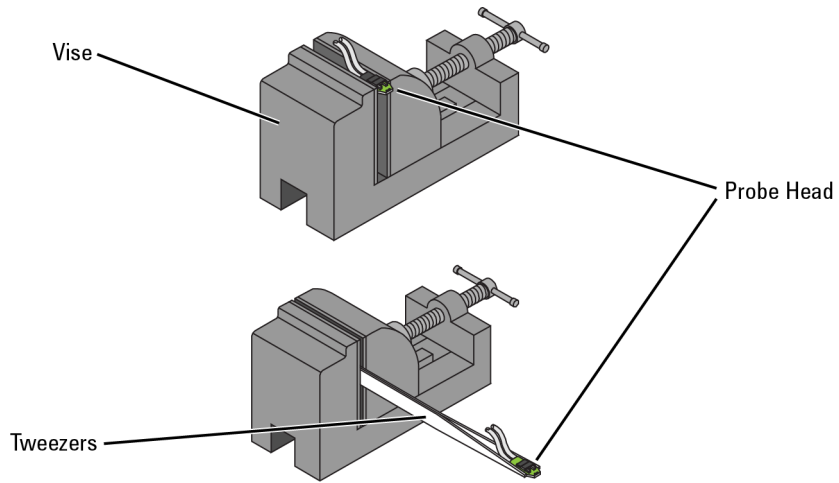

Figure 53 Clamping the Probe Head

- 2 As shown in **Figure 54**, remove the old wires with tweezers while re-flowing the solder from the underside of the probe.

CAUTION

Apply heat quickly to avoid damaging your probe.

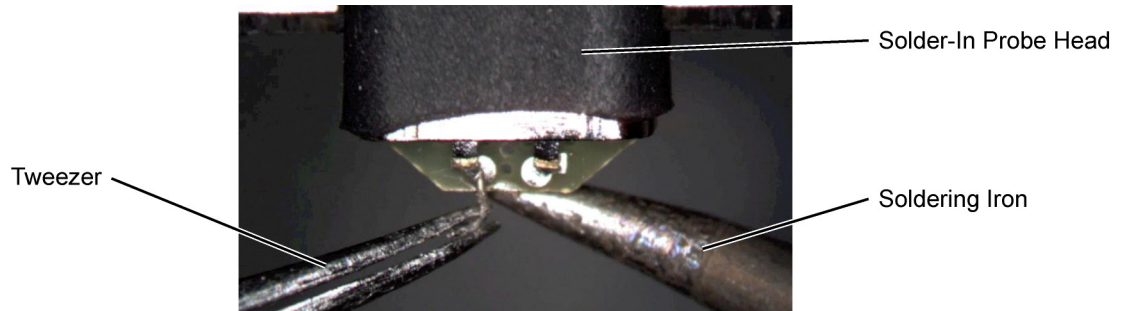

Figure 54 Removing the Old Wire

- 3 If necessary, add a small amount of solder to the holes and apply flux.

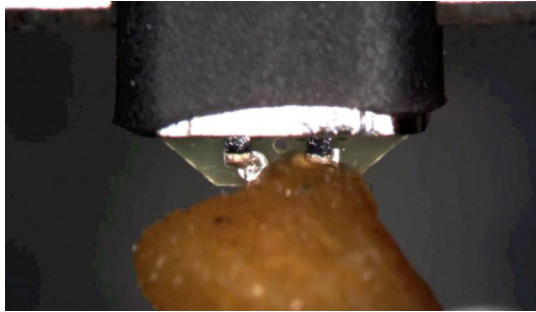

Figure 55 Adding Solder and Flux

- 4 Re-flow the solder from the underside and insert a new piece of wire. It is best to shape the wire into an “L” before attempting to insert.

CAUTION

Do not dwell with the iron in contact with the probe head.

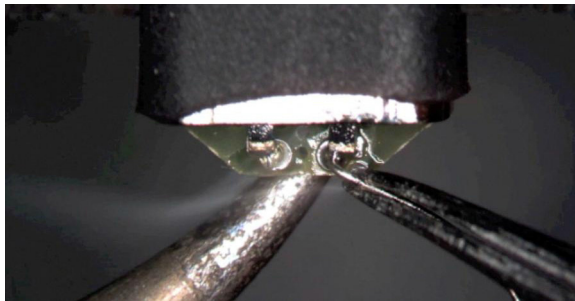

Figure 56 Adding a New Wire

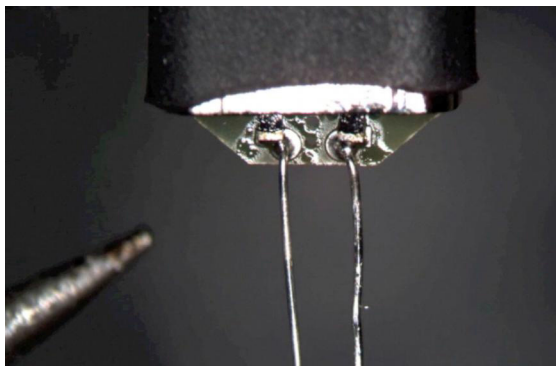

Figure 57 New Wires Properly Attached

- 5 Trim any wire stubs on the probe head underside.

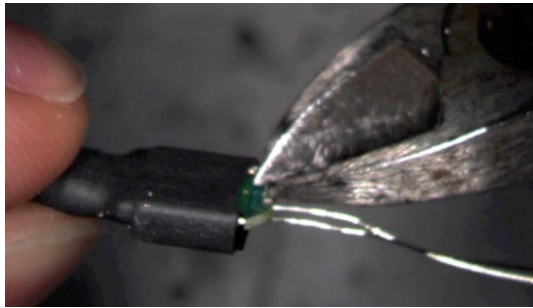

Figure 58 Trim Wire Stubs

- 6 Use the included trim gauge to cut the wire lengths. Doing so ensures the best performance from your probe head.

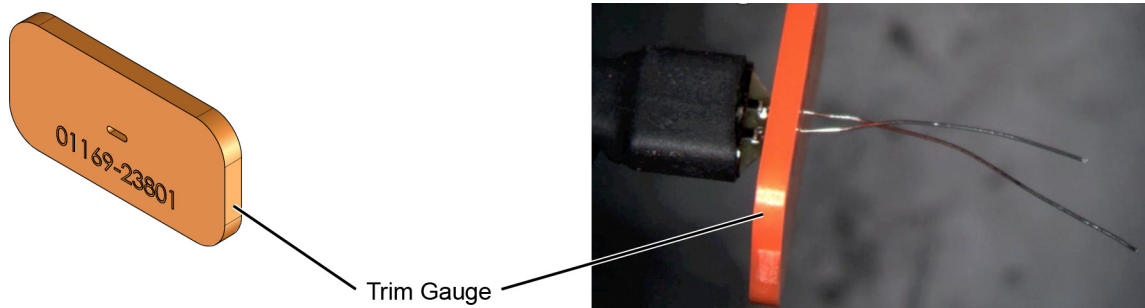

Figure 59 Trim Gauge Placed on Wires

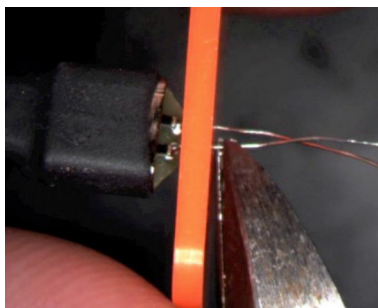

Figure 60 Removing Excess Wire

- 7 Check the DC resistance of each probe leg when you have replaced the wires. The correct resistance should be 450 ohms.

4 Performance Specifications / Characteristics

InfiniiMax III Warranted Specifications	64
N2800A/1A/2A/3A Probe Amplifiers Characteristics	65
InfiniiMax III Probe Heads Characteristics	67
InfiniiMax III Probe Heads Dimensions	68
Environmental Specifications	72
Safety Specifications	73

NOTE

All entries included in this chapter are characteristics unless otherwise noted. These are the typical performance values of the InfiniiMax probes using the InfiniiMax III probe amplifiers and each different probe head except otherwise specified.

Bandwidth and DC input resistance (R_{se} and R_{diff}) are the only specifications.

The InfiniiMax III series probe amplifiers and probe heads are designed to be used within the temperature range of the 90000-X series oscilloscope. The only exception are the N5441A and MX0109A solder-in probe heads. The temperature range for these probe heads is from -55°C to $+150^{\circ}\text{C}$ for up to 250 test cycles (for N5441A) and 750 test cycles (for MX0109A). These are compatible with the N5450B InfiniiMax extreme temperature extension cable.

InfiniiMax III Warranted Specifications

Table 9 Warranted Specifications

Probe Head	Probe Amplifier	Bandwidth	DC Input Resistance
N5439A ZIF probe head with N5440A ceramic 450 Ω ZIF tip	N2803A 30 GHz probe amp	26 GHz	$R_{diff}=100\text{ k}\Omega \pm 2\%$, $R_{se}=50\text{ k}\Omega \pm 2\%$
N5445A 450 Ω browser	N2803A 30 GHz probe amp	28 GHz	$R_{diff}=100\text{ k}\Omega \pm 2\%$, $R_{se}=50\text{ k}\Omega \pm 2\%$

N2800A/1A/2A/3A Probe Amplifiers Characteristics

The characteristics listed in **Table 10** are mainly determined by the N2800A/1A/2A/3A probe amplifiers.

Table 10 InfiniiMax III Probe Amplifier Characteristics (Sheet 1 of 2)

Feature	InfiniiMax III Probe Amplifier		
	With 450 Ω Probe Heads (N5439A, N5445A, N5441A, N2838A, N2836A, MX0109A, N2848A)	With 200 Ω Probe Heads (N5447A ZIF tip with N5439A ZIF probe head)	With N5444A 2.92 mm / 3.5 mm / SMA Probe Head
DC Input Resistance	$R_{se} = 50 \text{ k}\Omega \pm 2\%$ each input to ground $R_{diff} = 100 \text{ k}\Omega \pm 2\%$ $R_{cm} = 25 \text{ k}\Omega \pm 2\%$	$R_{se} = 50 \text{ k}\Omega \pm 2\%$ each input to ground $R_{diff} = 100 \text{ k}\Omega \pm 2\%$ $R_{cm} = 25 \text{ k}\Omega \pm 2\%$	55 Ω to V_{term}
Input Resistance (> 10 KHz)	$R_{se} = 500 \text{ }\Omega \pm 2\%$ each input to ground $R_{diff} = 1 \text{ k}\Omega$ $R_{cm} = 250 \text{ }\Omega$	$R_{se} = 500 \text{ }\Omega \pm 2\%$ each input to ground $R_{diff} = 1 \text{ k}\Omega$ $R_{cm} = 250 \text{ }\Omega$	50 Ω to $0.901 * V_{term}$
Input Voltage Range (Differential or Single Ended)	1.6 Vpp, ± 0.8 Vp mains isolated (HD2&3 < -38 dbc), 2.5 Vpp, ± 1.25 Vp mains isolated HD2&3 < -34 dbc)	0.8 Vpp, ± 0.4 Vp mains isolated (HD2&3 < -38 dbc), 1.6 Vpp, ± 0.8 Vp mains isolated (HD2&3 < -34 dbc)	1.6 Vpp, ± 0.8 Vp mains isolated (HD2&3 < -38 dbc), 2.5 Vpp, ± 1.25 Vp mains isolated (HD2&3 < -34 dbc)
Maximum Input Power	N/A	N/A	125 mW calculated with the following equation for each input: $P_{max} = \frac{(\text{rms}(V_{in} - V_{term}))^2}{55}$
Input Common Mode Range	± 12 VDC, ± 1.25 V > 250 Hz mains isolated	± 6 VDC to 250 Hz, ± 0.65 V > 250 Hz mains isolated	± 6 VDC to 250 Hz, ± 1.25 V > 250 Hz without violating max input power
DC Attenuation Ratio	6:1	3:1	6:1
Offset Range (for probing a single-ended signal)	±16 V	±8 V	±6 V without violating maximum input power
Input Referred Noise Spectral Density	23.9 nV/rt (Hz)	12.0 nV/rt (Hz)	23.9 nV/rt (Hz)
Input Referred Noise Example	4 mV _{rms} with 28 GHz probe head and 30 GHz probe amp	2 mV _{rms} with 28 GHz probe head and 30 GHz probe amp	4 mV _{rms}

Table 10 InfiniiMax III Probe Amplifier Characteristics (Sheet 2 of 2)

Feature	InfiniiMax III Probe Amplifier		
	With 450 Ω Probe Heads (N5439A, N5445A, N5441A, N2838A, N2836A, MX0109A, N2848A)	With 200 Ω Probe Heads (N5447A ZIF tip with N5439A ZIF probe head)	With N5444A 2.92 mm / 3.5 mm / SMA Probe Head
Maximum Input Voltage	18 V _{peak} mains isolated	18 V _{peak} mains isolated	8 V _{peak} without violating maximum input power

InfiniiMax III Probe Heads Characteristics

The characteristics listed in **Table 11** are for the N2803A 30 GHz probe amplifier using different probe heads. These characteristics are mainly determined by the probe heads.

Performance listed in this table is with the highest bandwidth probe amp (N2803A 30 GHz) model in InfiniiMax III probe family. Performance with lower bandwidth amps (N2800A/1A/2A) is the lower of the following:

- Amplifier BW
- 0.434/Amplifier BW
- .308/Amplifier BW
- bandwidth measured with the highest bandwidth amplifier (N2803A) in the family.

Table 11 Characteristics for Probe Heads Using N2803A Probe Amplifier

Probe Head		Input Capacitance		Mode	Bandwidth (-3 dB)	10 - 90% Transition Time	20 - 80% Transition Time
		C _{diff}	C _{se}				
N5439A ZIF	N5440A 450Ω ZIF tip	32 fF	44 fF	Differential	28 GHz	15.5 ps	11.0 ps
	N2838A 450Ω ZIF tip	95 fF	130 fF		25 GHz	17.4 ps	12.3 ps
	N5447A 200Ω ZIF tip	32 fF	44 fF		28 GHz	15.5 ps	11.0 ps
N5445A 450Ω Browser		35 fF	50 fF		30 GHz	14.5 ps	10.3 ps
N5441A 450Ω Solder-In		77 fF	105 fF		17.2 GHz	34.8 ps	26.6 ps
MX0109A 450Ω Solder-In Head (Vertically orientation with no ground wires) Or (Flat orientation with minimum length ground wires)		108 fF	140 fF		27 GHz	16.1 ps	11.4 ps
N2836A 450Ω Solder-In Head (Vertically orientation with no ground wires) Or (Flat orientation with minimum length ground wires)		108 fF	140 fF		27 GHz	16.1 ps	11.4 ps
N2848A QuickTip (with ground wires connected)	N2849A 450Ω QuickTip	200 fF	340 fF		16 GHz	27.1 ps	19.3 ps
N5444A 2.92 /3.5 mm /SMA		N/A	N/A		30 GHz	15.5 ps	11.0 ps

InfiniiMax III Probe Heads Dimensions

All dimensions included in this section are in millimeters [inches].

MX0109A Extreme Temperature Solder-in Head Dimensions

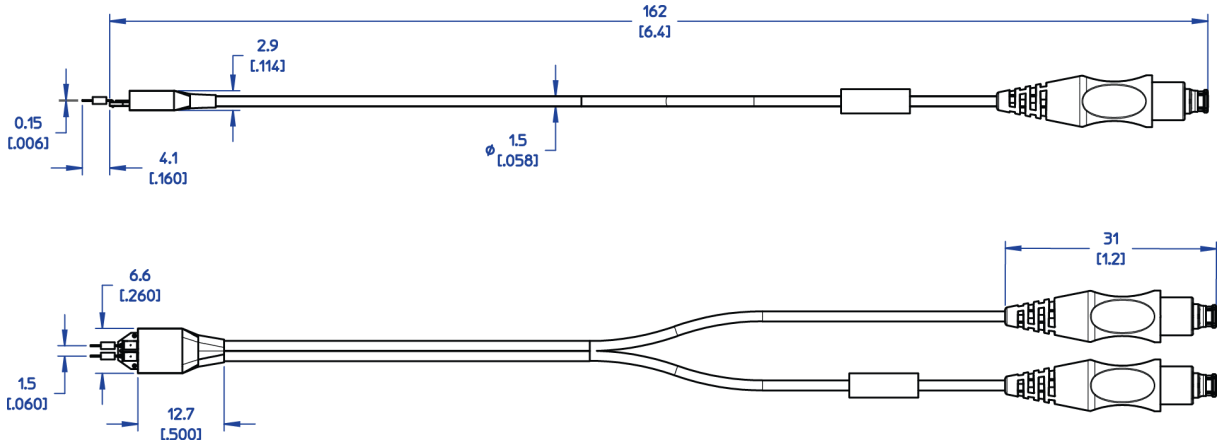

N2836A InfiniiMax III Solder-in Head Dimensions

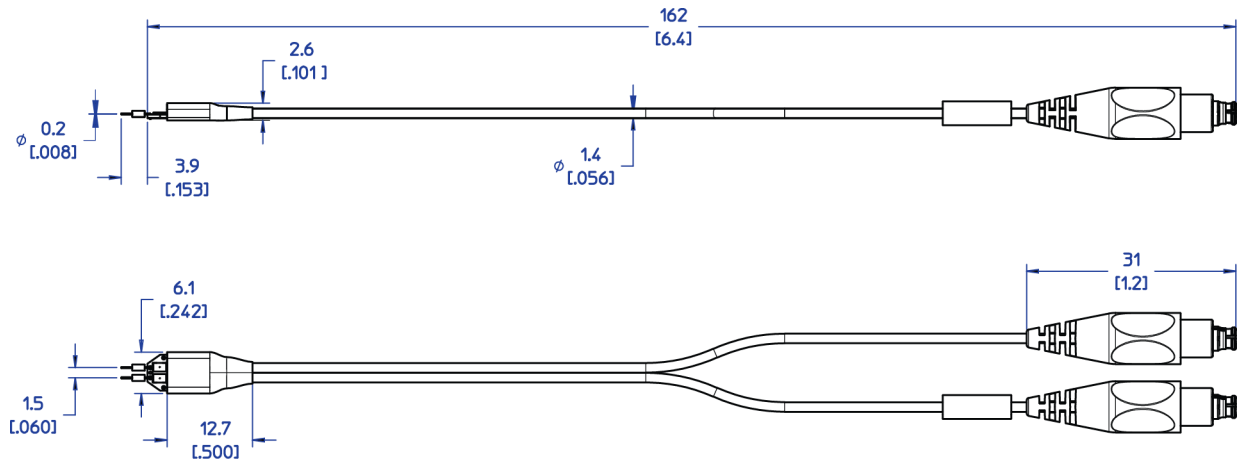

N2838A InfiniiMax III PCB ZIF Tip with N5439A ZIF Head Dimensions

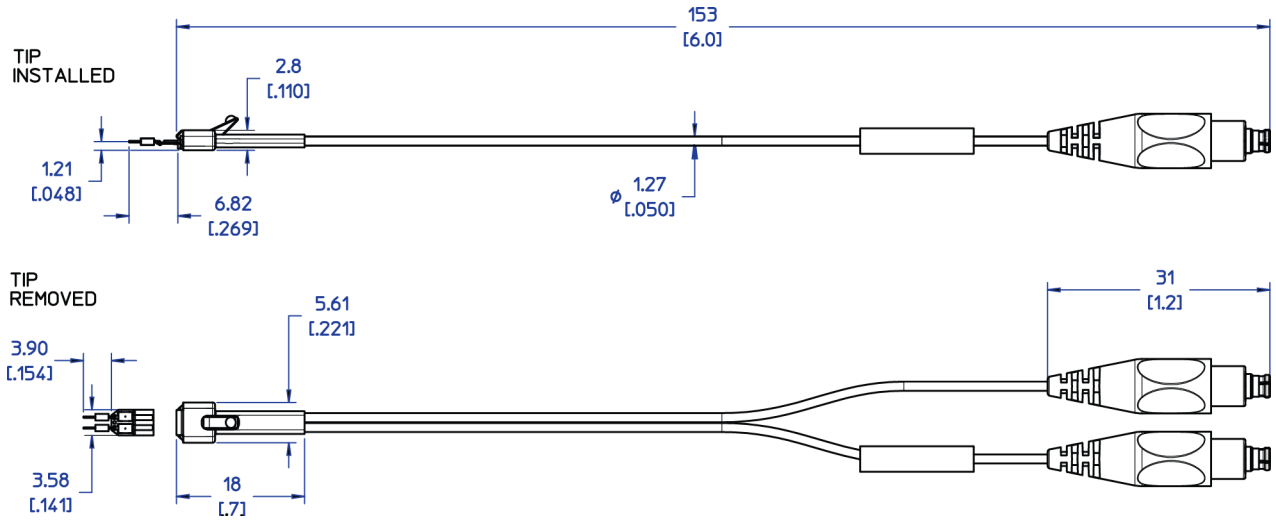

N2848A InfiniiMax III QuickTip Probe Head with N2849A QuickTip Dimensions

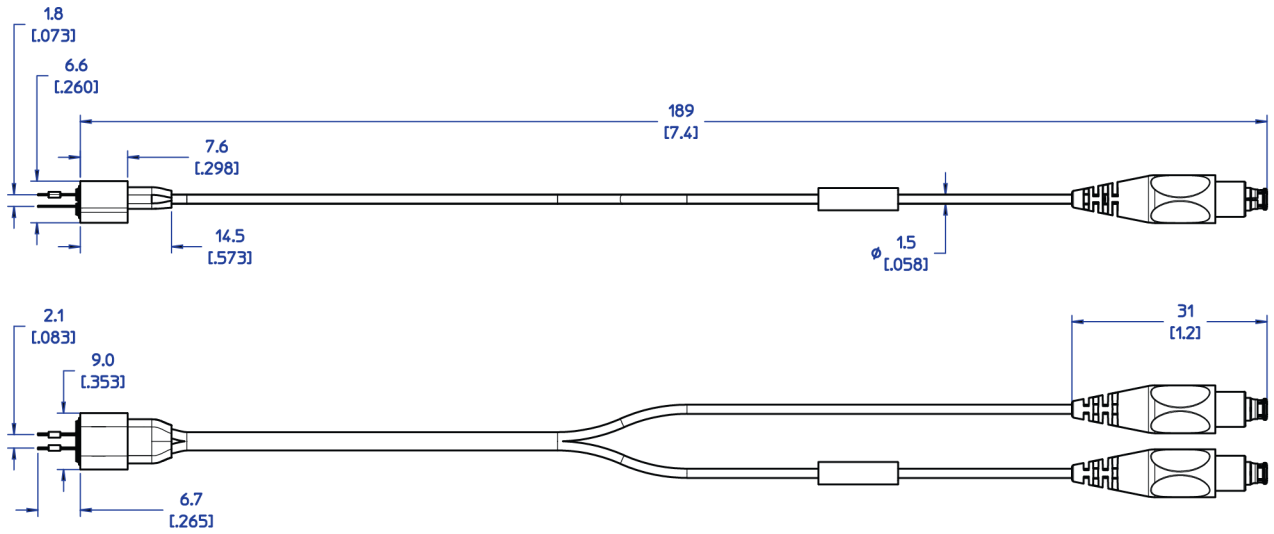

— N2849A QuickTip —

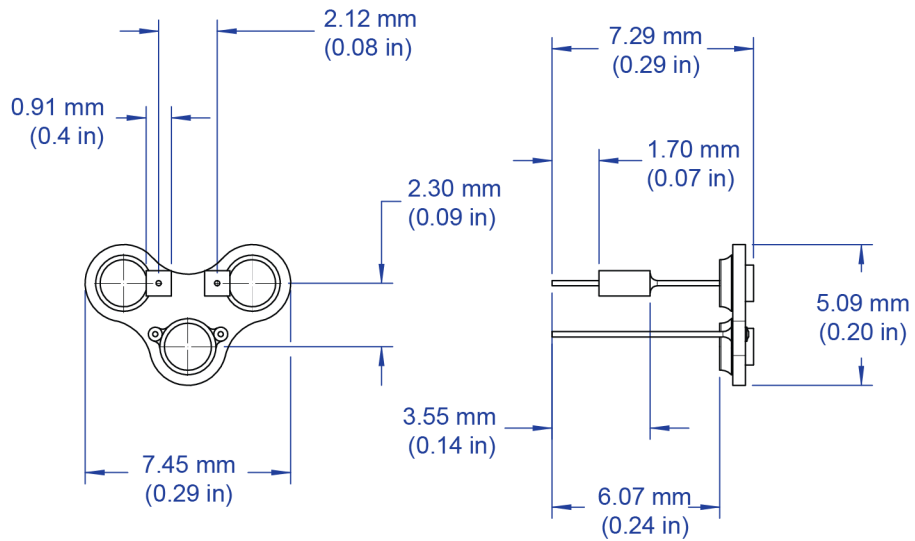

N5440A/N5447A InfiniiMax III Ceramic ZIF Tip with N5439A ZIF Head Dimensions

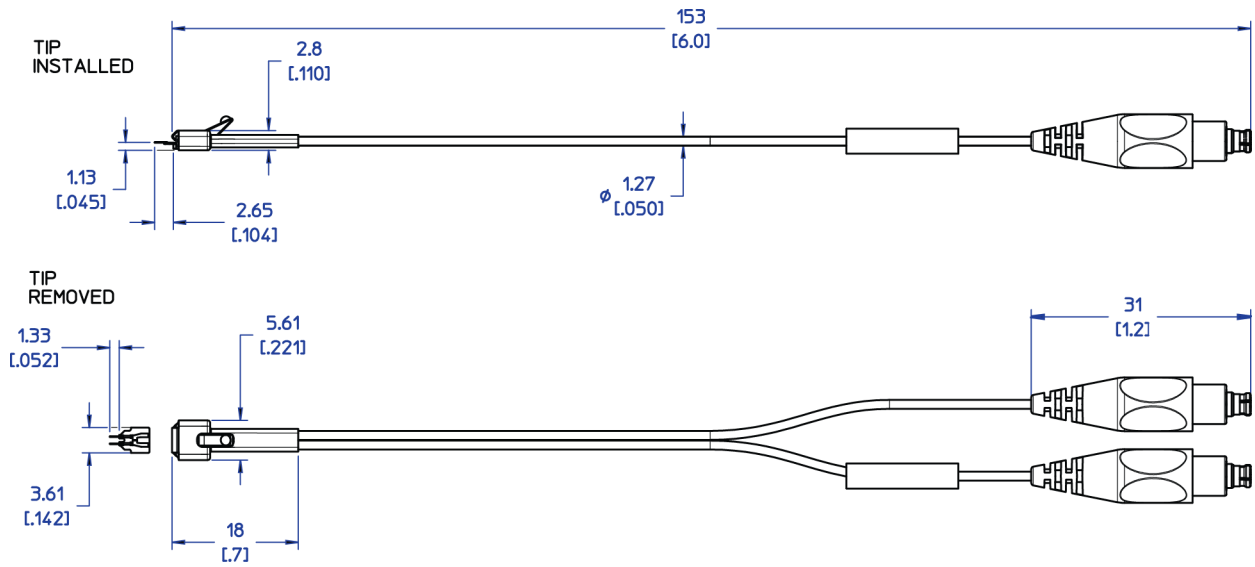

N5441A InfiniiMax III Solder-in Head Dimensions

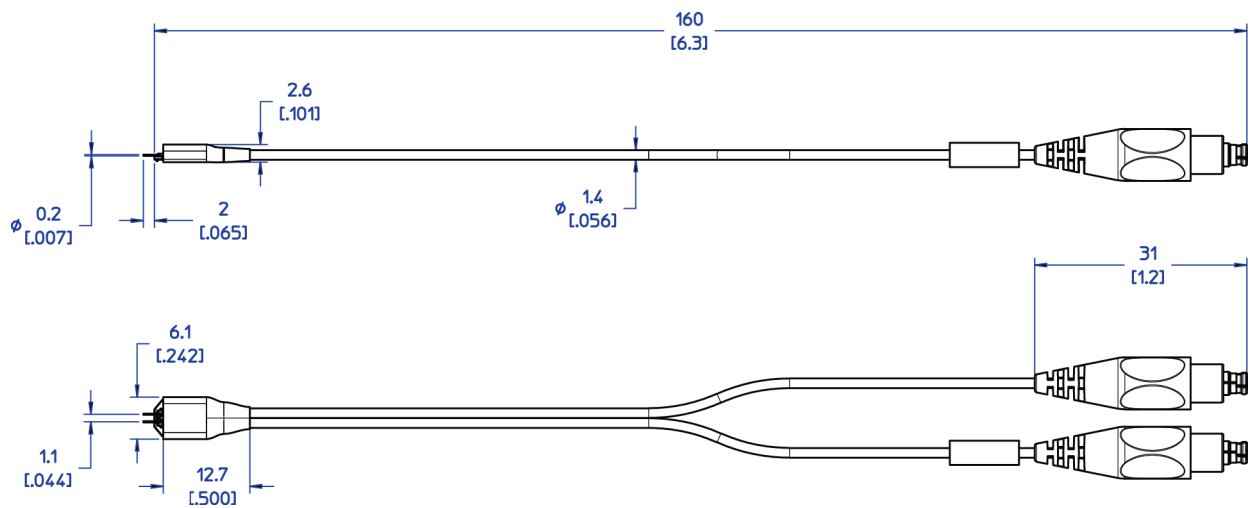

Environmental Specifications

Environmental Condition	Specification
Altitude	2000m
Temperature	Operating: 5 to 40 °C Non-Operating: -40 to 70 °C
Humidity	80% up to 31 °C, decreasing linearly to 50% RH at 40 °C
Pollution Degree	2

Safety Specifications

Compliant to
IEC 61010-031:2015
EN 61010-031:2015

5 Calibration / Deskew Procedure

To perform a calibration/deskew for the InfiniiMax III Probing system, you will be using the N5443A Calibration/Deskew Fixture.

This fixture enables you to not only calibrate / deskew your InfiniiMax III probe, but it also ensures you properly position the probe amplifier during the procedure via the plastic holder. You can remove the plastic holder from the fixture by removing the four screws on the bottom side of the holder if you prefer.



Procedure

NOTE

Allow the probe to warm up for 20 minutes before performing the calibration procedure.

- 1 To perform a DC calibration / calibrated skew, make sure the 50 ohm terminator (included with N5443A) is connected to the fixture as shown below.

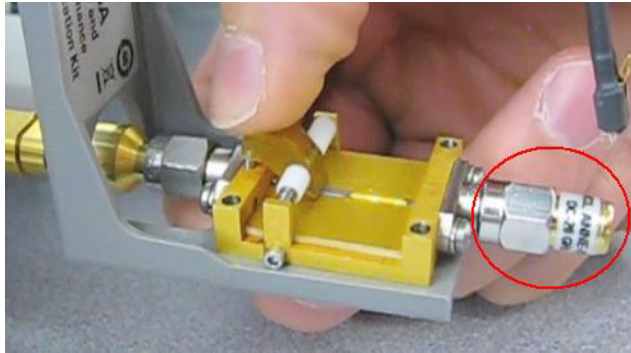

- 2 Hold the N5443A upright and connect the fixture to the Cal Out on the oscilloscope. Turn the nut on the Cal Out counter-clockwise to tighten.



- 3 While holding the fixture upright with one hand, use an 8 in. lbs. torque wrench to fully tighten the connector as shown on the next page.



- 4 Connect the probe amplifier to one of the channel inputs on the oscilloscope.
- 5 Insert the amplifier into the top of the fixture holder. The amplifier can slide up and down in the holder to adjust the probe head position.

CAUTION

Always wear an ESD wrist strap when working with active probes. Not doing so can result in the probe becoming permanently damaged.



- 6 Before connecting to the N5443A fixture, form the N5439A probe head ZIF tip wires as shown below (if using the ZIF tip for the calibration / deskew). If you are using the browser probe head then you do not need to adjust the shape of the tips.



Form the wires as shown below if using the N5441A solder-in probe head.



- 7 Connect your probe head to the amplifier.



- 8 Position the probe head wires (if you are using the ZIF or Solder-in probe heads) so they curl towards the scope as shown below.



- 9 Press the Menu button on the probe amplifier to bring up the Probe Setup dialog box on the oscilloscope.
- 10 In the Probe Setup dialog box, click on the Calibrate Probe ... button. This will open the Probe Calibration dialog box.

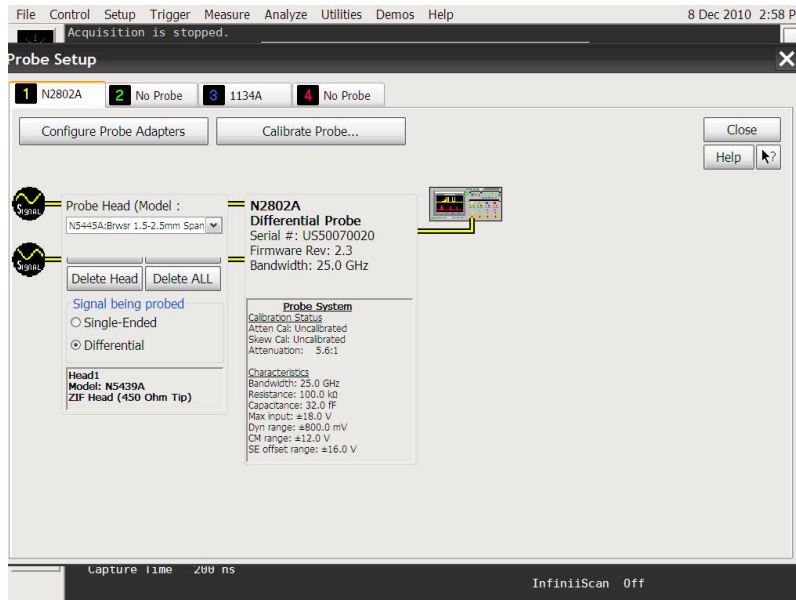

- 11 In the Probe Calibration dialog box, select the probe head you are using in the Head Label (Type) field, select the Calibrated Atten/Offset radio button, and press the Start Atten/Offset Calibration... button.

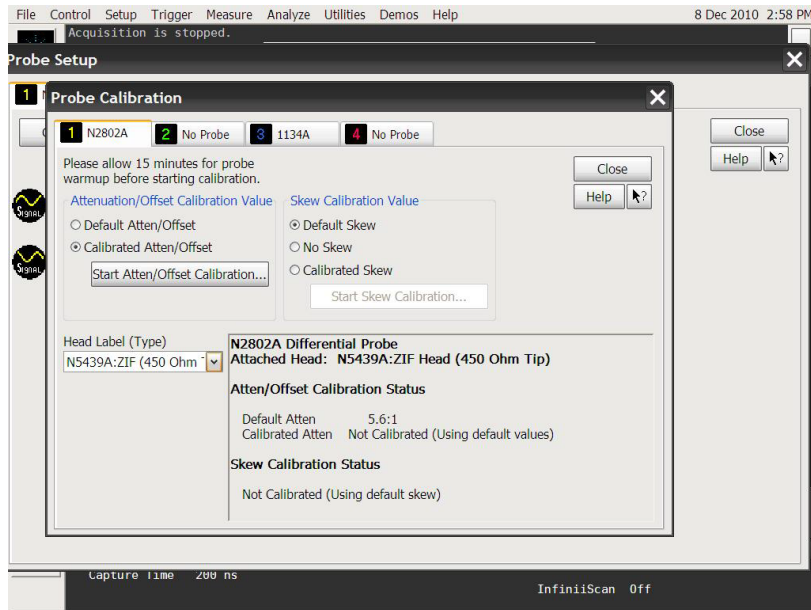

- 12 A dialog box will then open that tells you how to connect the probe head to the calibration/deskew fixture.

NOTE

The fixture has three spring-loaded fingers (shown below) that clamp probe head wires to the fixture if you are using the ZIF probe head or the Solder-in probe head.

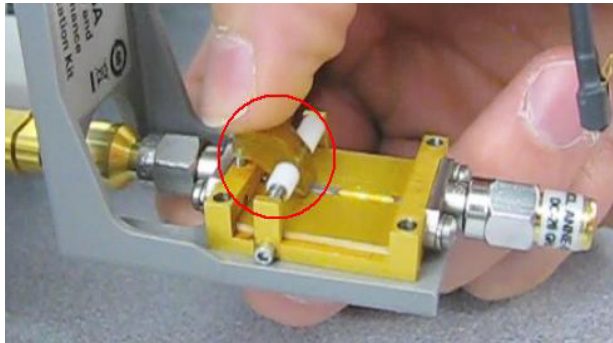

- 13 On the fixture, the center gold trace is signal and the large plates on either side are both ground as shown below.

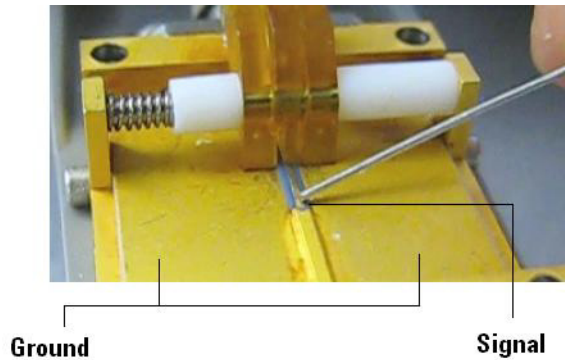
**CAUTION**

Never solder a probe tip to the thickfilm gold. The gold will immediately dissolve into the solder and disappear.

- 14** Follow the instructions on the oscilloscope to clamp the wires to either the signal or ground. When connecting the probe wires to the fixture, press down on the spring-loaded fingers described in Step 12 and insert the probe wires. You can check that the wires are connected correctly by pressing the autoscale button on the front panel and checking that you have a stable step on screen (note that pressing autoscale will close the Probe Calibration dialog box).

NOTE

People tend to have their own preference for this step in terms of the angle to view and insert the probe wires under the spring-loaded fingers. Try different angles to determine your optimum method.

CAUTION

When connecting the probe head to the fixture, do not press down with much force or you could snap off the fixture from the Cal Out connection. Light contact is all that is needed for the calibration.

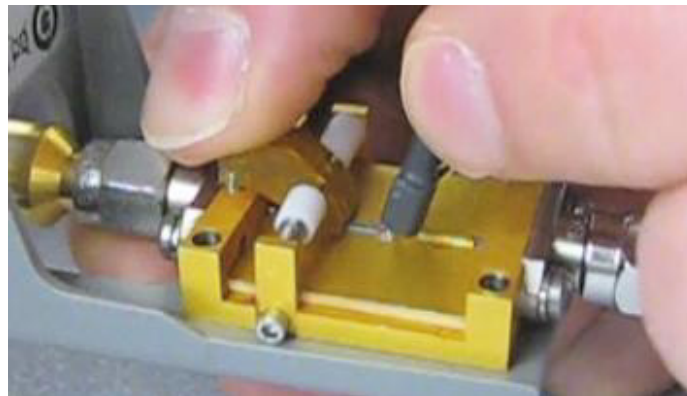

- 15** If you are using the browser probe head, it is recommended that you use the N2787A 3D Probe Positioner to hold the browser in place (as shown below). The browser uses spring-loaded tips so you do not need much force to get a solid contact. You can check that the tips are connected correctly by pressing the autoscale button on the front panel

and checking that you have a stable step on screen (note that pressing autoscale will close the Probe Calibration dialog box).

CAUTION

When connecting the probe head to the fixture, do not press down with much force or you could snap off the fixture from the Cal Out connection. Light contact is all that is needed for the calibration.



- 16 With the probe head correctly connected to the fixture, press OK in the dialog box on the oscilloscope and wait for the calibration to finish. It will report whether the calibration was successful or not.
- 17 Once the calibration has successfully completed, the DC Cal LED on the probe amplifier will turn green indicating that the particular combination of probe amplifier, probe head, and oscilloscope channel input has been calibrated.

NOTE

Any time you use a new probe head type, a new probe amplifier, or a different channel on the oscilloscope, the **DC Cal** LED will be amber, indicating that a DC calibration is required.

- 18 Once the DC vertical calibration has successfully completed, select the Calibrated Skew radio button from the Probe Calibration dialog box on the oscilloscope. Then press the Start Skew Calibration... button and follow the on-screen instructions for the skew calibration.

6 Performance Verification

Bandwidth Performance Verification	84
DC Input Resistance Performance Verification	102
Performance Test Record	105

This chapter describes the equipment and procedures needed to verify the performance of InfiniiMax III probes. Due to the very high frequency of the InfiniiMax III probing system, it is important to carefully adhere to the techniques and procedures described in this chapter to accurately measure the performance.

It is also important to note that the performance measured here is of the probe by itself. Keysight high performance real-time scopes (and sampling scopes under certain conditions) will apply probe correction that will further enhance the performance of the probes.

CAUTION

Electrostatic discharge (ESD) can quickly and imperceptibly damage or destroy high performance probes, resulting in costly repairs. Always wear a wrist strap when handling probe components and insure that cables are discharged before being connected.

Bandwidth Performance Verification

This section documents the bandwidth performance of the N2803A InfiniiMax III Probe Amplifier with the N5439A ZIF probe head and N5440A ceramic ZIF tip or with the N5445A browser probe head.

Keysight recommends a test interval of one year or 2000 hours of operation.

Equipment Needed

- Keysight 2 port E8361A/C Vector Network Analyzer:
 - Or equivalent VNA that covers at least a 50 MHz to 34 GHz range. This procedure is written assuming the E8361A/C PNA. If a different VNA is used, references that are specific to the PNA will need to be modified.
 - Needs proper test port cables and/or adaptors to provide male 2.92 mm connectors at reference planes. If test port cables are 2.4 mm or 1.85 mm cables, then Keysight 11904A and 11904D adaptors can be used to convert to 2.92 mm male connectors.
 - Needs to be capable of using a Touchstone file to de-embed at a port.
 - Needs to have bias port for port 1 of the VNA (i.e. has internal bias T's and a BNC port that allows bias to be applied to port 1)
- Keysight N5443A Performance Verification Fixture.
- Maury Microwave 8775B2 2.92 mm male broadband load, or other 2.92 mm male load with similar or better return loss. A high quality 2.92 mm adaptor to a 2.4 mm or 1.85 mm VNA calibration load with required return loss could be used.
- Keysight N5477A Autoprobe II/3.5 mm Adaptor.
- Keysight 1143A Power supply.
- Keysight 5062-1247 outside thread 3.5 mm (male) to 3.5 mm (female) adaptor.
- Keysight N4692A-00F 2.92 mm (female/female) ECal module. Or, other 2.92 mm calibration kit that can calibrate to the 2.92 mm male connectors at the test ports.
- BNC 50 ohm male terminator or equivalent; not a critical part. For example, Pomona number 3840-50 or 4119-50.
- InfiniiMax III Probe Head. Either the N5439A ZIF probe head with the N5440A ceramic ZIF probe tip or the N5445A browser probe head.

VNA Setup

- Power level: -6 dBm.
- Sweep: Log Frequency 50 MHz to 34 GHz, 284 points (100 pts/decade).
- IF BW: 1 kHz.
- Test port cables and adaptors (if needed) to provide male 2.92 mm connectors at measurement planes.
- Install the BNC 50 ohm terminator to the bias input for port 1 of the VNA (on the rear panel of E8361 PNA). This provides a DC 50 ohm termination for the probe amp output.
- Clear all traces from display, then select S12 to display.
- Set scale for S12 to 3 dB/div, with reference level to 0 dB and reference position to 5 divisions.

Procedure

NOTE

Allow the probe to warm up for 20 minutes before performing the performance verification procedure.

- 1 Calibrate the PNA to the two male 2.92 mm connectors (connectors can be seen in [Figure 62](#)) using the N4692A-00F ECal module (or equivalent 2.92 mm cal kit).

CAUTION

As with all precision connector interfaces, make sure to torque all connections using the proper torque wrench!

- 2 Prepare the N5439A ZIF probe head for connection to the PV fixture as shown in [Figure 61](#).
 - a Install a N5440A ceramic ZIF tip into the N5439A ZIF probe head. Make sure it is fully inserted.
 - b Bend the tip wires down at their halfway point using fine tweezers.
 - c Slightly spread the tips wires to better match the spacing needed for the PV fixture.

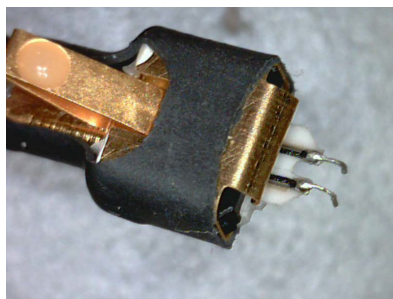

Figure 61 N5439A ZIF Probe Head

- 3 Connect the 1250-1749 adapter and N5443A PV fixture assembly to the calibrated ports of the PNA as shown in **Figure 62**. A small bench vise is useful to hold PV fixture steady.

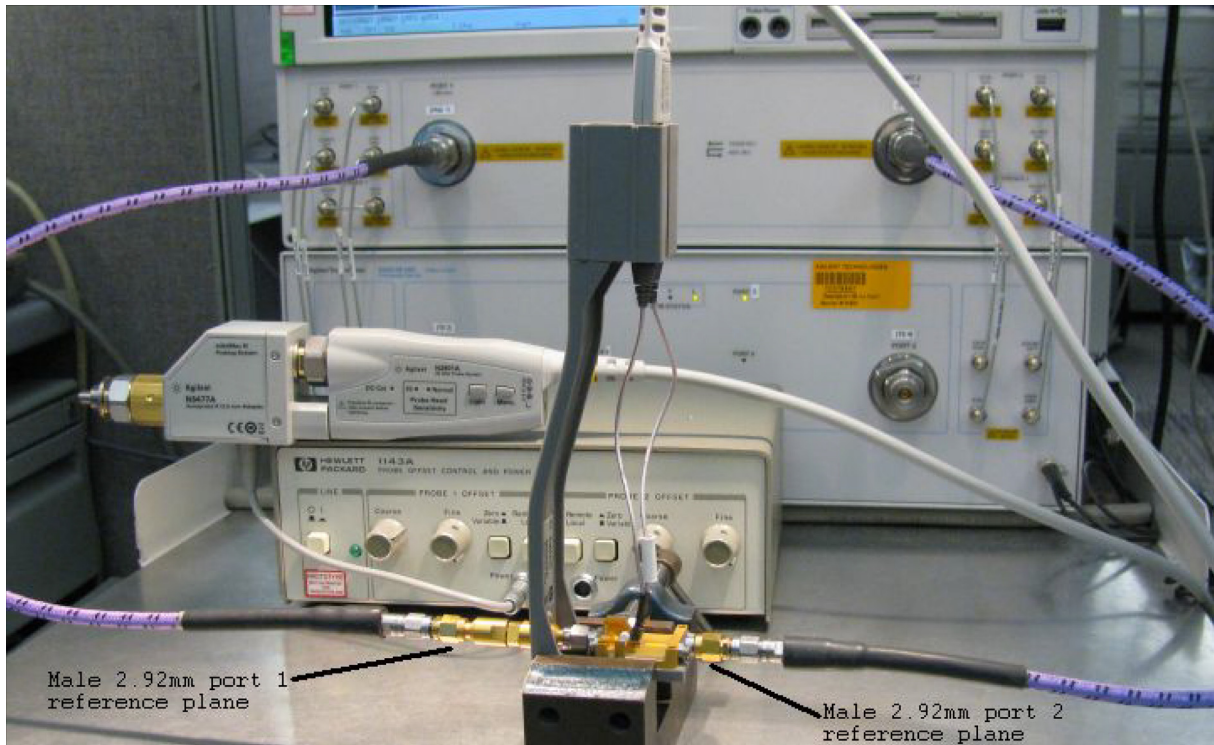

Figure 62 Setup for measuring “Vin” of probe

- 4 Connect the N5477A AutoProbe II adapter to the 1143A power supply and turn on the power supply.
 - a Make sure the probe offset control button on the 1143A is set to “Zero” so no probe offset is applied.
 - b The 5062_1247 adapter should be attached to the N5477A and properly torqued.
- 5 Connect the probe amp pod end to the N5477A and torque connector.
- 6 Connect the probe to the N5443A PV fixture:
 - a Probe amp with ZIF probe head is inserted into the PV holder far enough that the tip wires can easily reach the pinchers on the PV fixture.
 - b Form the coax cables so that the tip wires are close to the pincher points before trying to connect the tip wires. The connectors between the probe head and the probe amp can be rotated to align the probe tip properly to the pinchers. Since the center trace of the PV fixture is above the ground plane,

the probe head should be tipped slightly so the tip wires touch the center trace and ground plane at the same time.

- c Depress the actuators on the pinchers and carefully insert one wire under the center pincher and the other wire under one of the side pinchers. Either polarity of the probe can be tested and will yield the same results (but opposite phase) if the probe is working properly. **Figure 63** shows a close up of the tip wires positioned under the pinchers.
- d Ideally the probe head should not be angled toward the port 2 side of the PV fixture, but a slight angle of 5 degrees is acceptable. If angled too much, the measured BW of the probe will be degraded due to coupling from the trace to the probe tip.

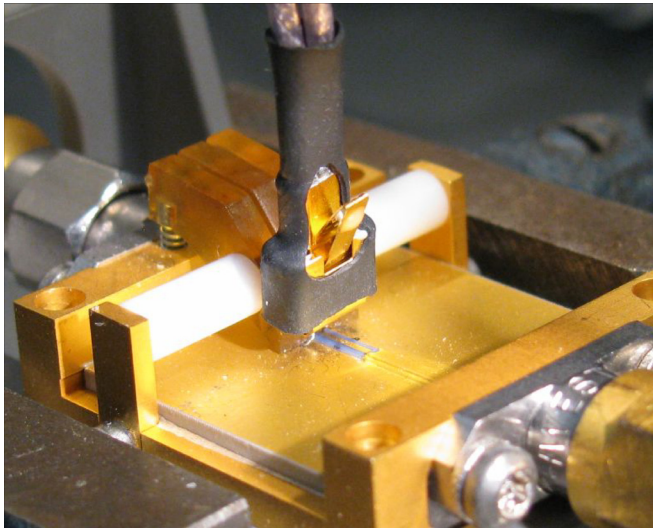

Figure 63 Close-up of tip wires positioned under pinchers

- 7 Install the proper file to de-embed the 1250-1749 adapter and the output side of the N5443A (i.e. the path from the male 2.92 mm connector to the probe point of the N5443A) from port 1 of the VNA.
 - a Create a Touchstone file for the 1250-1749 and N5443A PV fixture by cutting and pasting the text in **“Touchstone File (1250-1749 & N5443A)”** on page 94. Name the file **Adaptor_1250_1749__OutputSideOfFixture_N5443A.s2p**.
 - b On the VNA, go to menu “Calibration/Fixturing Selections/2 Port De-embedding” and select Port 1.
 - c Set S2P file selection to the file saved in step a.
 - d Check the “Enable De-embedding”.
 - e Under “Calibration” menu, select “Fixturing ON/off” to turn on de-embedding.
- 8 Trigger VNA to perform a single sweep. a. Press “Trigger” under Channel Setup, and then the green soft-key for “Single”. Display should look like **Figure 64**. If it looks noticeably different, the probe tip wires may not be making contact under the pinchers.

- 9 Under “Trace/Math/Memory” select “Data->Memory”. This will save the de-embedded input voltage trace into the memory.



Figure 64 De-embedded “Vin” trace

- 10 Now move the 2.92 mm male test port 1 connector to the 5062_1247 adapter and N5477A Autoprobe II adapter assembly. Connect the Maury Microwave 8775B2 2.92 mm male broadband load to the 1250_1749 adaptor and N5443A PV fixture assembly. This new setup is shown in **Figure 65**. Torque all connections.
- 11 Install the proper file to de-embed the 5062_1247 adapter and N5477A adapter from port 1 of the VNA.
- Create a Touchstone file for the 5062-1247 and N5477A by cutting and pasting the text in **“Touchstone File (5062-1247 & N5477A)”** on page 98. Name the file **Adapter_5062_1247__Adapter_N5477A.s2p**.
 - Go to menu “Calibration/Fixturing Selections/2 Port De-embedding” and select Port 1.
 - Set S2P file selection to the file saved in step a.
 - Make sure the “Enable De-embedding” box is still checked.
 - Under “Calibration” menu, make sure “Fixturing ON/off” is still checked so file is being used for de-embedding.

- 12 Trigger VNA to perform a single sweep.
 - a Press “Trigger” under Channel Setup, and then the green soft-key for “Single”.
 - b Under “Scale” menu, adjust the reference level until the 50 MHz point (left side of the screen) is at center screen. Reference level should be approximately -15.3 dB, but can vary a few tenths of a dB either way.
 - c Display should look like **Figure 66**. If it looks noticeably different, the probe tip wires may not be making contact under the pinchers.

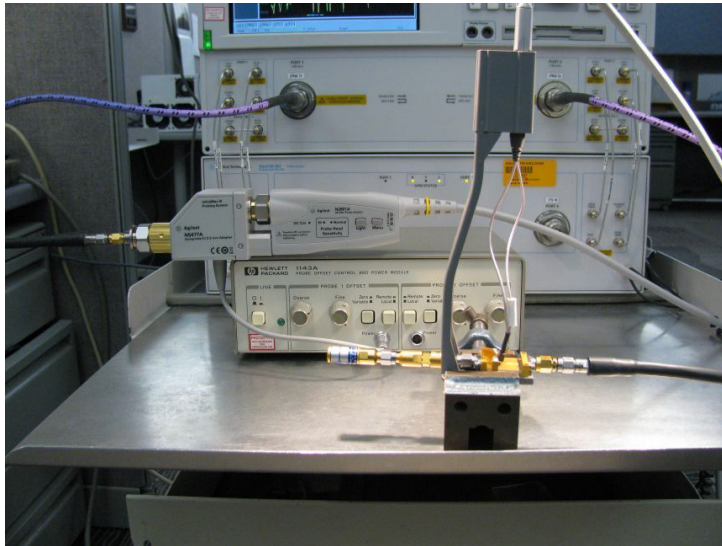

Figure 65 Setup to measure “Vout” of probe

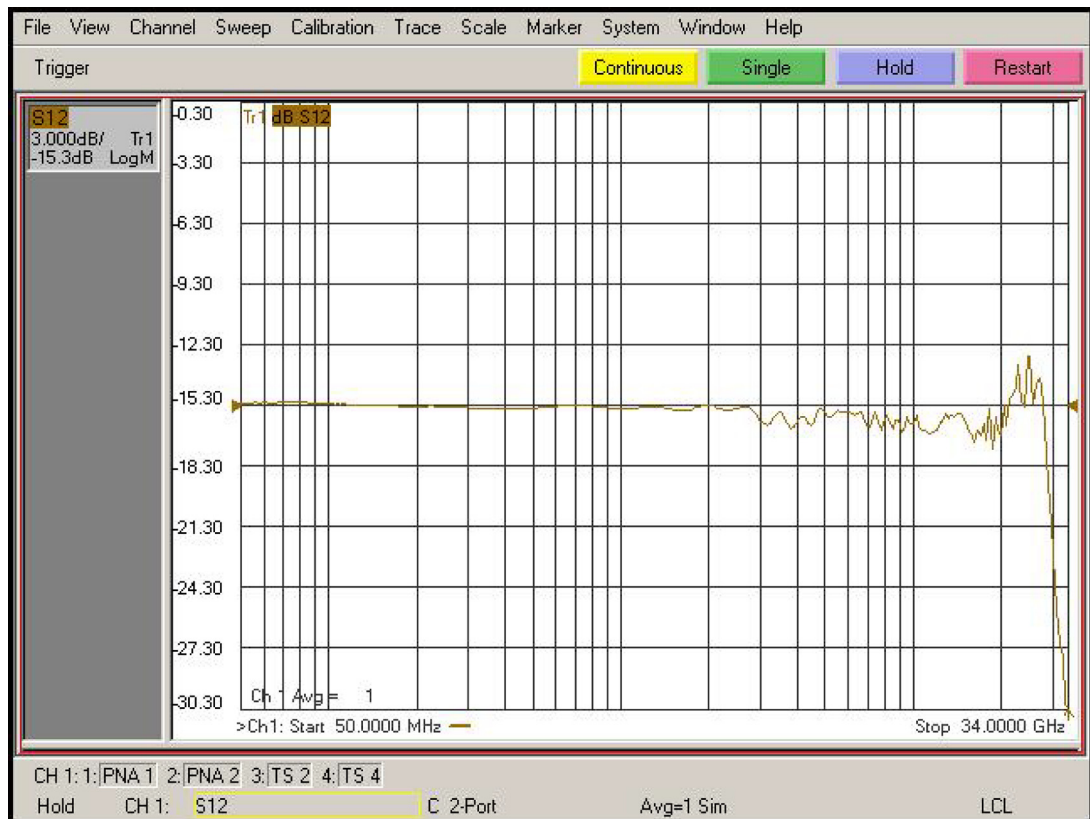

Figure 66 De-embedded "Vout" trace

- 13 Under menu "Trace/Math/Memory" select "Data/Memory" in the "Data Math" box.
 - a This will divide the current trace (de-embedded vout trace) by the memory trace (de-embedded vin trace) and therefore show the voltage transfer function of the probe or "vout/vin".
 - b Again, adjust the "Reference Level" in the scale menu so the 50MHz point is at center screen. The display should look like **Figure 67**.
 - c Turn on a marker and adjust it to where the trace crosses 3 dB below the 50 MHz point (which is 1 division below center screen since screen is set to 3 dB/div).
 - d Verify that the BW is ≥ 26 GHz for the N5440A ceramic ZIF tip, N5439A ZIF probe head, and N2803A 30 GHz probe amp combination.

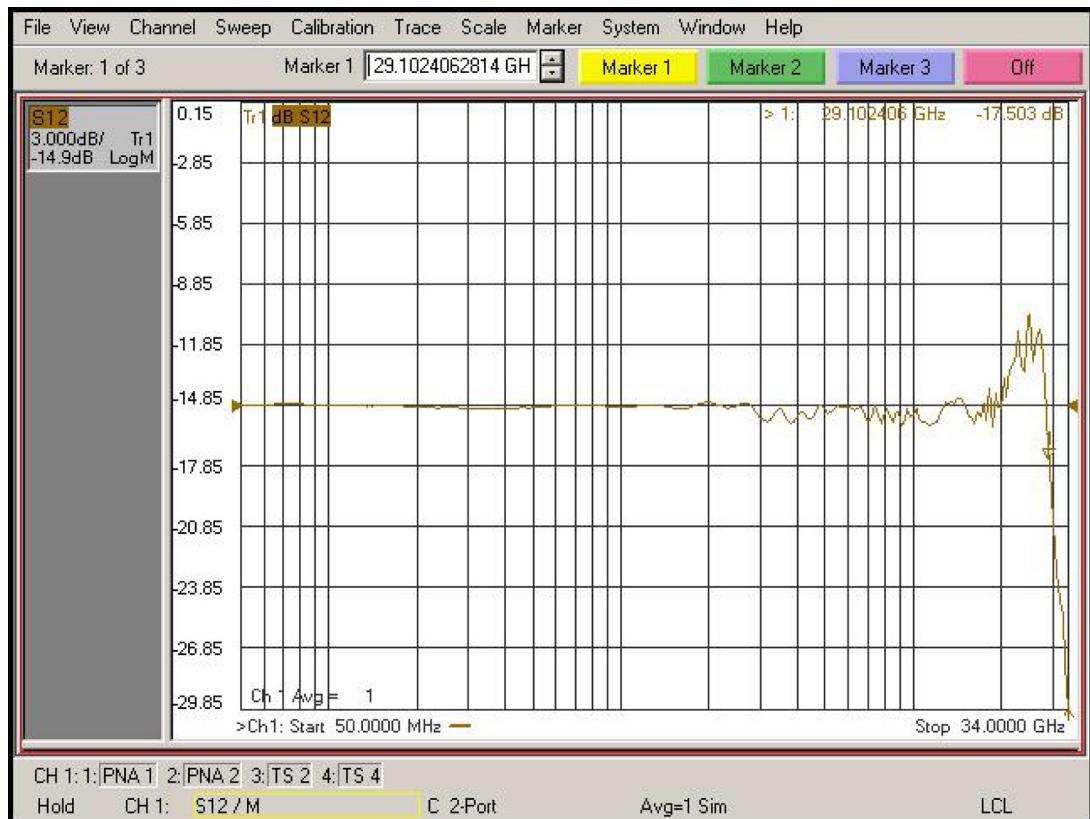

Figure 67 De-embedded “Vout/Vin” response of the probe

NOTE

You only need to perform the Bandwidth Performance Verification test with the ZIF tip as described above. If the probe passes with the ZIF probe head then it will pass with the browser probe head as well. You are not required to test the bandwidth specification with both probe heads. If you have the choice between using the ZIF probe head or the browser, Keysight suggests using the ZIF probe head because measurements are more repeatable with it and it is easier to make a proper connection.

To measure the performance of the N5445A Browser with the N2803A probe amp, the same procedure as described above is used except the browser is held in position with a probe positioner. This setup is shown in [Figure 69](#) and [Figure 69](#) using the Keysight N2787A 3D Probe Positioner.

- 1 Tilt the browser slightly so the two tips touch the center trace and the ground plane on the PV fixture at about the same time.
- 2 Probe the halfway point between the where the pinchers are and where the microstrip transitions into the rectangular coax line.
- 3 Set the span of the browser to the minimum possible as should in this picture:

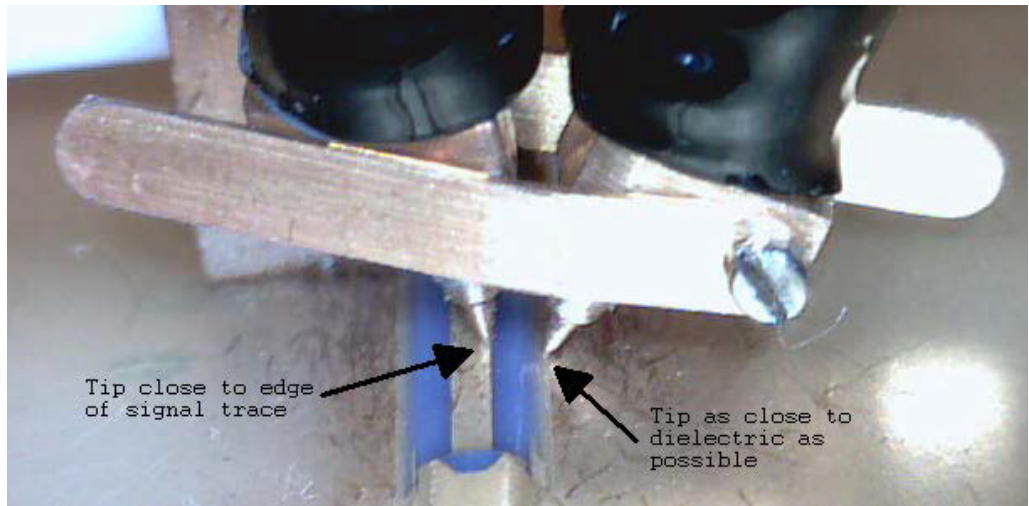

Figure 68 Probe Tips on Microstrip

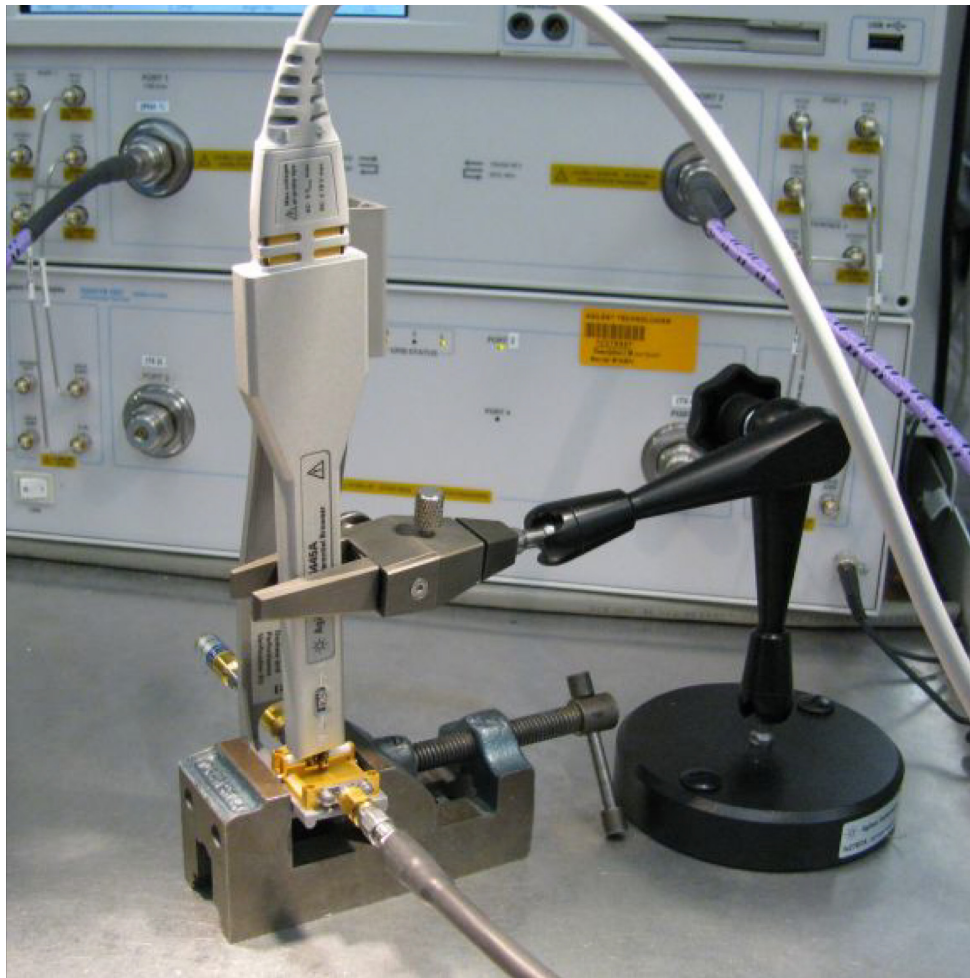

Figure 69 N2787A 3D Probe Positioner used to measure the N5445A browser with the N2803A amp

Touchstone File (1250-1749 & N5443A)

Cut and paste the following text and save in a text file named **Adapter_1250_1749__OutputSideOfFixture_N5443A.s2p**. This file is used in **Step 7** on page 87.

NOTE

You'll also find the following data on the Adobe AIR version of the Probe Resource Center (PRC). Copying this data from the PRC is the simplest most reliable method to get the data. To download the PRC, visit <http://www.Keysight.com/find/PRC>.

```
! freq S11 S21 S12 S22
!Port 1=female 3.5mm connector of 1250-1749 adaptor, Port 2=probe point on N5443A fixture
# Hz S DB R 50
50000000.000000 -49.528411 110.869328 -0.026318 -4.180881 -0.025870 -4.223772 -67.754661 -176.153454
51165694.067857 -49.988587 91.181375 -0.025517 -4.280433 -0.024720 -4.324675 -68.880923 -164.662475
52358564.988911 -50.522661 71.165730 -0.024697 -4.382306 -0.023543 -4.427929 -70.190588 -152.193533
53579246.361093 -51.148132 50.755093 -0.023858 -4.486555 -0.022339 -4.533591 -71.710672 -138.296498
54828386.553961 -51.883012 29.852775 -0.023000 -4.593234 -0.021107 -4.641716 -73.455393 -122.229302
56106649.053084 -52.745137 8.328609 -0.022122 -4.702400 -0.019846 -4.752362 -75.383422 -102.800368
57414712.812455 -53.751090 -13.985221 -0.021223 -4.814111 -0.018557 -4.865588 -77.285484 -78.453735
58753272.615119 -54.914477 -37.296089 -0.020304 -4.928426 -0.017237 -4.981454 -78.641246 -48.710849
60123039.442212 -56.136285 -60.059373 -0.019410 -5.044783 -0.015920 -5.098670 -78.505514 -17.996645
61524740.850598 -56.339746 -65.253403 -0.018972 -5.157375 -0.014907 -5.204612 -74.600997 0.238726
62959121.359318 -56.549712 -70.614809 -0.018523 -5.272593 -0.013871 -5.313024 -71.786638 16.619539
64426942.845040 -56.765722 -76.151300 -0.018064 -5.390497 -0.012811 -5.423964 -69.665881 32.555062
65928984.946733 -56.987159 -81.870529 -0.017595 -5.511150 -0.011726 -5.537491 -68.056466 48.587163
67466045.479778 -57.213226 -87.779882 -0.017115 -5.634616 -0.010616 -5.653665 -66.866526 65.023732
69038940.859729 -57.442930 -93.886209 -0.016623 -5.760962 -0.009481 -5.772548 -66.050126 82.119449
70648506.535956 -57.624590 -110.396155 -0.016195 -5.894832 -0.009445 -5.897344 -64.822182 90.200098
72295597.435395 -57.551220 -142.499775 -0.015869 -6.038769 -0.011116 -6.029813 -62.891316 82.809542
73981088.416647 -57.272309 -174.184620 -0.015537 -6.186061 -0.012827 -6.165369 -61.314332 74.543748
75705874.734666 -56.913609 155.103108 -0.015196 -6.336786 -0.014577 -6.304085 -59.987656 65.638030
77470872.516269 -56.615036 125.361237 -0.014847 -6.491025 -0.016368 -6.446035 -58.847549 56.200571
79277019.246748 -56.489319 96.190629 -0.014491 -6.648860 -0.018202 -6.591294 -57.851655 46.281987
81125274.267814 -56.086810 77.082571 -0.015125 -6.803245 -0.019025 -6.749358 -57.369635 49.668006
83016619.287160 -55.464039 64.084902 -0.016432 -6.956544 -0.019176 -6.917300 -57.199270 61.953448
84952058.899892 -54.917900 50.564549 -0.017770 -7.113416 -0.019329 -7.089158 -57.075871 74.341353
86932621.122130 -54.439335 36.470021 -0.019138 -7.273947 -0.019487 -7.265023 -57.007441 86.897368
88959357.937037 -54.018288 21.746324 -0.020539 -7.438220 -0.019648 -7.444988 -57.001200 99.698955
91033345.853589 -54.097863 14.550734 -0.021520 -7.608109 -0.020285 -7.619545 -56.504223 102.747003
93155686.478363 -54.688270 15.600999 -0.022057 -7.783797 -0.021424 -7.788273 -55.536632 95.350174
95327507.100664 -55.335875 16.745463 -0.022606 -7.963581 -0.022589 -7.960934 -54.662417 87.625100
97549961.291281 -56.051127 18.000772 -0.023168 -8.147556 -0.023782 -8.137620 -53.867407 79.587653
99824229.515220 -56.847547 19.421327 -0.023744 -8.335819 -0.025002 -8.318424 -53.140655 71.244030
102151519.758706 -57.028409 32.229328 -0.024811 -8.518103 -0.025270 -8.526257 -53.229937 71.824660
104533068.170813 -57.203696 45.767193 -0.025943 -8.703769 -0.025461 -8.740842 -53.390484 73.175172
106970139.720046 -57.452641 59.100435 -0.027102 -8.893763 -0.025657 -8.960430 -53.558351 74.544470
109464028.866236 -57.799354 72.247228 -0.028288 -9.088187 -0.025857 -9.185138 -53.734081 75.931667
112016060.248099 -58.100099 86.407713 -0.028945 -9.298506 -0.026957 -9.388528 -53.893471 77.124371
114627589.386818 -58.637120 78.159701 -0.029466 -9.516820 -0.028326 -9.589435 -54.061522 66.848820
117300003.406038 -59.105065 79.877381 -0.029999 -9.740223 -0.029727 -9.795026 -54.247548 61.492888
120034721.768639 -59.584054 81.490201 -0.030537 -9.968856 -0.031146 -10.005562 -54.448452 56.117498
122833197.030691 -57.847096 78.713336 -0.030505 -10.204469 -0.031384 -10.233007 -54.242926 55.717121
125696915.612984 -56.373050 75.635986 -0.030472 -10.445575 -0.031627 -10.465755 -54.037670 55.307462
128627398.590544 -55.090007 72.338796 -0.030439 -10.692303 -0.031876 -10.703929 -53.832682 54.888298
131626202.500562 -54.306379 66.932129 -0.030205 -10.948451 -0.031570 -10.953764 -53.494817 54.988088
134694920.169152 -53.880297 59.647516 -0.029793 -11.213741 -0.030773 -11.214700 -53.052945 55.558900
137835181.557386 -53.486272 52.104536 -0.029372 -11.485216 -0.029957 -11.481720 -52.622790 56.157336
141048654.627056 -53.508282 45.730461 -0.030159 -11.752986 -0.030107 -11.751715 -52.284361 56.421252
144337046.226616 -54.420700 42.364200 -0.033536 -12.005802 -0.032342 -12.021139 -52.117964 55.931890
147702102.997784 -55.470568 39.211352 -0.036994 -12.264512 -0.034630 -12.296845 -51.951089 55.430858
151145612.303275 -55.576811 37.842963 -0.039670 -12.539287 -0.036049 -12.583748 -51.944456 54.446241
154669403.176167 -53.732676 40.105390 -0.040639 -12.841065 -0.035607 -12.887130 -52.278075 52.497820
158275347.291397 -52.178102 42.969822 -0.041630 -13.149878 -0.035156 -13.197584 -52.635093 50.550437
161965359.959910 -52.004259 45.986266 -0.041770 -13.470541 -0.034641 -13.513759 -52.766109 50.989381
165741401.145982 -53.013032 48.920340 -0.041128 -13.802856 -0.034066 -13.835944 -52.680124 53.568723
169605476.508267 -54.185614 51.938022 -0.040471 -14.142918 -0.033479 -14.165639 -52.594837 56.183902
173559638.465103 -53.353535 46.144495 -0.039591 -14.466058 -0.034106 -14.495652 -52.681223 53.054380
177605987.284668 -52.395549 39.070167 -0.038666 -14.793912 -0.034887 -14.832523 -52.797494 49.218907
181746672.200541 -52.169589 35.688968 -0.038595 -15.133923 -0.035919 -15.178503 -53.030384 48.315967
185983892.553281 -52.903697 37.808367 -0.039749 -15.488188 -0.037303 -15.534312 -53.432713 51.562899
190319898.958608 -53.671016 40.107673 -0.040862 -15.851057 -0.038670 -15.897833 -53.787995 54.424805
194756994.502833 -53.801795 43.465778 -0.041123 -16.226810 -0.039438 -16.262335 -53.156799 52.243875
199297535.966146 -53.943086 46.823120 -0.041390 -16.611323 -0.040225 -16.635334 -52.557852 50.013514
```

7428374655.799140 -27.017620 -164.842451 -0.348642 104.090333 -0.350091 104.061237 -28.919257 -172.662528
7601558901.200872 -28.551834 174.443449 -0.347845 89.718285 -0.349058 89.706641 -31.030126 -178.119157
7778780743.552826 -29.482132 148.355026 -0.349523 75.016467 -0.358008 74.972608 -32.590336 -177.895400
7960134314.911269 -30.871044 118.843742 -0.356179 59.960289 -0.356072 59.945644 -33.687188 -170.658171
8145715941.916058 -31.950742 79.399064 -0.362965 44.538332 -0.361544 44.536516 -33.634250 -156.266570
8335624196.954902 -31.102992 41.941266 -0.368766 28.807538 -0.367519 28.749027 -31.418216 -149.846807
8529959950.520464 -29.506952 12.987833 -0.380587 12.700933 -0.371898 12.632583 -29.617847 -154.917241
8728826424.788105 -28.037976 -11.924768 -0.387358 -3.772489 -0.377158 -3.828796 -28.033121 -165.368743
8932329248.442736 -27.178655 -33.429976 -0.393930 -20.622293 -0.387888 -20.700028 -27.140427 -179.247325
9140576512.783896 -26.590219 -54.325530 -0.400342 -37.878546 -0.397504 -37.929492 -26.794476 164.982238
9353678829.138855 -26.410378 -73.335178 -0.407440 -55.528809 -0.401149 -55.588250 -26.749329 147.729718
9571749387.614246 -26.714829 -88.237234 -0.410414 -73.575672 -0.405640 -73.594043 -27.471766 127.264105
9794904017.217421 -27.784409 -102.254518 -0.413424 -92.036107 -0.405178 -92.065913 -29.288726 106.168277
10023261247.379461 -29.946849 -113.393625 -0.415196 -110.952968 -0.410031 -111.004263 -32.941982 80.431768
10256942370.912546 -33.467963 -111.933273 -0.416094 -130.366719 -0.415555 -130.393886 -39.546464 35.419669
10496071508.435085 -35.844062 -83.069634 -0.425423 -150.213792 -0.418926 -150.256785 -39.552620 -88.456959
10740775674.298862 -31.594934 -55.582996 -0.430726 -170.525020 -0.427623 -170.564105 -31.250912 -133.959009
10991184844.053186 -27.345484 -58.704648 -0.440006 168.685369 -0.439718 168.630262 -26.639771 -161.126596
11247432023.481905 -24.270939 -69.126451 -0.456322 147.439024 -0.449060 147.371764 -23.920976 172.437459
11509653319.249928 -22.222011 -85.685044 -0.470606 125.714476 -0.464162 125.646750 -21.899028 147.100182
11777988011.196802 -20.892091 -104.819406 -0.485741 103.505487 -0.482557 103.398888 -20.621755 123.860148
12052578626.315733 -19.912105 -123.956104 -0.503675 80.788596 -0.495872 80.740772 -19.692077 98.664504
12333571014.457333 -19.497816 -147.212200 -0.508376 57.572177 -0.509731 57.482576 -19.471600 76.401941
12621114425.798326 -19.543071 -170.672396 -0.512781 33.789680 -0.504274 33.733344 -19.628177 53.134740
12915361590.116354 -19.992728 160.959326 -0.511246 9.447349 -0.501680 9.367454 -20.266146 34.221120
13216468797.912968 -20.711590 126.547146 -0.502591 -15.541526 -0.499251 -15.576244 -21.010230 19.709050
13524595983.427933 -21.426162 84.306572 -0.510405 -41.123231 -0.509740 -41.200330 -21.466613 12.415942
13839906809.588905 -20.960271 35.922011 -0.519346 -67.368700 -0.517751 -67.434663 -21.004955 7.109877
14162568754.941620 -19.386936 -9.482291 -0.546208 -94.193857 -0.538859 -94.244322 -19.279569 -1.526207
14492753202.606752 -17.607733 -48.883689 -0.578799 -121.606363 -0.569568 -121.658188 -17.509474 -16.111468
14830635531.310724 -16.058479 -85.299362 -0.618100 -149.484635 -0.618535 -149.541717 -16.084639 -35.440127
15176395208.538778 -15.236915 -119.431135 -0.647631 -177.960047 -0.644491 -178.030288 -15.352338 -57.340933
15530215885.859812 -15.065709 -154.592735 -0.660264 153.014482 -0.658133 153.003053 -15.173200 -80.159018
15892285496.473612 -15.566862 168.702105 -0.644811 123.213682 -0.635579 123.149684 -15.854211 -100.792741
16262796355.032291 -17.185189 128.943209 -0.612713 92.711057 -0.605704 92.642379 -17.351408 -121.539091
16641945259.788942 -19.517598 79.609952 -0.586104 61.195419 -0.579928 61.155659 -19.345649 -133.056375
17029933597.127781 -22.052969 14.417418 -0.567689 28.875945 -0.564626 28.806397 -21.149985 -133.824999
17426967448.531292 -21.630443 -59.992319 -0.583576 -4.158770 -0.574743 -4.255992 -20.911414 -131.946593
17833257700.041199 -19.673154 -120.894595 -0.601843 -37.884863 -0.593646 -37.981253 -19.659181 -138.614133
18249020154.271370 -18.806881 -174.276372 -0.618695 -72.289682 -0.609299 -72.420566 -18.994739 -153.494312
18674475645.032219 -19.178945 134.206183 -0.619021 -107.527664 -0.614326 -107.586015 -19.447309 -168.513398
19109850154.627415 -19.950051 73.371028 -0.618376 -143.565386 -0.611954 -143.651099 -20.065279 179.863710
19555374933.885239 -20.409308 7.727679 -0.619886 179.407608 -0.622828 179.396896 -20.470586 169.575271
20011286624.988346 -19.579681 -58.016432 -0.626351 141.642169 -0.628446 141.549209 -20.272460 158.551078
20477827387.167168 -19.235856 -115.281184 -0.639397 102.910502 -0.637766 102.864098 -20.495114 142.323830
20955245025.323700 -20.044807 -172.267159 -0.636528 63.319590 -0.622112 63.277382 -21.696936 125.790595
21443793121.654022 -21.683487 128.397837 -0.638893 22.760432 -0.630205 22.758924 -22.470371 115.132339
21943731170.339451 -23.474823 60.110496 -0.639381 -18.730062 -0.644866 -18.828618 -22.521536 100.916605
22455324715.377853 -25.165813 -9.497241 -0.659748 -61.201745 -0.649063 -61.248669 -22.485450 79.355738
22978845491.628361 -27.550912 -68.306165 -0.654315 -104.664654 -0.654273 -104.699819 -24.370615 45.962002
23514571569.144375 -38.154103 -108.867665 -0.659796 -149.285435 -0.654825 -149.301469 -32.362011 14.707828
24062787500.871529 -26.705129 3.489938 -0.664487 164.941804 -0.673097 164.975383 -29.551453 127.286232
24623784473.789066 -19.960691 -37.343281 -0.709519 118.324966 -0.711951 118.268423 -20.876395 83.706187
25197860463.574921 -17.075968 -82.581482 -0.762437 70.800631 -0.752851 70.658498 -17.644528 33.508342
25785320392.876629 -16.389933 -129.665074 -0.773976 22.251711 -0.785924 22.378393 -17.091366 -14.641963
26386476293.272152 -17.740325 170.336058 -0.751568 -27.464393 -0.745351 -27.641774 -19.396216 -54.587976
27001647471.006645 -20.441710 86.953452 -0.707798 -78.927817 -0.688728 -78.963080 -22.786124 -65.976014
27631160676.593178 -18.708938 -4.202202 -0.758800 -131.434860 -0.766884 -131.560447 -19.566558 -71.685007
28275350278.367512 -16.258572 -68.478347 -0.826408 175.068642 -0.822329 175.113490 -17.059431 -116.230704
28934558440.089119 -17.148103 -113.353816 -0.822544 120.550907 -0.825989 120.585659 -18.527425 177.493812
29609135302.682766 -19.586442 -134.578145 -0.785243 64.443280 -0.793101 64.316744 -22.070782 76.512077
30299439170.217197 -17.742592 -148.982049 -0.825947 6.809963 -0.812757 6.969945 -18.819692 -28.285789
31005836700.219704 -16.903313 155.292062 -0.824193 -51.457599 -0.858126 -51.738834 -17.800752 -87.794210
31728703098.427670 -18.748424 57.068278 -0.801196 -112.022259 -0.836282 -112.293270 -20.219688 -105.626698
32468422318.080524 -14.659329 -55.335061 -0.919360 -174.054710 -0.905470 -174.339069 -15.122997 -111.544467
33225387263.857967 -11.577429 -135.909942 -1.104865 123.781065 -1.105881 123.849957 -12.199337 -156.048844
34000000000.000000 -13.297830 149.794119 -1.023492 60.693197 -1.035722 60.797201 -13.786461 155.311288

Touchstone File (5062-1247 & N5477A)

Cut and paste the following text and save in a text file named **Adapter_5062_1247__Adapter_N5477A.s2p**. This file is used in **Step 11** on page 88.

NOTE

You'll also find the following data on the Adobe AIR version of the Probe Resource Center (PRC). Copying this data from the PRC is the simplest most reliable method to get the data. To download the PRC, visit <http://www.keysight.com/find/PRC>.

```
! freq S11 S21 S12 S22
!Port 1=female side of 5062_1247 adaptor, Port 2=male side of N5477A
# Hz S DB R 50
50000000.000000 -41.543761 18.199382 -0.015231 -10.158056 -0.028545 -10.064176 -41.019132 74.184681
51165694.067857 -41.582558 18.207470 -0.015602 -10.384282 -0.028789 -10.293624 -41.089383 73.495272
52358564.988911 -41.622441 18.215746 -0.015982 -10.615782 -0.029040 -10.528422 -41.161865 72.789791
53579246.361093 -41.663443 18.224215 -0.016371 -10.852680 -0.029296 -10.768693 -41.236668 72.067861
54828386.553961 -41.705603 18.232881 -0.016769 -11.095100 -0.029558 -11.014566 -41.313888 71.329101
56106649.053084 -41.748959 18.241750 -0.017177 -11.343172 -0.029827 -11.266171 -41.393626 70.573118
57414712.812455 -41.793551 18.250825 -0.017593 -11.597028 -0.030101 -11.523642 -41.475987 69.799509
58753272.615119 -41.839421 18.260112 -0.018020 -11.856802 -0.030382 -11.787116 -41.561085 69.007865
60123039.442212 -41.886612 18.269615 -0.018457 -12.122633 -0.030670 -12.056732 -41.649039 68.197764
61524740.850598 -41.935170 18.279340 -0.018903 -12.394661 -0.030964 -12.332635 -41.739975 67.368777
62959121.359318 -41.985143 18.289291 -0.019360 -12.673031 -0.031266 -12.614969 -41.834027 66.520463
64426942.845040 -42.036581 18.299475 -0.019828 -12.957891 -0.031574 -12.903886 -41.931338 65.652372
65928984.946733 -42.089534 18.309896 -0.020307 -13.249392 -0.031889 -13.199539 -42.032060 64.764041
67466045.479778 -42.144059 18.320560 -0.020797 -13.547689 -0.032212 -13.502084 -42.136353 63.855001
69038940.859729 -42.200212 18.331472 -0.021298 -13.852941 -0.032543 -13.811683 -42.244390 62.924767
70648506.535956 -42.258052 18.342639 -0.021812 -14.165309 -0.032881 -14.128500 -42.356354 61.972846
72295597.435395 -42.317642 18.354067 -0.022337 -14.484960 -0.033227 -14.452703 -42.472443 60.998732
73981088.416647 -42.379047 18.365760 -0.022874 -14.812063 -0.033581 -14.784464 -42.592867 60.001907
75705874.734666 -42.442337 18.377727 -0.023424 -15.146792 -0.033943 -15.123961 -42.717851 58.981843
77470872.516269 -42.507583 18.389972 -0.023987 -15.489325 -0.034314 -15.471372 -42.847639 57.937997
79277019.246748 -42.574861 18.402503 -0.024563 -15.839843 -0.034693 -15.826886 -42.982492 56.869814
81125274.267814 -42.644252 18.415326 -0.025152 -16.198534 -0.035081 -16.190681 -43.122690 55.776729
83016619.287160 -42.715839 18.428448 -0.025756 -16.565587 -0.035479 -16.562962 -43.268539 54.658159
84952058.899892 -42.789711 18.441876 -0.026373 -16.941198 -0.035885 -16.943922 -43.420368 53.513511
86932621.122130 -42.865962 18.455617 -0.027005 -17.325565 -0.036302 -17.333763 -43.578533 52.342177
88959357.937037 -42.944689 18.469678 -0.027651 -17.718894 -0.036728 -17.732694 -43.743424 51.143535
91033345.853589 -43.025998 18.484067 -0.028313 -18.121392 -0.037163 -18.140925 -43.915463 49.916947
93155686.478363 -43.109997 18.498792 -0.028990 -18.533275 -0.037609 -18.558673 -44.095114 48.661763
95327507.100664 -43.196804 18.513859 -0.029683 -18.954760 -0.038066 -18.986161 -44.282882 47.377316
97549961.291281 -43.286543 18.529278 -0.030393 -19.386071 -0.038533 -19.423615 -44.479324 46.062923
99824229.515220 -43.379343 18.545057 -0.031118 -19.827438 -0.039011 -19.871267 -44.685054 44.717887
102151519.758706 -43.358365 17.974030 -0.031578 -20.282679 -0.039226 -20.325455 -44.681916 43.920698
104533068.170813 -43.327264 17.340603 -0.032024 -20.748832 -0.039422 -20.789906 -44.660665 43.153346
106970139.720046 -43.295554 16.692408 -0.032481 -21.225854 -0.039624 -21.265185 -44.638973 42.368103
109464028.866236 -43.263224 16.029101 -0.032948 -21.713996 -0.039830 -21.751544 -44.616830 41.564553
112016060.248099 -43.232024 15.350329 -0.033426 -22.213520 -0.040040 -22.249242 -44.594230 40.742270
114627589.386818 -43.196665 14.655733 -0.033916 -22.724689 -0.040256 -22.758544 -44.571163 39.900816
117300003.406038 -43.162416 13.944943 -0.034416 -23.247775 -0.040477 -23.279719 -44.547622 39.039744
120034721.768639 -43.127508 13.217582 -0.034929 -23.783057 -0.040703 -23.813045 -44.523598 38.158598
122833197.030691 -43.091931 12.473263 -0.035454 -24.330818 -0.040934 -24.358805 -44.499082 37.256908
125696915.612984 -43.055765 11.711592 -0.035990 -24.891349 -0.041170 -24.917289 -44.474067 36.334197
128627398.590544 -43.018729 10.932162 -0.036540 -25.464949 -0.041413 -25.488793 -44.448542 35.389973
131626202.500562 -42.981085 10.134562 -0.037102 -26.051921 -0.041660 -26.073621 -44.422500 34.423737
134694920.169152 -42.942730 9.318366 -0.037677 -26.652579 -0.041914 -26.672084 -44.395931 33.434973
137835181.557386 -42.903656 8.483141 -0.038266 -27.267239 -0.042173 -27.284499 -44.368827 32.423157
141048654.627056 -42.863852 7.628444 -0.038869 -27.896230 -0.042439 -27.911192 -44.341178 31.387752
144337046.226616 -42.823309 6.753821 -0.039486 -28.539885 -0.042711 -28.552495 -44.312975 30.328208
147702102.997784 -42.782014 5.858807 -0.040117 -29.198546 -0.042989 -29.208750 -44.284210 29.243962
151145612.303275 -42.761443 4.946541 -0.040680 -29.873082 -0.043283 -29.881319 -44.250154 28.088307
154669403.176167 -42.784598 4.020426 -0.041087 -30.564410 -0.043606 -30.571648 -44.205805 26.811021
158275347.291397 -42.808357 3.072719 -0.041503 -31.271854 -0.043936 -31.278072 -44.160655 25.503957
161965359.959910 -42.832738 2.102918 -0.041930 -31.995792 -0.044274 -32.000965 -44.114694 24.166420
165741401.145982 -42.857758 1.110506 -0.042366 -32.736608 -0.044619 -32.740712 -44.067912 22.797700
169605476.508267 -42.883436 0.094958 -0.042812 -33.494695 -0.044973 -33.497705 -44.020299 21.397070
173559638.465103 -42.909791 -0.944266 -0.043269 -34.270456 -0.045335 -34.272347 -43.971845 19.963785
177605987.284668 -42.936844 -2.007719 -0.043736 -35.064303 -0.045706 -35.065048 -43.922539 18.497086
181746672.200541 -42.964615 -3.095965 -0.044215 -35.876657 -0.046085 -35.876231 -43.872372 16.996191
185983892.553281 -42.993126 -4.209583 -0.044704 -36.707951 -0.046473 -36.706325 -43.821333 15.460305
190319898.958608 -43.022399 -5.349163 -0.045205 -37.558626 -0.046870 -37.555772 -43.769413 13.888612
194756994.502833 -43.052457 -6.515311 -0.045718 -38.429133 -0.047276 -38.425023 -43.716602 12.280276
199297535.966146 -43.083324 -7.708646 -0.046242 -39.319934 -0.047692 -39.314540 -43.662891 10.634444
```

7428374655.799140 -37.293649 14.340553 -0.263882 -14.759133 -0.258908 -14.695756 -32.761639 143.058679
 7601558901.200872 -36.907940 3.855324 -0.267100 -48.660334 -0.266499 -48.613209 -33.766269 86.068082
 7778780743.552826 -35.828061 -13.657090 -0.271380 -83.387048 -0.266894 -83.289164 -33.270815 21.805711
 7960134314.911269 -33.493068 -37.569054 -0.271134 -118.872118 -0.273741 -118.805162 -31.780351 -32.970164
 8145715941.916058 -32.118290 -70.028402 -0.275567 -155.198803 -0.273571 -155.161065 -30.962180 -79.289275
 8335624196.954902 -31.894002 -107.235305 -0.277590 167.618358 -0.275756 167.679923 -31.479945 -118.300978
 8529959950.520464 -32.709673 -149.757670 -0.279359 129.577007 -0.279958 129.627666 -33.271908 -152.082983
 8728826424.788105 -34.055029 170.816461 -0.278450 90.627878 -0.278118 90.672620 -35.491196 -170.796459
 8932329248.442736 -36.258756 128.748237 -0.282665 50.786153 -0.283395 50.827135 -35.932918 176.041429
 9140576512.783896 -36.732617 92.598448 -0.285237 9.972934 -0.285945 10.039086 -34.847845 146.764188
 9353678829.138855 -36.232488 61.014514 -0.289335 -31.720162 -0.289564 -31.670633 -34.307010 92.427431
 9571749387.614246 -35.087275 25.123510 -0.293625 -74.424410 -0.293981 -74.329573 -34.448660 29.777906
 9794904017.217421 -35.866841 -16.830593 -0.297243 -118.070354 -0.295732 -118.017380 -34.561003 -43.260195
 10023261247.379461 -40.371336 -58.565056 -0.299652 -162.808725 -0.298000 -162.714229 -35.356462 -128.009378
 10256942370.912546 -47.858119 8.883051 -0.301757 151.432559 -0.301873 151.505185 -34.497053 135.597672
 10496071508.435085 -36.622941 4.554259 -0.307021 104.591699 -0.306216 104.665149 -31.849678 54.509330
 10740775674.298862 -32.971346 -43.725031 -0.310831 56.700025 -0.310562 56.745140 -31.110504 -17.560468
 10991184844.053186 -34.021301 -98.567108 -0.311071 7.658483 -0.313540 7.726542 -33.136970 -86.070846
 11247432023.481905 -39.998388 -168.509597 -0.310230 -42.516342 -0.312171 -42.442511 -41.798286 171.688717
 11509653319.249928 -50.076241 -3.651648 -0.317472 -93.894268 -0.319884 -93.812161 -36.457406 31.607998
 11777988011.196802 -39.760612 -111.165462 -0.320336 -146.478896 -0.319876 -146.401224 -34.479967 -29.533247
 12052578626.315733 -34.421795 142.154319 -0.322845 159.728999 -0.321560 159.765128 -39.573202 -22.198166
 12333571014.457333 -28.527502 57.480125 -0.331446 104.628713 -0.331240 104.726450 -29.076002 -13.943374
 12621114425.798326 -25.458389 -15.363700 -0.345952 48.348568 -0.344764 48.406678 -24.185101 -64.550120
 12915361590.116354 -25.537326 -84.720027 -0.350982 -9.171222 -0.350894 -9.126921 -23.914883 -122.687993
 13216468797.912968 -29.497841 -161.321749 -0.341054 -68.157091 -0.337756 -68.086689 -28.496513 175.818802
 13524595983.427933 -37.523983 86.570049 -0.335982 -128.574086 -0.340256 -128.512309 -48.380436 -166.259847
 13839906809.588905 -38.684722 -47.834989 -0.346287 169.594823 -0.339239 169.687215 -32.352399 -154.247275
 14162568754.941620 -45.875328 -112.341572 -0.344358 106.400526 -0.343395 106.422508 -31.414879 112.460071
 14492753202.606752 -38.541178 -66.509388 -0.351636 41.632441 -0.348299 41.699006 -31.751305 -6.751484
 14830635531.310724 -34.024503 -135.325388 -0.356319 -24.549915 -0.359061 -24.467266 -31.213945 -112.794665
 15176395208.538778 -34.741710 147.020941 -0.355504 -92.320829 -0.355349 -92.263858 -34.766455 150.931616
 15530215885.859812 -35.300959 87.230844 -0.357092 -161.686627 -0.354720 -161.661329 -41.363027 107.616521
 15892285496.473612 -30.792606 28.600758 -0.365286 127.262506 -0.357127 127.348334 -30.829188 78.555766
 16262796355.032291 -27.166721 -58.757340 -0.374921 54.662998 -0.370241 54.704425 -24.529908 6.247539
 16641945259.788942 -26.763536 -160.007113 -0.384264 -19.616642 -0.380796 -19.558669 -25.302166 -67.497161
 17029933597.127781 -28.644756 87.146320 -0.372689 -95.667199 -0.369029 -95.638847 -36.512177 -114.107070
 17426967448.531292 -47.848604 -54.576713 -0.375307 -173.611851 -0.371314 -173.536994 -32.117741 -37.192426
 17833257700.041199 -25.373848 77.107861 -0.381565 106.681389 -0.381826 106.752623 -26.695748 -57.166454
 18249020154.271370 -21.671814 -12.233474 -0.399919 25.179522 -0.406146 25.266365 -22.459690 -107.844721
 18674475645.032219 -26.742937 -85.593837 -0.395158 -58.204220 -0.395133 -58.095952 -24.909696 162.854364
 19109850154.627415 -28.414119 -65.676430 -0.397429 -143.696471 -0.389362 -143.605337 -27.890896 -19.577772
 1955374933.885239 -24.586218 -144.108105 -0.414361 128.893776 -0.407288 129.005005 -22.618008 -141.317301
 20011286624.988346 -26.045948 105.213101 -0.402389 39.501393 -0.389836 39.614344 -25.938526 122.482384
 20477827387.167168 -25.898538 12.536934 -0.388736 -52.130474 -0.375999 -52.034114 -30.307011 51.901194
 20955245025.323700 -25.863619 -61.341207 -0.403561 -145.804189 -0.393551 -145.786077 -26.672025 -32.965204
 21443793121.654022 -31.243910 -92.221920 -0.402312 118.118322 -0.396327 118.261313 -31.028754 -177.176860
 21943731170.339451 -23.158869 -12.365828 -0.443013 19.867220 -0.432500 19.917340 -22.801909 8.354422
 22455324715.377853 -20.480757 91.146321 -0.465176 -80.436626 -0.462656 -80.272536 -20.450127 -78.156390
 22978845491.628361 -23.350751 -42.524375 -0.439231 176.888332 -0.437659 176.972824 -24.720232 -132.556294
 23514571569.144375 -29.096385 25.034429 -0.434284 71.509130 -0.415904 71.569311 -29.744440 -88.823584
 24062787500.871529 -20.867025 -106.511416 -0.473044 -36.135123 -0.451251 -36.183006 -20.573606 -144.546395
 24623784473.789066 -26.684148 130.707972 -0.463478 -146.321169 -0.428301 -146.096394 -24.004558 127.818009
 25197860463.574921 -31.160196 61.734789 -0.446323 100.735661 -0.410981 100.913010 -39.408221 -29.991332
 25785320392.876629 -25.533397 -17.272853 -0.440480 -14.729362 -0.438068 -14.647444 -26.709420 161.061882
 26386476293.272152 -22.711245 -101.871135 -0.471170 -133.063592 -0.457863 -133.066616 -23.104139 19.695494
 27001647471.006645 -27.253283 112.297230 -0.461232 106.068363 -0.457380 106.198584 -26.510214 -77.900230
 27631160676.593178 -30.361881 -168.178401 -0.455009 -17.907822 -0.473248 -17.742401 -33.304329 -45.653780
 28275350278.367512 -17.914343 -10.269666 -0.535415 -144.847239 -0.495666 -144.767531 -18.500405 -94.926037
 28934558440.089119 -25.403265 -145.855952 -0.458652 85.819950 -0.471521 86.027882 -25.033409 132.887622
 29609135302.682766 -21.411602 -123.245956 -0.500273 -47.265432 -0.509761 -47.235075 -21.254847 -153.392821
 30299439170.217197 -27.014691 72.673095 -0.489298 176.678655 -0.474972 177.031191 -25.338474 101.072054
 31005836700.219704 -26.316760 -92.472631 -0.452905 37.601195 -0.500821 37.724078 -24.884493 -3.740226
 31728703098.427670 -24.576379 -122.274522 -0.482050 -105.277061 -0.496607 -105.184253 -22.985629 83.341478
 32468422318.080524 -18.473439 97.257414 -0.522336 109.131590 -0.552294 109.178004 -17.832689 -62.528240
 33225387263.857967 -35.956091 36.668777 -0.453368 -40.549604 -0.433040 -40.351388 -38.607656 -59.673550
 34000000000.000000 -18.584633 -83.525655 -0.518071 166.056015 -0.538472 166.289380 -18.908405 -121.618048

DC Input Resistance Performance Verification

Keysight recommends a test interval of one year or 2000 hours of operation.

Table 12 Required Equipment

Type	Requirement
Performance Verification Fixture	Keysight N5443A (no substitute)
BNC(m) to SMA(m) Adapter	Pomona 4288 or equivalent
Banana Plug to BNC(f)	Pomona 1269 or equivalent
Digital Multimeter	Keysight 33401A or equivalent Critical specification: 2 wire resistance accuracy
Power Supply for Probe	DSO/DSA 90000 X-series oscilloscope or 1134A power supply with N5477A Autoprobe adapter (see the procedure " Bandwidth Performance Verification " on page 84.) No substitute
Probe Positioner	Keysight N2787A 3D Probe Positioner Critical specification: stable/accurate positioning
Small Bench Vise	–
InfiniiMax III Probe Head	Either the N5439A ZIF probe head with the N5440A ceramic ZIF tip, the N5441A solder-in probe head, or the N5445A browser probe head. (You only need to perform the Performance Verification test on one of these probe heads, not all of them. If it passes for one of them, then it will pass for all of them.)

Measuring Input Resistance for ZIF Probe Heads or Solder-in Probe Heads

- 1 Connect the BNC to SMA adapter and BNC to Banana Plug adapters as shown in **Figure 70**.
- 2 Position the PV fixture on a table top and clamp it with a small bench vise to steady it. Ensure that the PV fixture is flush with the table top so that when the banana plugs are probed, it does not rock the PV fixture.

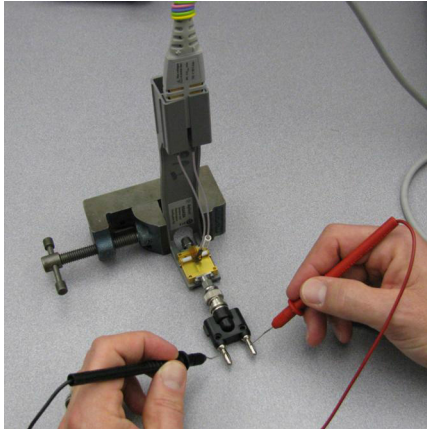

Figure 70 Measuring the differential input resistance of a ZIF or solder-in probe head

- 3 Connect the probe amplifier to the oscilloscope or power supply so it is powered.
- 4 Connect the ZIF or solder-in probe head to the probe amp and insert it into the PV fixture as shown **Figure 70**.
- 5 Depress the pincher fingers on the PV fixture so they open and carefully insert the tip wires under the pinchers. Release the pinchers once the tips are inserted.
- 6 As shown in **Figure 70**, measure the DC input resistance between the banana plugs. Since one tip wire is connected to the signal line and the other tip is connected to the PV fixture ground, this is a measurement of the differential input resistance. It should be 100 kOhms +/- 2% (98 to 102 kOhms).
- 7 To measure the single-ended input resistance, measure the resistance between the signal plug of the banana adapter and the probe amplifier ground, which can be accessed as shown in **Figure 71** (through the vent window of the probe amplifier).

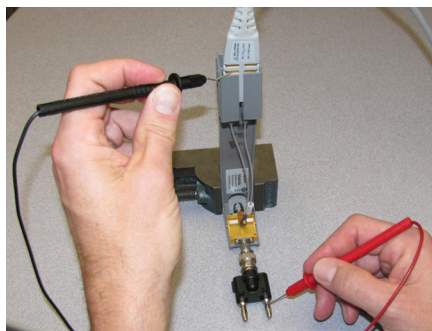

Figure 71 Measuring the single-ended input resistance of a ZIF or solder-in probe head

Measuring Input Resistance for the Browser Probe Head

The following image shows the correct setup for measuring the differential input resistance of the N5445A Browser probe head (**Figure 72**).

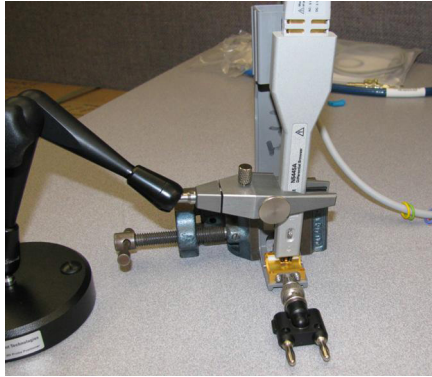

Figure 72 Setup for Measuring Input Resistance for Browser Probe Head

- 1 Set the browser for a fairly wide span (span does not impact this DC measurement).
- 2 Plug the probe amplifier into the browser.
- 3 Clamp the browser with the N2787A probe positioner.
- 4 Hold the browser with one hand and loosen the arm locking knob on the probe positioner with the other hand.
- 5 Carefully position one tip over the signal trace on the PV fixture and the other over the ground plane. Then let the weight of the browser slightly compress the tips so good contact is made.
- 6 Now the differential and single-ended input resistance can be measured in the same manner as for the ZIF and solder-in probe head procedure above.

Performance Test Record

NOTE

The recommended test interval is 1 Year/2000 hours.

Keysight Technologies	Keysight InfiniiMax III Series Probe
Model Number:	Tested by:
Serial Number:	Work Order Number:
Recommended next test date:	Date:

Probe Head (only required to test one)	Test Limits	Result	Pass/Fail
Bandwidth Performance Test			
N5439A with N5440A	≥ 26 GHz		
N5445A	≥ 28 GHz		
DC Input Resistance Performance Test			
N5439A with N5440A	98 to 102 kΩ (differential mode) 49 to 51 kΩ (single-ended mode)		
N5445A	98 to 102 kΩ (differential mode) 49 to 51 kΩ (single-ended mode)		
N5441A	98 to 102 kΩ (differential mode) 49 to 51 kΩ (single-ended mode)		

7 Performance Plots

MX0109A and N2836A 26 GHz Solder-In Probe Heads (with N2803A)	109
N2838A/N5439A 25 GHz PCB ZIF Tip/Head (with N2803A)	112
N5440A/N5439A 28 GHz Ceramic ZIF Tip/Head (with N2803A)	115
N5447A/N5439A 28 GHz Ceramic High-Sensitivity ZIF Tip/Head (with N2803A)	118
N5441A 16 GHz Solder-In Head (with N2803A)	121
N5444A 30 GHz SMA 2.92 mm Head (with N2803A)	124
N5445A 30 GHz Browser Head, 1 mm span (with N2803A)	127
N5445A 30 GHz Browser Head, 2 mm span (with N2803A)	130
N5445A 30 GHz Browser Head, 3 mm span (with N2803A)	133

The performance plots in this chapter are for the N2803A 30 GHz probe amplifier with various configurations InfiniiMax III probe heads. Items to note are:

- When InfiniiMax III probes are used with Keysight Infiniium 90000 X-Series Oscilloscopes (and the Keysight DCA-X Wide-Bandwidth Sampling Scopes in some cases), probe correction is applied to enhance the probe accuracy.
- Probe correction is computed from the s parameters of the various probe components such as probe heads, probe amps, and accessories.
- Typically, the largest variation in a probe's response is due to variation in the response of the probe amplifier. For the InfiniiMax III probes, the s parameters of each probe amplifier are measured at manufacture and stored in non-volatile memory in the probe amplifier, thus allowing the removal of this component of variation.
- If care is taken in the manufacture of the probe heads and other accessories, the variation in the probe response due to these components is minimal since they tend to be simple passive devices. Therefore, the s parameters for probe heads and other accessories are based on an average of a cross-section of parts. These nominal s parameters are stored in the oscilloscopes firmware based on the model number of the probe head or accessory and used in conjunction with the measured probe amplifiers s parameters to compute the overall probe correction.
- Since InfiniiMax III probes can be used with instruments that do not apply probe correction, the plots below show the response of a typical probe head and typical probe amp with no probe correction (i.e. probe hardware only) as well as the response with probe correction based on the nominal probe head s parameters and measured probe amp s parameters.
- Measurement data used for these plots and for determining probe correction were made using Keysight vector network analyzers swept to 40GHz and calibrated with NIST traceable calibration standards.

- Two time responses are shown:
 - “Time Response to an Ideal Step at Probe Tip” This is the classical “step response” which is defined as the time response to an ideal, zero rise-time step present at the probe tip. This can be determined accurately because the probe rolls off significantly within the 40GHz measurement range.
 - “Time Response to a 7ps Step at Probe Tip” This is the time response of the probe when measuring a step with the indicated 10%-90% rise-time present at the probe tip. The measured step is generated using a 5th order Bessel low pass filter that has an edge shape as shown in the plot showing the loading effect of the probe. The rise-time of this test step is picked to illustrate approximately the fastest step the probe can measure with less than 3% error in the rise-time measurement.

MX0109A and N2836A 26 GHz Solder-In Probe Heads (with N2803A)

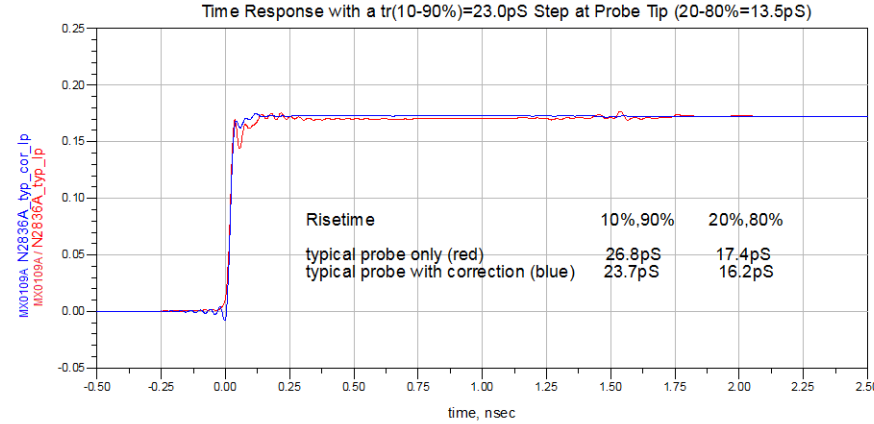
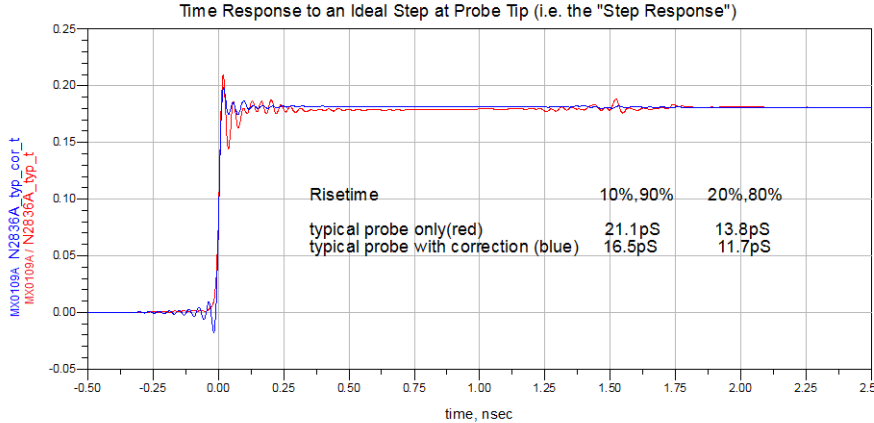
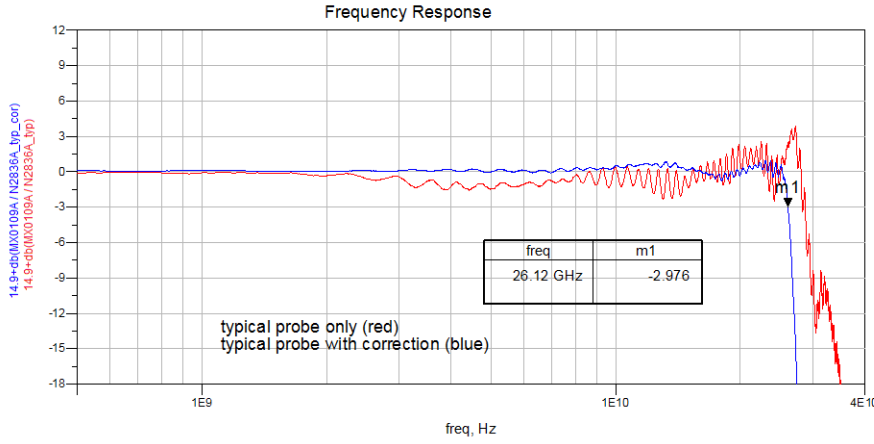

Loading Effect of Probe on $t_r(10-90\%)=15.6\text{pS}$ Step

red: differential 50 ohm source (100ohm line, source and load terminated) with no load applied
 blue: same source with differential probe loading applied

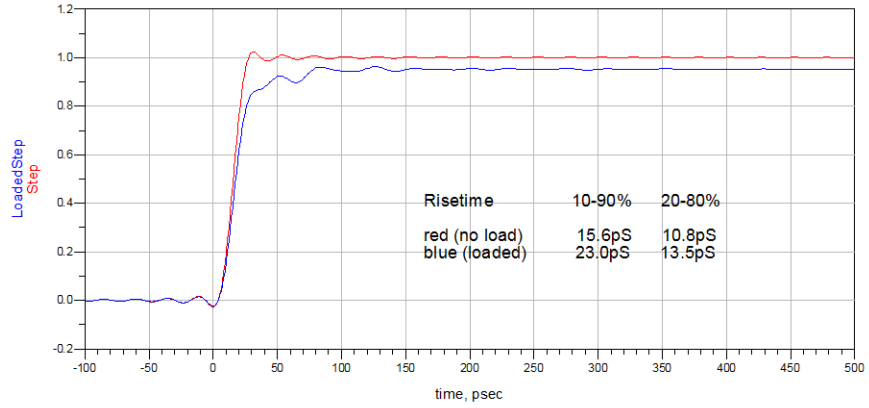

Single-Ended Input Impedance

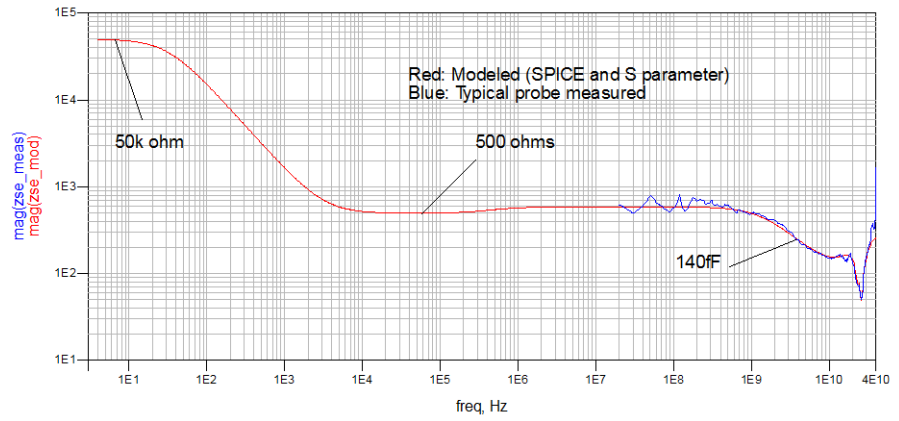

Differential Input Impedance

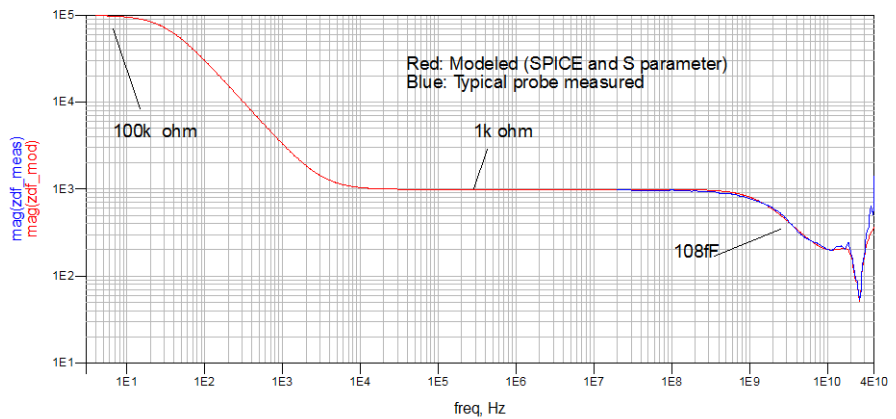

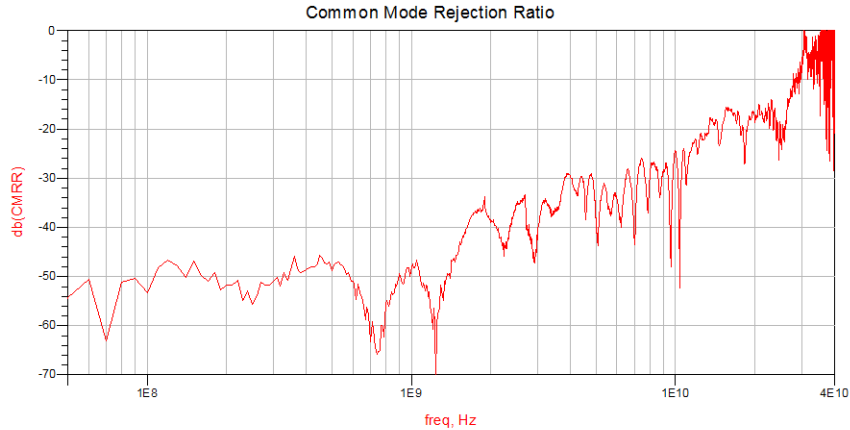

N2838A/N5439A 25 GHz PCB ZIF Tip/Head (with N2803A)

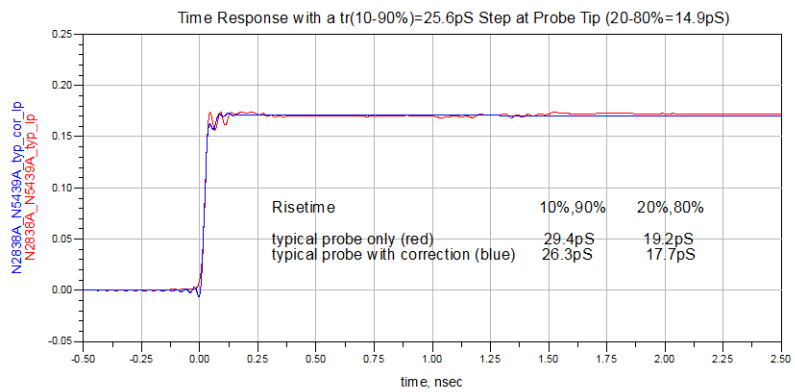
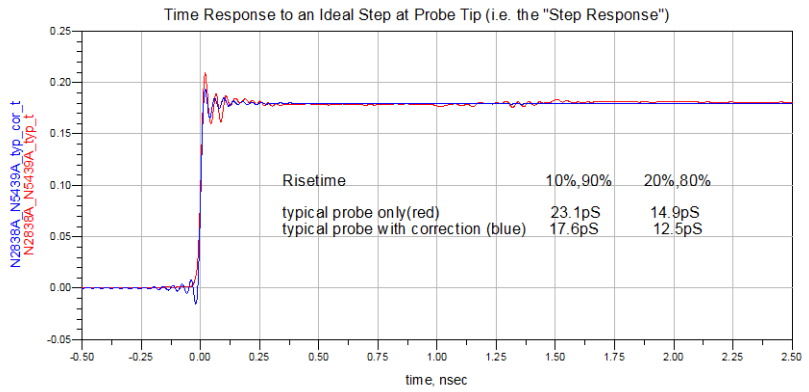
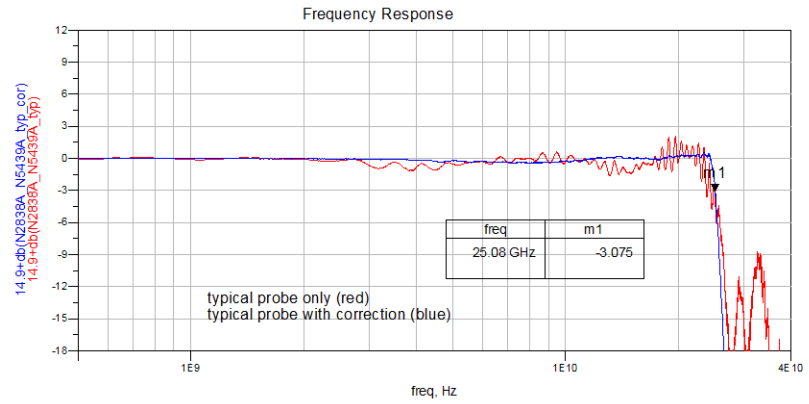

Loading Effect of Probe on $t_r(10-90\%)=17.2\text{pS}$ Step

red: differential 50 ohm source (100ohm line, source and load terminated) with no load applied
blue: same source with differential probe loading applied

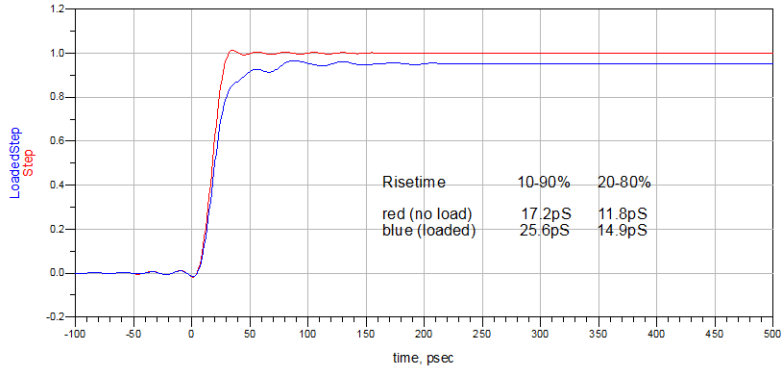

Single-Ended Input Impedance

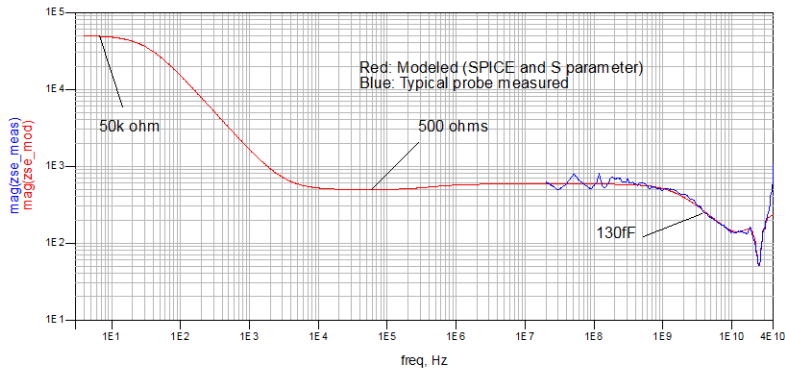

Differential Input Impedance

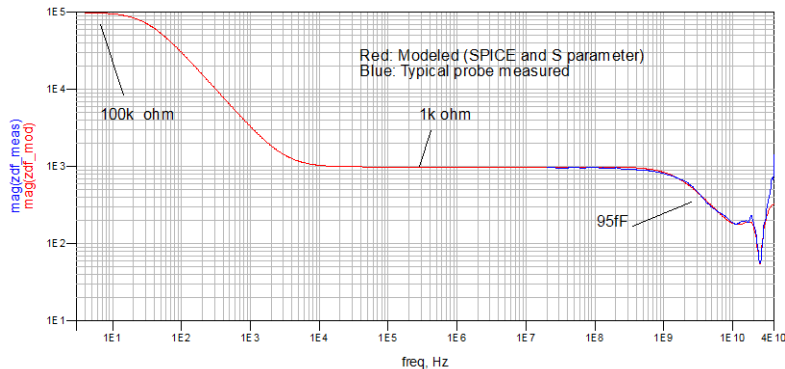

7 Performance Plots

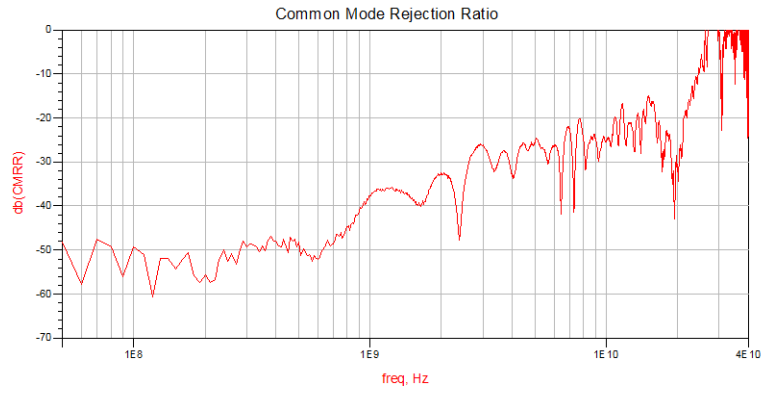

N5440A/N5439A 28 GHz Ceramic ZIF Tip/Head (with N2803A)

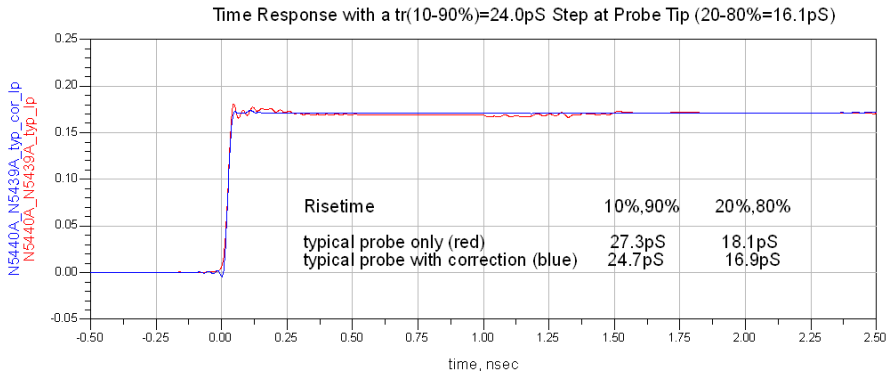
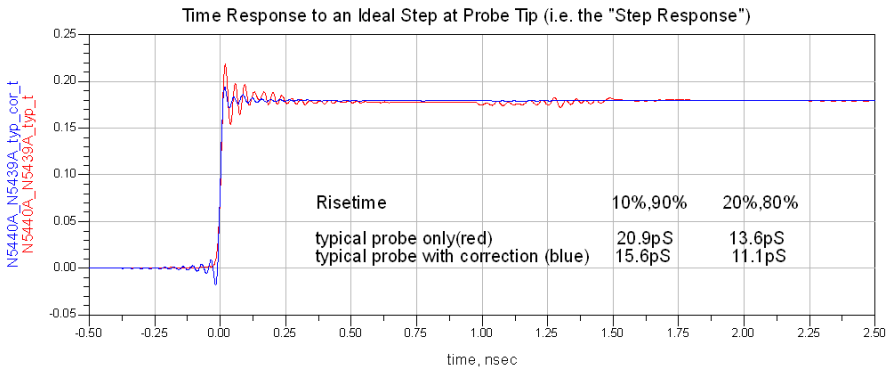
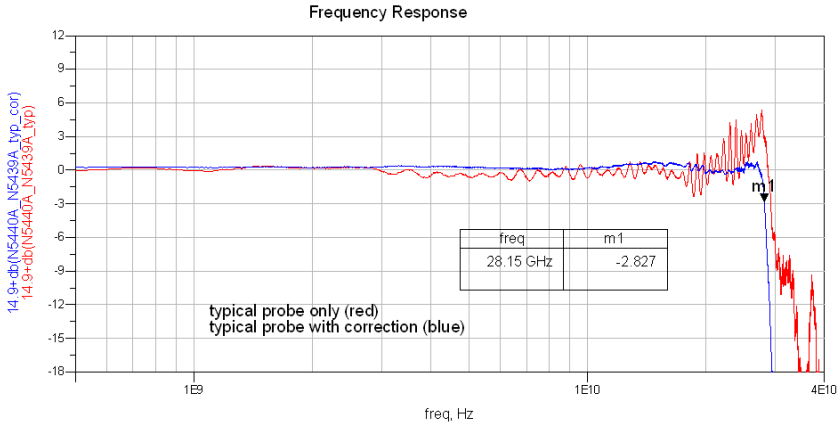

Loading Effect of Probe on $t_r(10-90\%)=21.0\text{pS}$ Step

red: differential 50 ohm source (100ohm line, source and load terminated) with no load applied
 blue: same source with differential probe loading applied

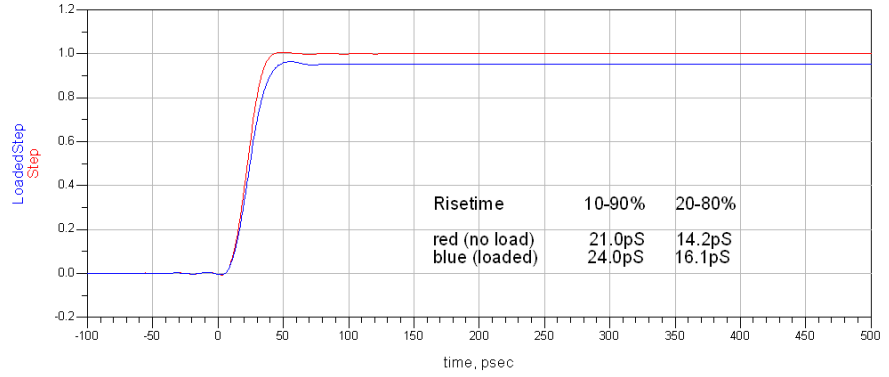

Single-Ended Input Impedance

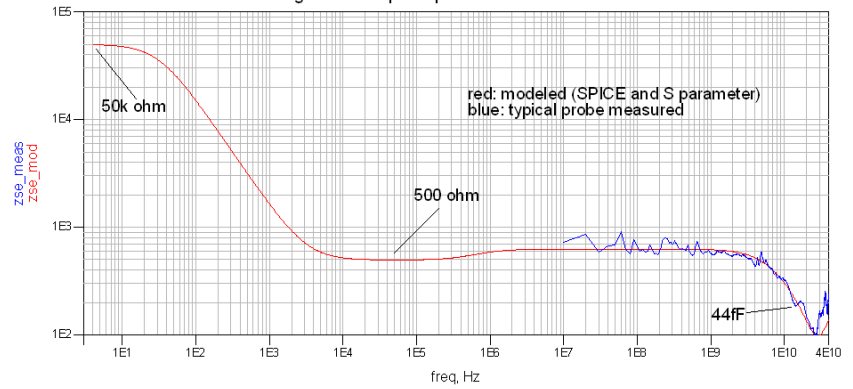

Differential Input Impedance

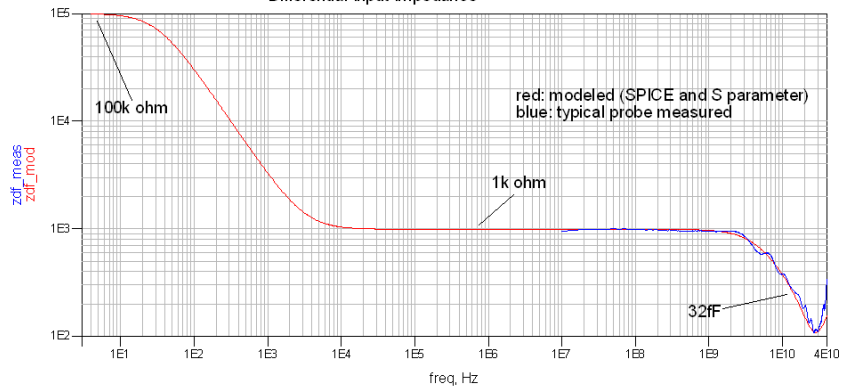

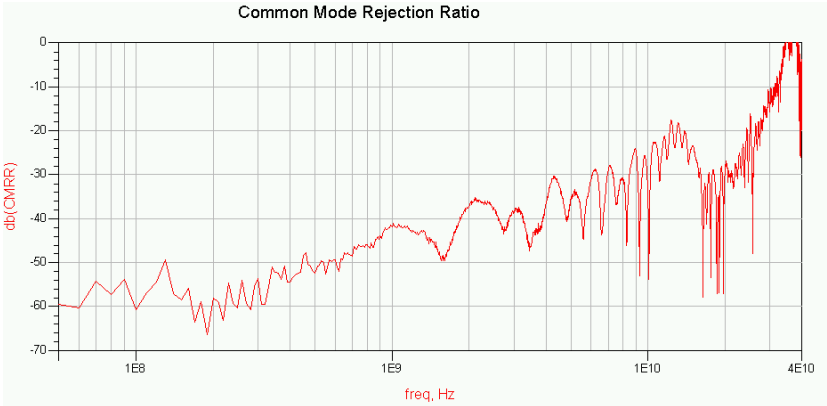

N5447A/N5439A 28 GHz Ceramic High-Sensitivity ZIF Tip/Head (with N2803A)

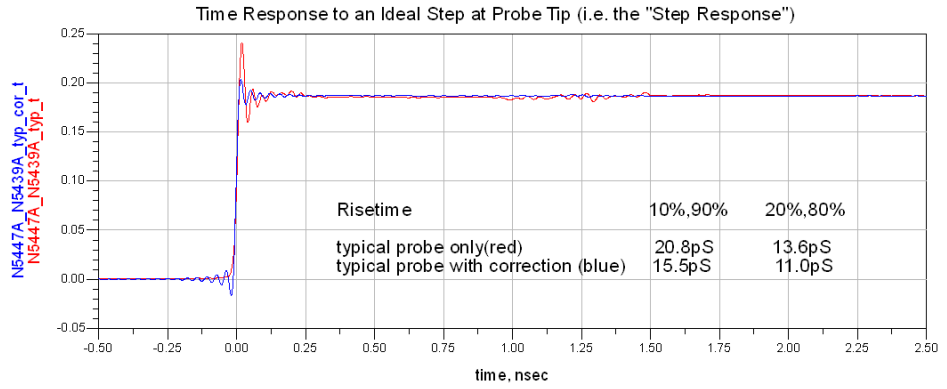
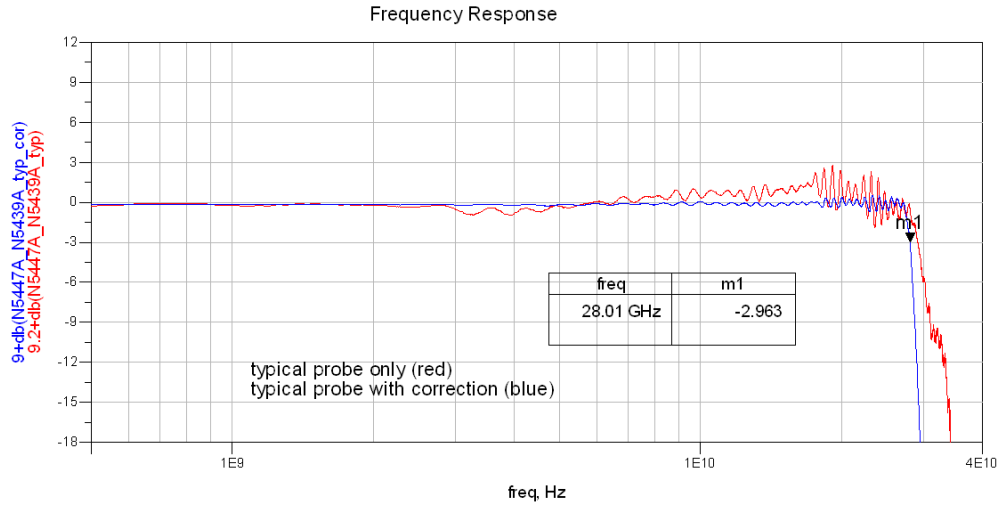

Time Response with a $t_r(10-90\%)=24.0\text{pS}$ Step at Probe Tip ($20-80\%=15.8\text{pS}$)

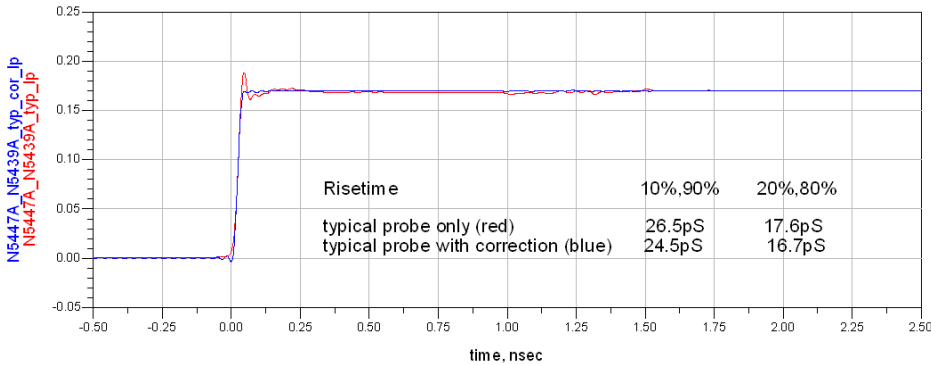

Loading effect of Probe on $t_r(10-90\%)=21.3\text{pS}$ Step

red: differential 50 ohm source (100ohm line, source and load terminated) with no load applied
 blue: same source with differential probe loading applied

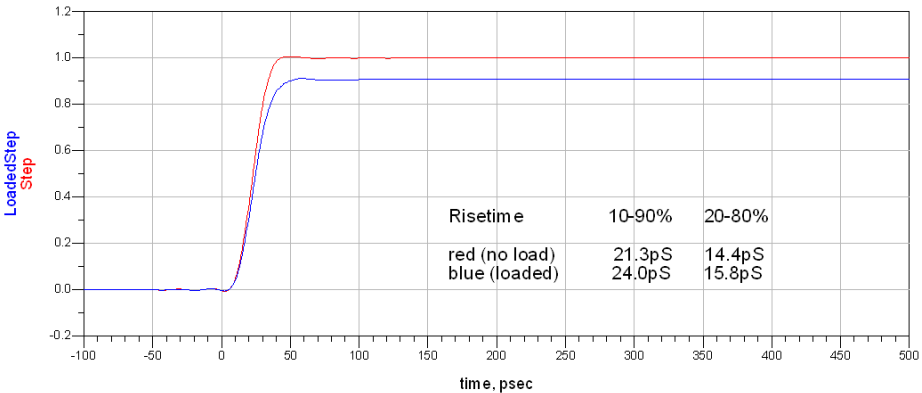

Single-Ended Input Impedance

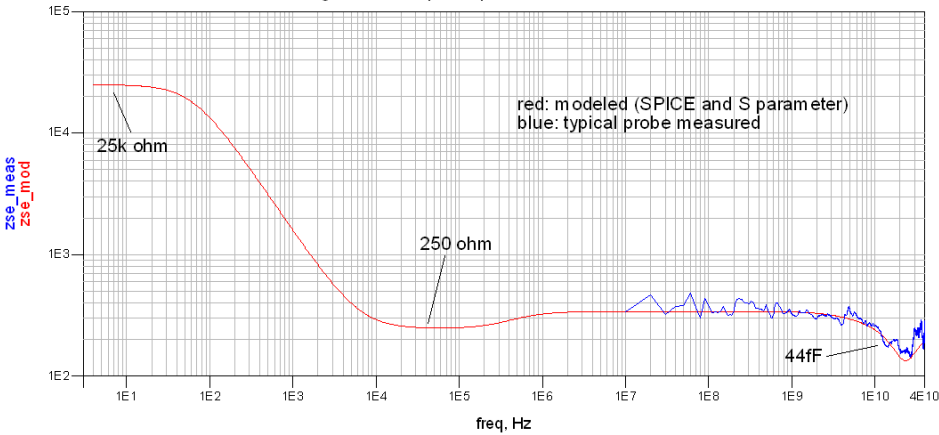

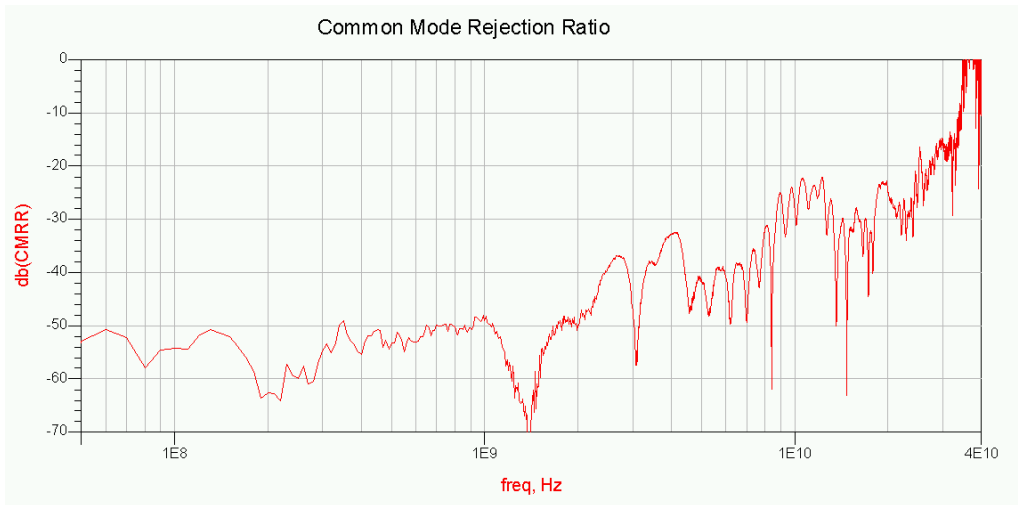
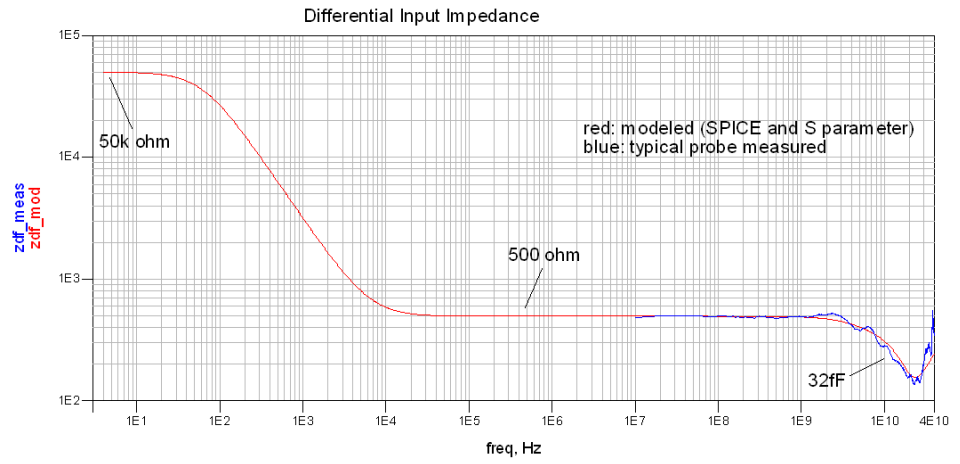

N5441A 16 GHz Solder-In Head (with N2803A)

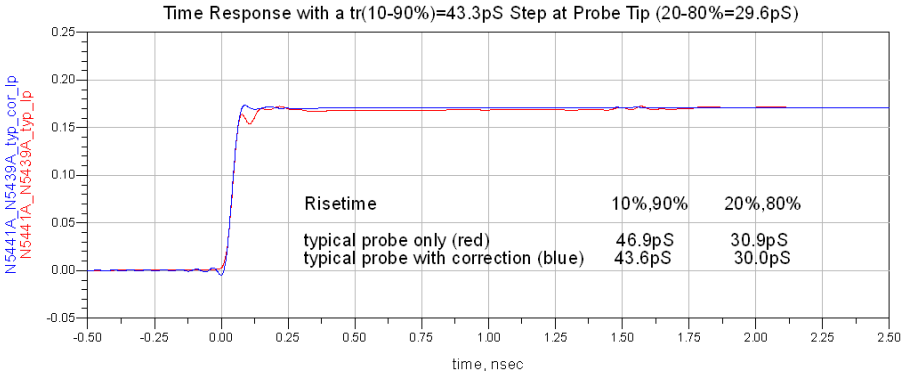
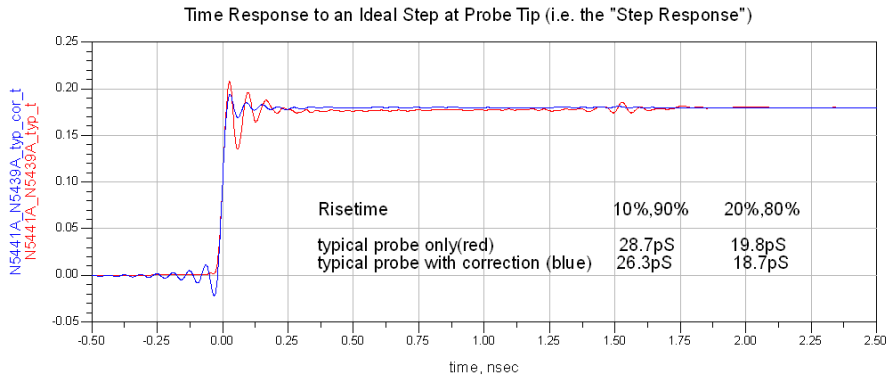
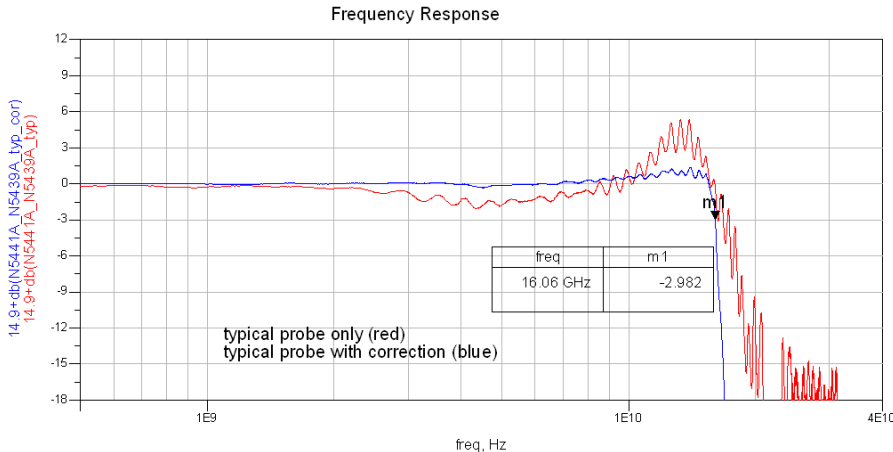

Loading Effect of Probe on $t_r(10-90\%)=15.6\text{pS}$ Step

red: differential 50 ohm source (100ohm line, source and load terminated) with no load applied
 blue: same source with differential probe loading applied

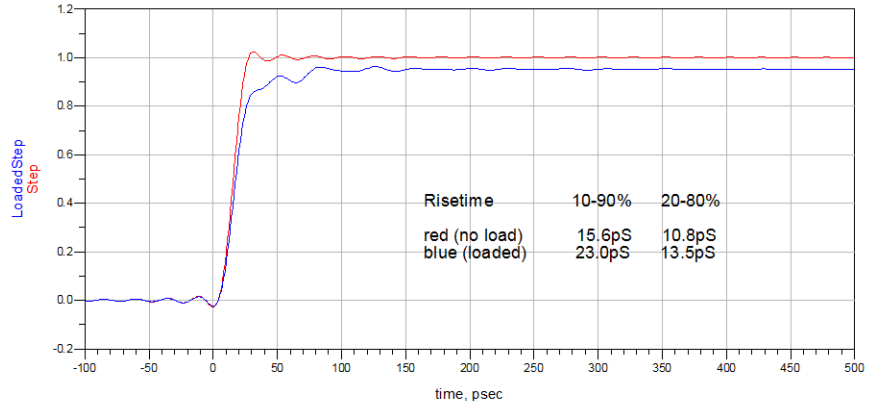

Single-Ended Input Impedance

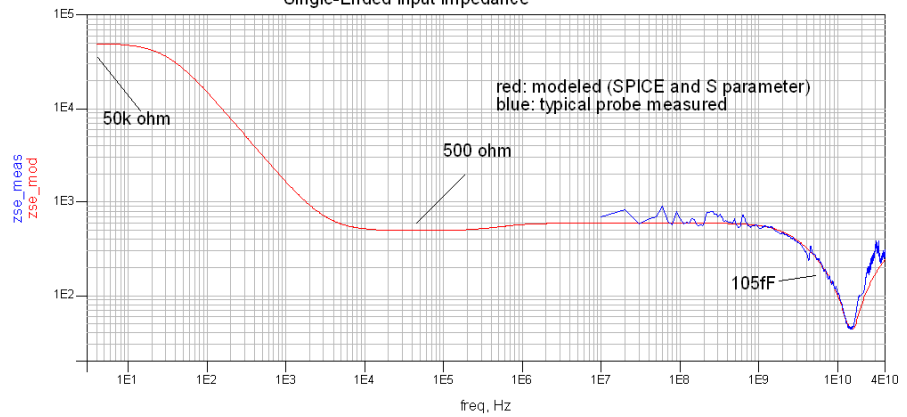

Differential Input Impedance

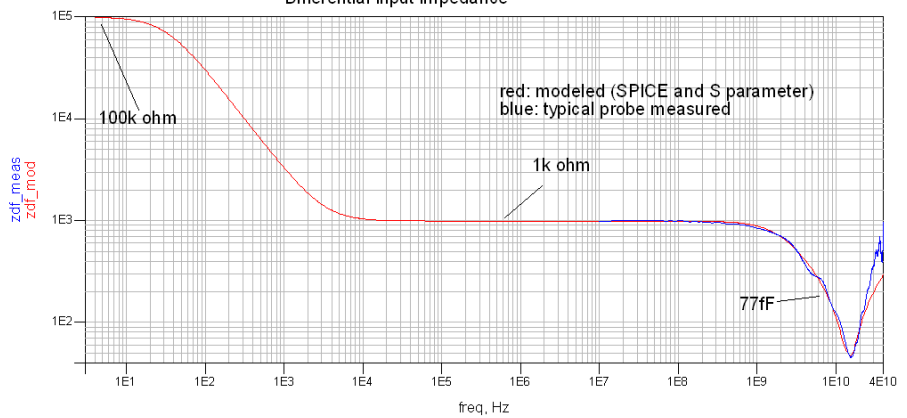

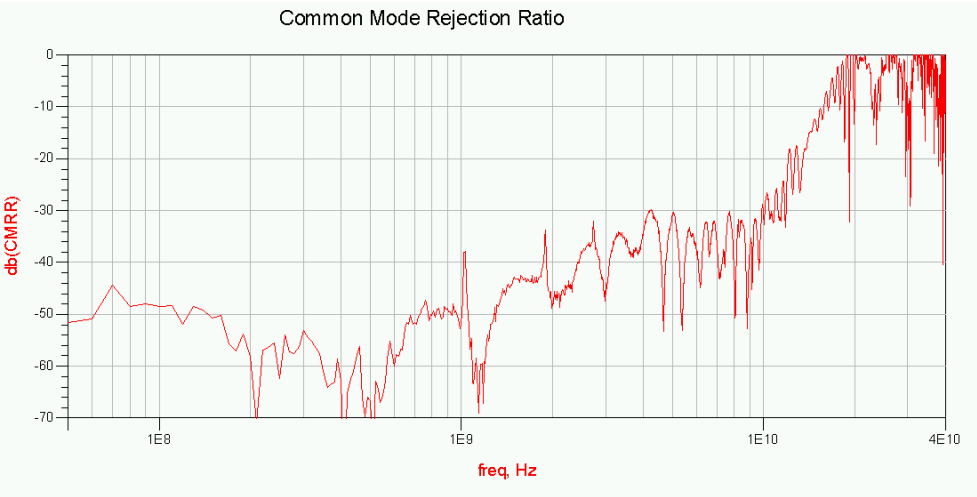

N5444A 30 GHz SMA 2.92 mm Head (with N2803A)

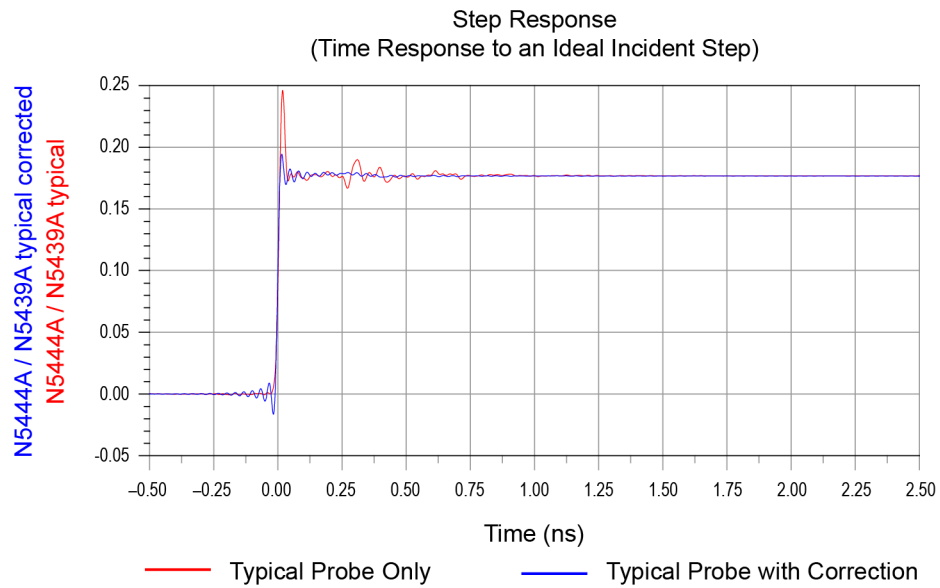
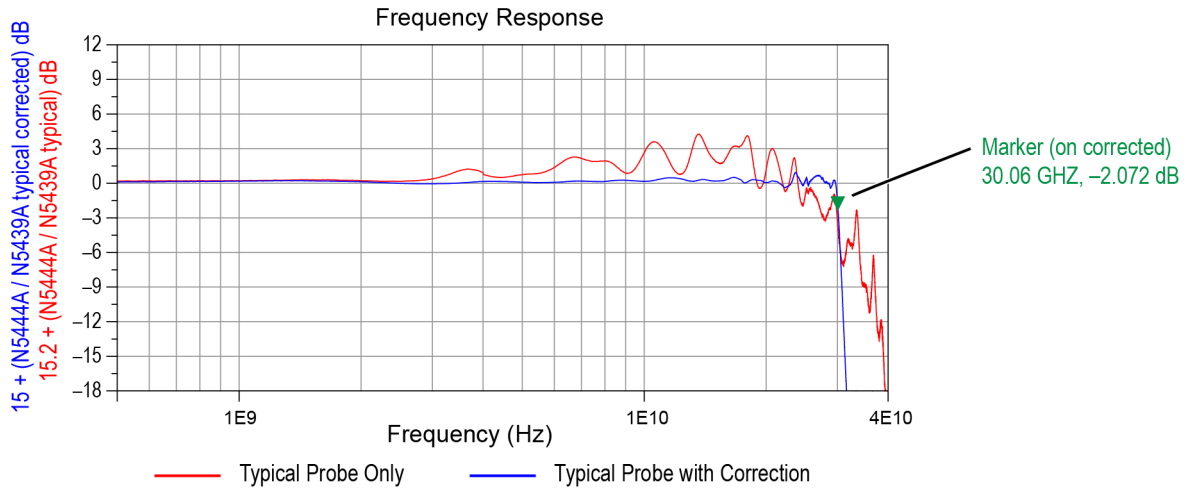

Risetime:	10%, 90%	20%, 80%
Typical Probe Only:	17.0 ps	11.3 ps
Typical Probe with Correction:	14.3 ps	10.2 ps

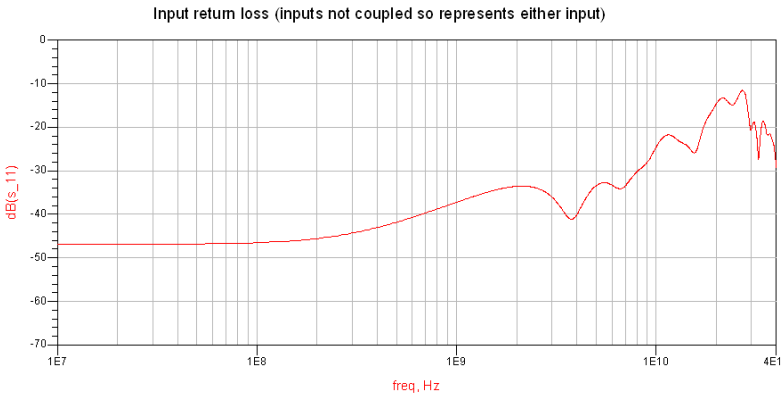
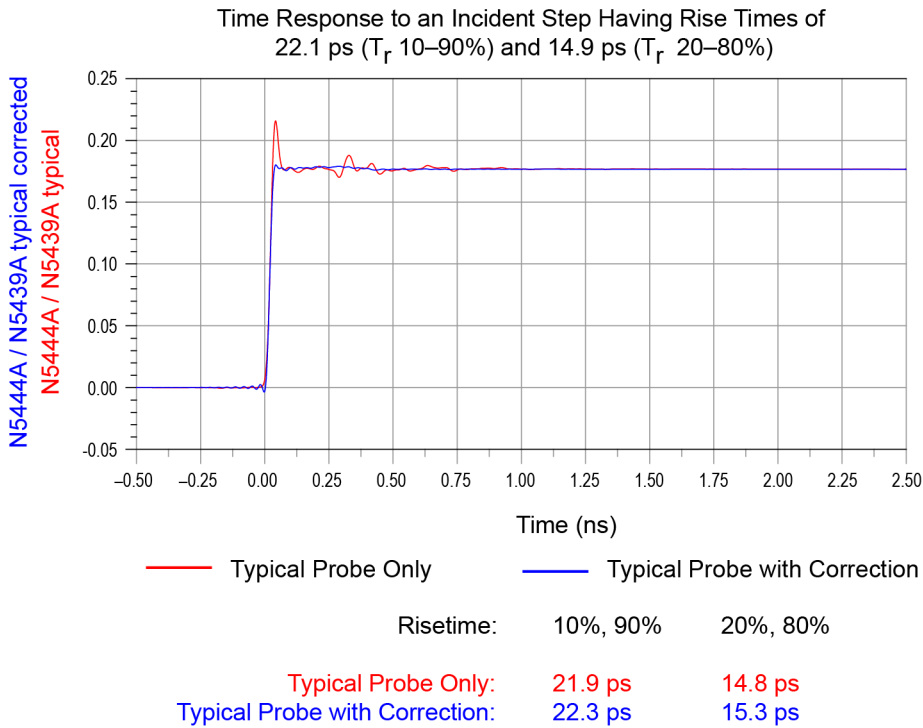

t

7 Performance Plots

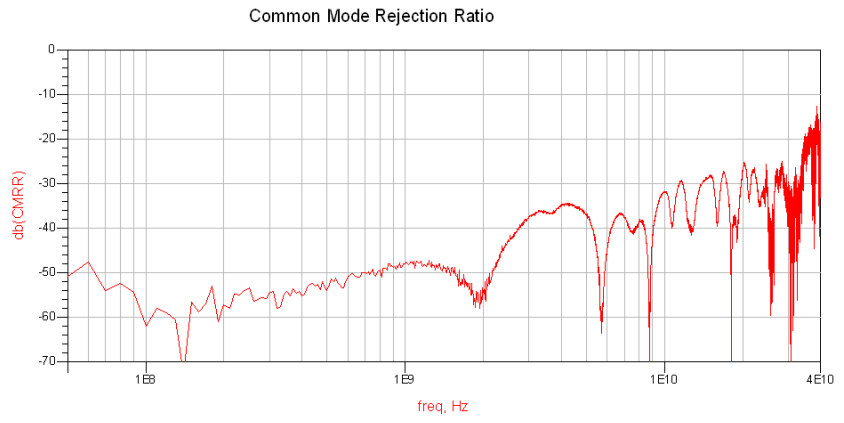

N5445A 30 GHz Browser Head, 1 mm span (with N2803A)

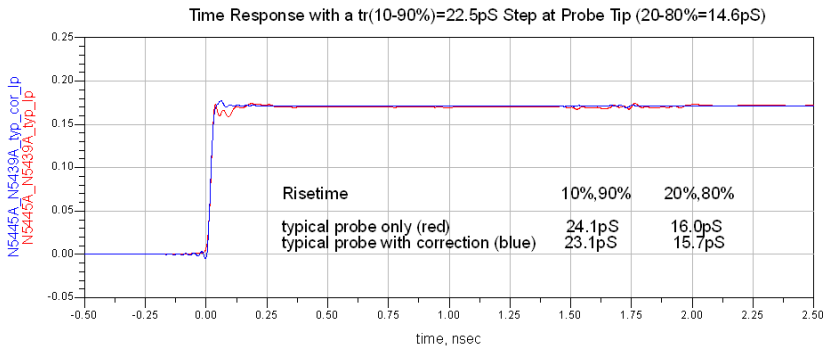
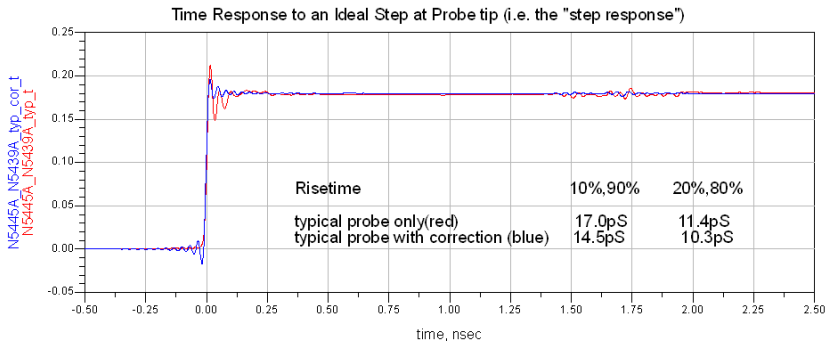
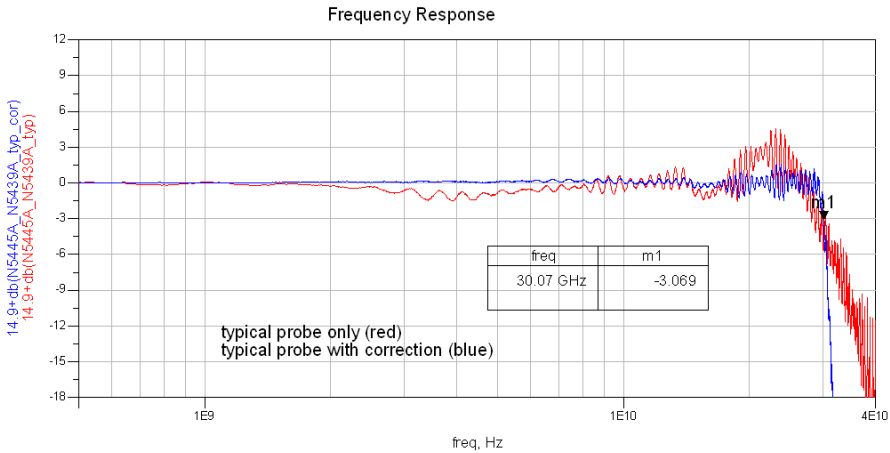

Loading Effect of Probe on $t_r(10-90\%)=17.9\text{pS}$ Step

red: differential 50 ohm source (100ohm line, source and load terminated) with no load applied
 blue: same source with differential probe loading applied

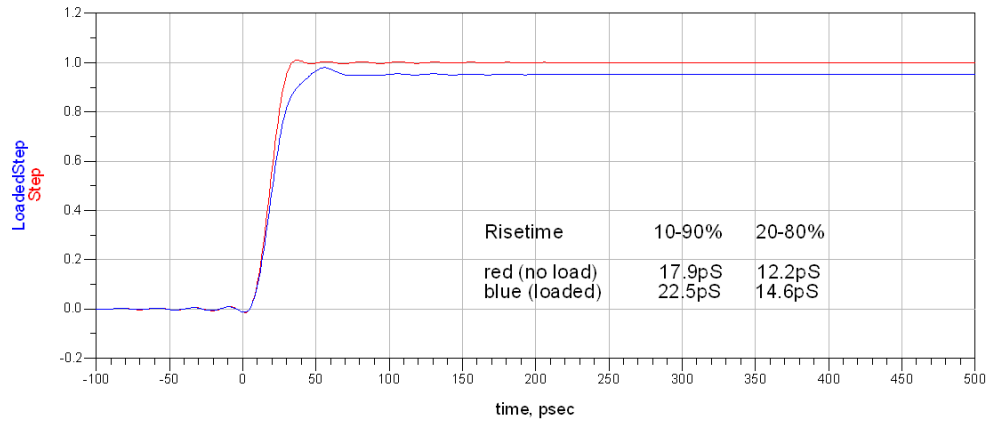

Single-Ended Input Impedance

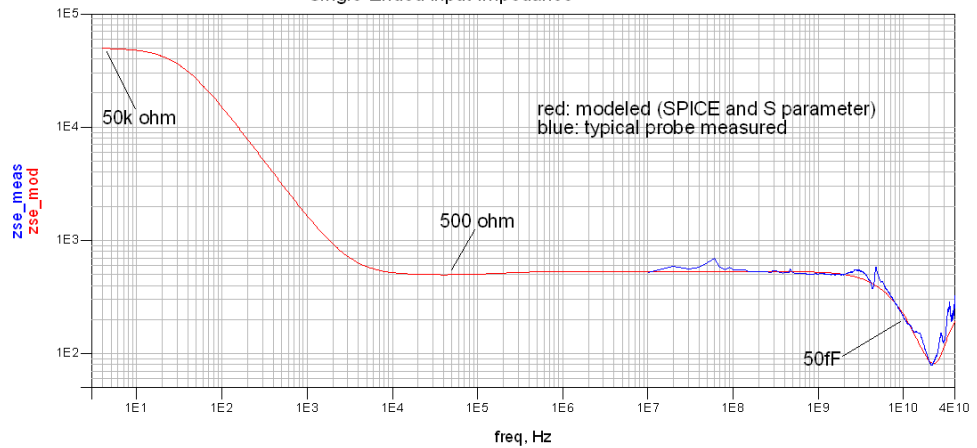

Differential Input Impedance

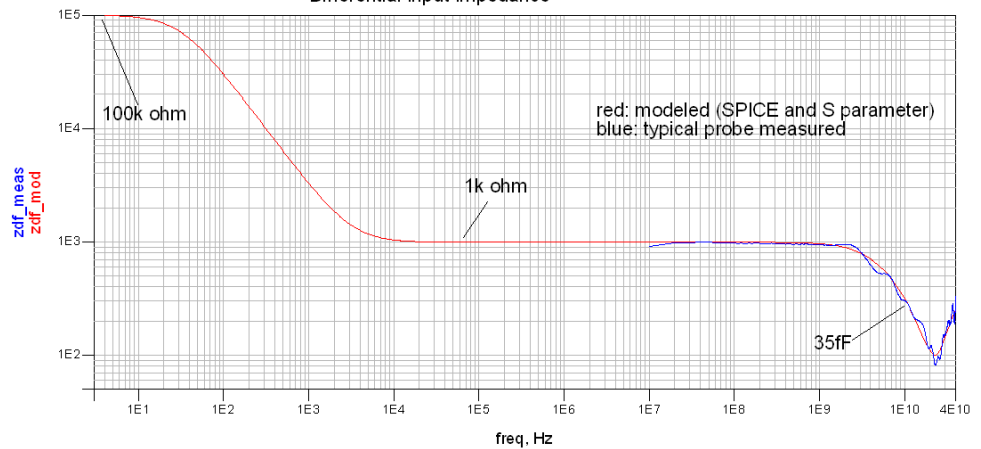

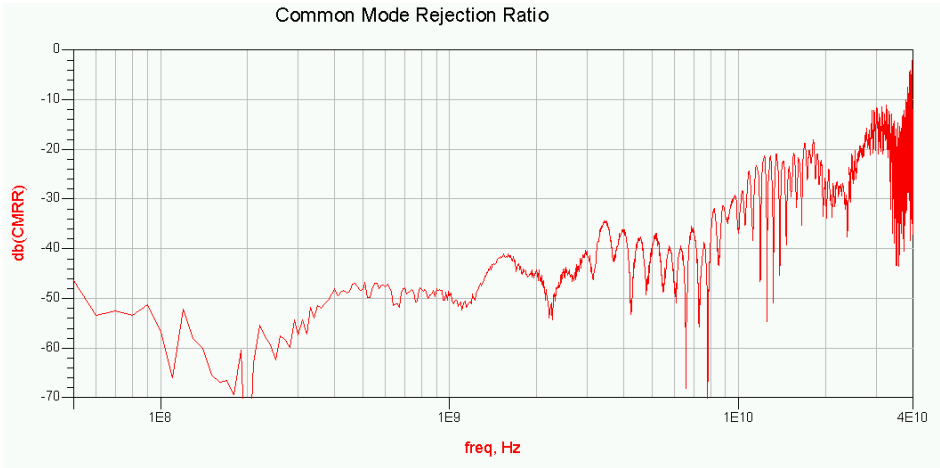

N5445A 30 GHz Browser Head, 2 mm span (with N2803A)

NOTE

For browser spans of 2 and 3mm, the biggest effect is in the frequency and time responses. The input loading is nearly the same as for the 1mm span except that the impedance minimum at ~22 GHz is slightly higher.

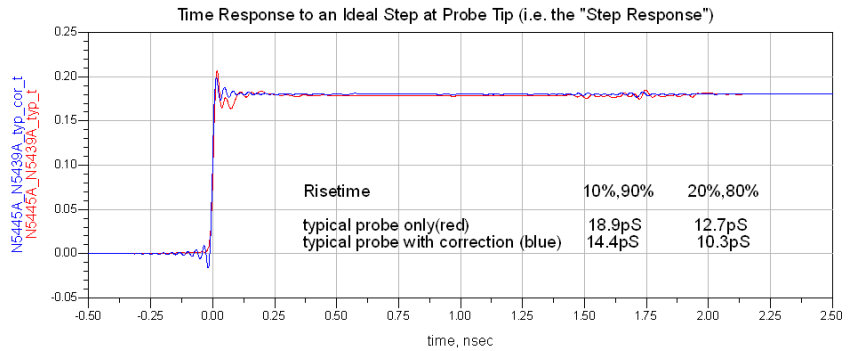
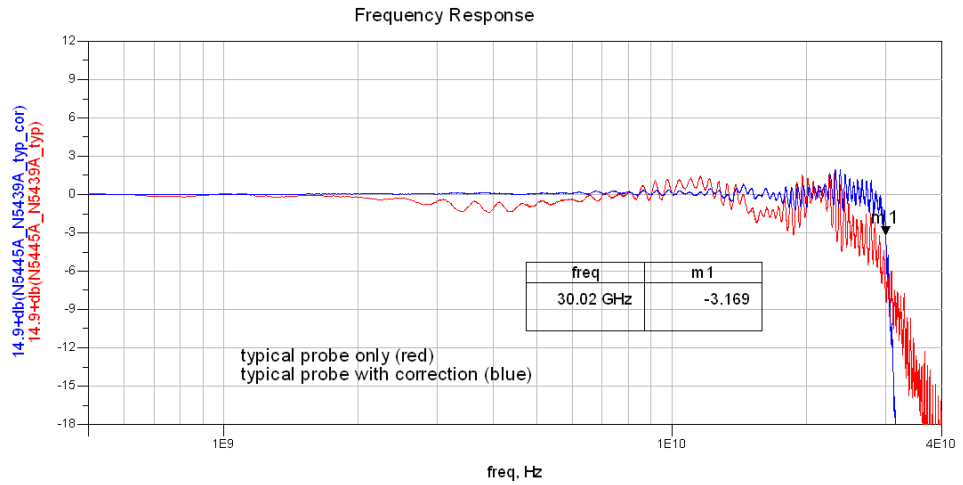

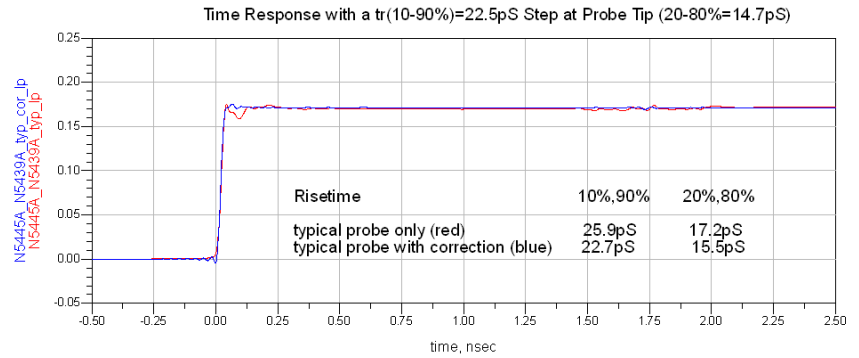

Loading Effect of Probe on $t_r(10-90\%)=18.6\text{pS}$ Step

red: differential 50 ohm source (100ohm line, source and load terminated) with no load applied
 blue: same source with differential probe loading applied

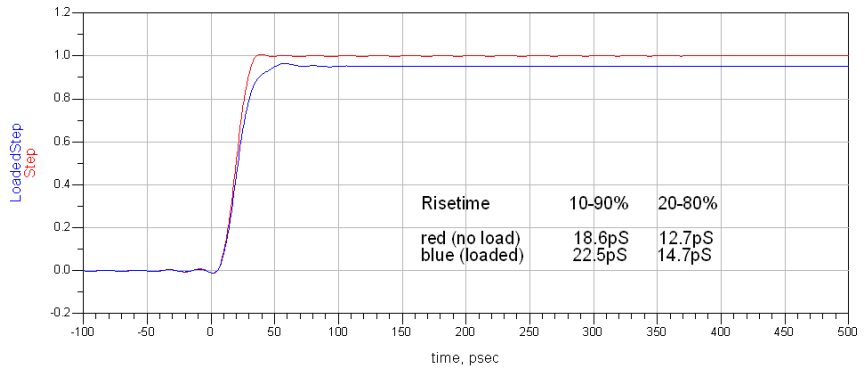

Single-Ended Input Impedance

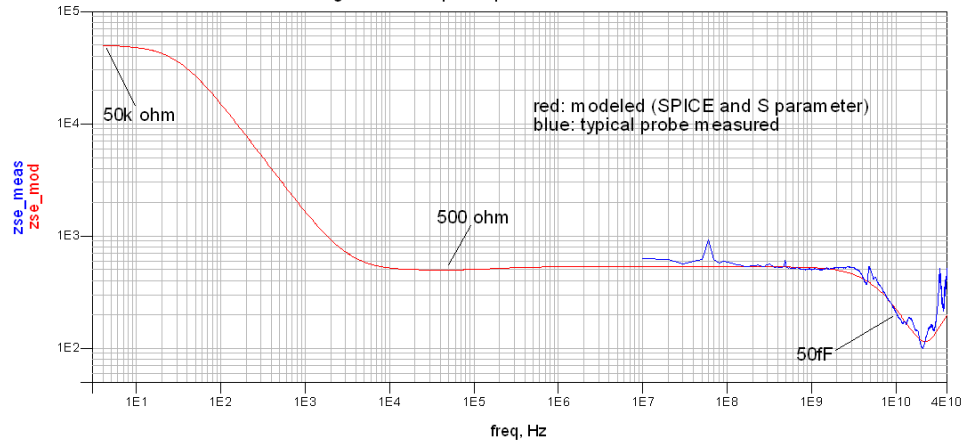

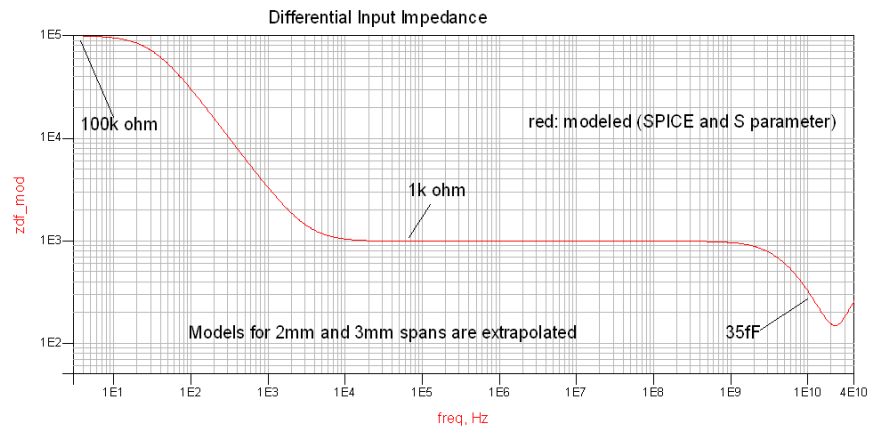

N5445A 30 GHz Browser Head, 3 mm span (with N2803A)

NOTE

For browser spans of 2 and 3mm, the biggest effect is in the frequency and time responses. The input loading is nearly the same as for the 1mm span except that the impedance minimum at ~22 GHz is slightly higher.

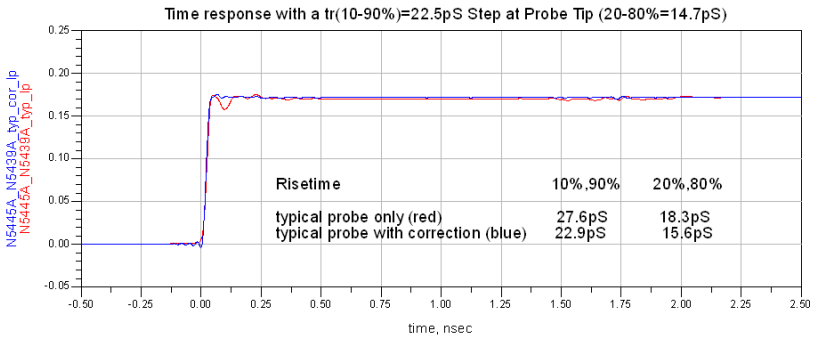
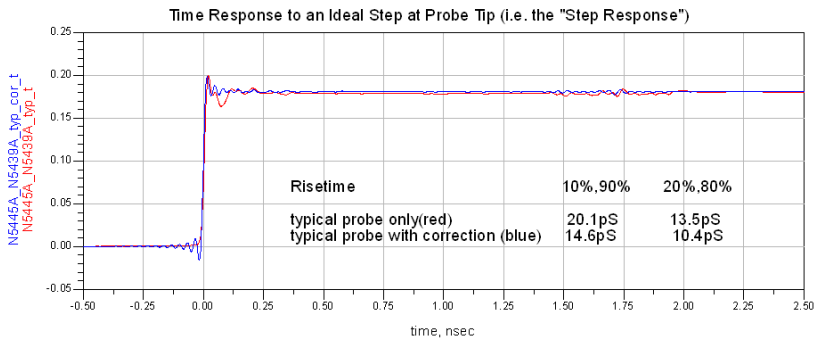
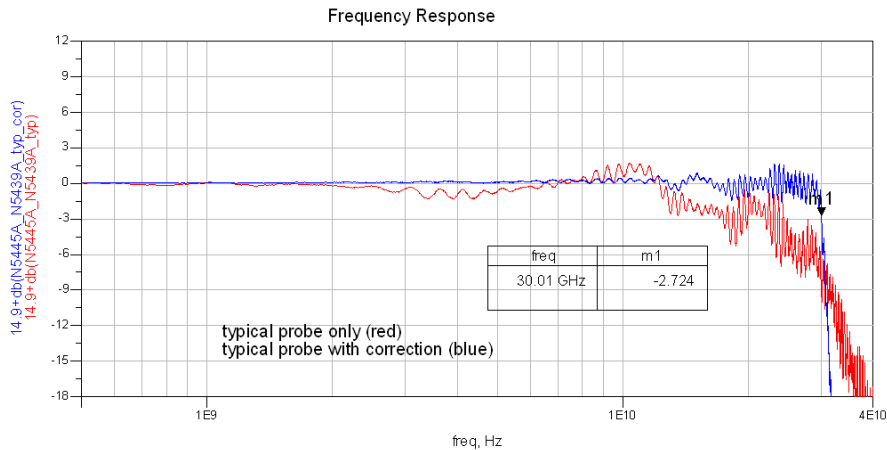

Loading Effect of Probe on $t_r(10-90\%)=19.0\text{pS}$ Step

red: differential 50 ohm source (100ohm line, source and load terminated) with no load applied
 blue: same source with differential probe loading applied

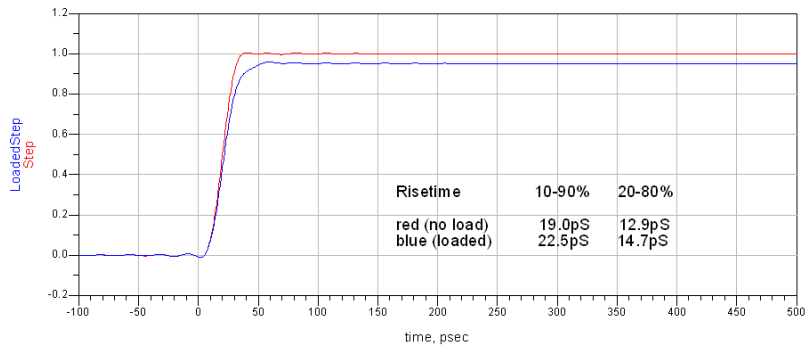

Single-Ended Input Impedance

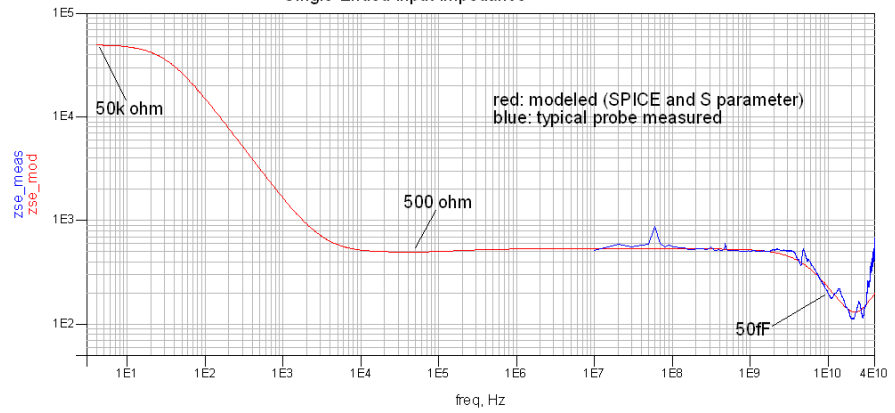

Differential Input Impedance

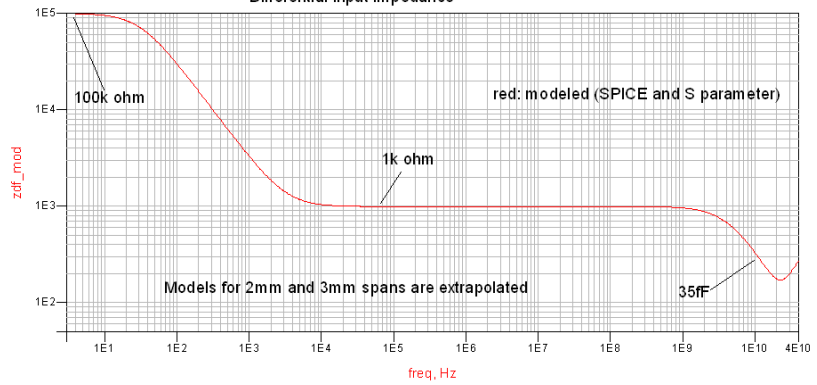

8 SPICE Models

SPICE Models for N5440/1/4/5/7A Probe Heads	136
SPICE Models for N2838A, MX0109A, and N2836A Probe Heads	142
Simplified InfiniiMax III Schematic	145

The SPICE models in this chapter are for the input impedances of the various Infiniimax III probes heads. The input impedance is only a function of the probe head, as the amplifier input does not significantly affect the input impedance.

Chapter 7, “Performance Plots shows the matching between the measured input impedance and these modeled input impedances for various probe heads.

SPICE Models for N5440/1/4/5/7A Probe Heads

The SPICE models in this section are for the input impedances of the various InfiniiMax III probes. Generic SPICE sub-circuit files are listed so they can be copied and pasted into user's SPICE simulations.

Chapter 7, "Performance Plots" shows the matching between the measured input impedance and these modeled input impedances for the various probe heads.

Figure 73 on page 137 shows the SPICE circuit used for these probe heads:

- N5440A 28 GHz ceramic ZIF Tips (with N5439A ZIF Probe Head)
- N5447A 28 GHz ceramic high-sensitivity ZIF Tips (with N5439A ZIF Probe Head)
- N5441A 16 GHz solder-in probe head
- N5445A browser probe head
- N5444A SMA probe head

The input impedance is only a function of the probe head; the amplifier input does not significantly affect the input impedance.

NOTE

You'll find the following SPICE data on the documentation CD that was shipped with your probe. Copying this data from the CD is the simplest most reliable method to get the data.

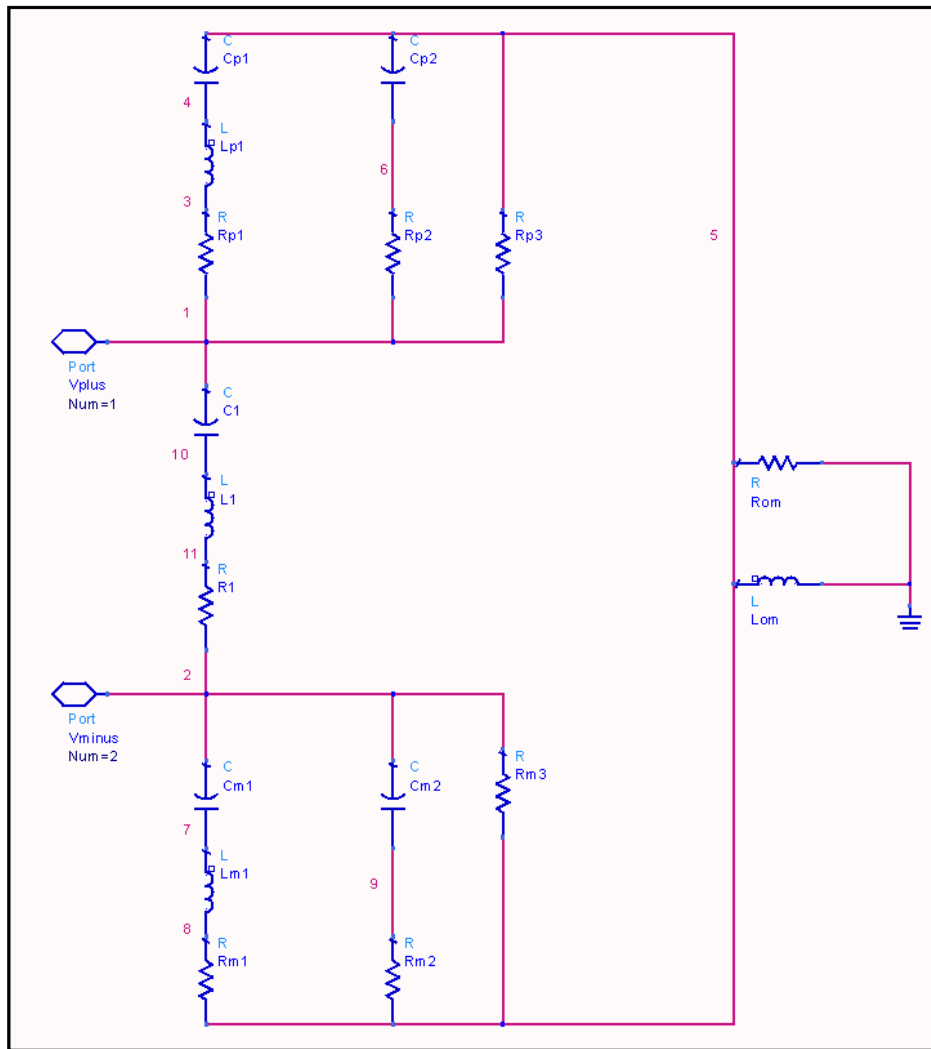

Figure 73 SPICE circuit for N5440A, N5447A, N5441A, N5445A, and N5444A probe heads

N5440A Ceramic ZIF Tip, N5439A ZIF Probe Head

For matching between the modeled and measured input impedances, refer to ["N5440A/N5439A 28 GHz Ceramic ZIF Tip/Head \(with N2803A\)"](#) on page 115.

```
.subckt N5440A_N5439A_450ohmZIF 1 2
c1 1 10 20f
l1 10 11 1.5n
r1 11 2 180
rp1 1 3 180
lp1 3 4 1.5n
cp1 4 5 24f
cp2 5 6 100n
rp2 6 1 500
rp3 5 1 50k
cm1 2 7 24f
lm1 7 8 1.5n
rm1 8 5 180
cm2 2 9 100n
rm2 9 5 500
rm3 2 5 50k
rom 5 0 180
lom 5 0 30u
.ends
```

N5447A Ceramic High Sensitivity ZIF Tip, N5439A ZIF Probe Head

For matching between the modeled and measured input impedances, refer to ["N5447A/N5439A 28 GHz Ceramic High-Sensitivity ZIF Tip/Head \(with N2803A\)"](#) on page 118.

```
.subckt N5447A_N5439A_200ohmZIF 1 2
c1 1 10 20f
l1 10 11 2.3n
r1 11 2 250
rp1 1 3 1.2k
lp1 3 4 2.3n
cp1 4 5 24f
cp2 5 6 100n
rp2 6 1 250
rp3 5 1 25k
cm1 2 7 24f
lm1 7 8 2.3n
rm1 8 5 1.2k
cm2 2 9 100n
rm2 9 5 250
rm3 2 5 25k
rom 5 0 150
lom 5 0 30u
.ends
```

N5441A Solder-In Probe Head

For matching between the modeled and measured input impedances, refer to **“N5441A 16 GHz Solder-In Head (with N2803A)”** on page 121.

```
.subckt N5441A_SldrIn 1 2
c1 1 10 50f
l1 10 11 2.1n
r1 11 2 65
rp1 1 3 65
lp1 3 4 2.5n
cp1 4 5 55f
cp2 5 6 100n
rp2 6 1 500
rp3 5 1 50k
cm1 2 7 55f
lm1 7 8 2.5n
rm1 8 5 65
cm2 2 9 100n
rm2 9 5 500
rm3 2 5 50k
rom 5 0 130
lom 5 0 30u
.ends
```

N5445A Browser Probe Head (1 mm span)

For matching between the modeled and measured input impedances, refer to **“N5445A 30 GHz Browser Head, 1 mm span (with N2803A)”** on page 127.

```
.subckt N5445A_Brwsr1mmSpn 1 2
c1 1 10 20f
l1 10 11 2.3n
r1 11 2 150
rp1 1 3 150
lp1 3 4 2.3n
cp1 4 5 30f
cp2 5 6 100n
rp2 6 1 500
rp3 5 1 50k
cm1 2 7 30f
lm1 7 8 2.3n
rm1 8 5 150
cm2 2 9 100n
rm2 9 5 500
rm3 2 5 50k
rom 5 0 40
lom 5 0 30u
.ends
```

N5445A Browser Probe Head (2 mm span)

For matching between the modeled and measured input impedances, refer to **“N5445A 30 GHz Browser Head, 2 mm span (with N2803A)”** on page 130.

```
.subckt N5445A_Brwsr2mmSpn 1 2
c1 1 10 20f
l1 10 11 2.3n
r1 11 2 250
rp1 1 3 250
lp1 3 4 2.3n
cp1 4 5 30f
cp2 5 6 100n
rp2 6 1 500
rp3 5 1 50k
cm1 2 7 30f
lm1 7 8 2.3n
rm1 8 5 250
cm2 2 9 100n
rm2 9 5 500
rm3 2 5 50k
rom 5 0 40
lom 5 0 30u
.ends
```

N5445A Browser Probe Head (3 mm span)

For matching between the modeled and measured input impedances, refer to **“N5445A 30 GHz Browser Head, 3 mm span (with N2803A)”** on page 133.

```
.subckt N5445A_Brwsr3mmSpn 1 2
c1 1 10 20f
l1 10 11 2.3n
r1 11 2 300
rp1 1 3 300
lp1 3 4 2.3n
cp1 4 5 30f
cp2 5 6 100n
rp2 6 1 500
rp3 5 1 50k
cm1 2 7 30f
lm1 7 8 2.3n
rm1 8 5 300
cm2 2 9 100n
rm2 9 5 500
rm3 2 5 50k
rom 5 0 40
lom 5 0 30u
.ends
```

N5444A SMA Probe Head

The N5444A 2.92 mm/3.5 mm/SMA probe head is modeled by 40 short transmission lines of varying impedance. This accurately models the temporal nature of this probe head. The sub-circuit text is:

For matching between the modeled and measured input impedances, refer to **"N5444A 30 GHz SMA 2.92 mm Head (with N2803A)"** on page 124.

```
.subckt N5444A_2p92mm 01
t01 01 0 02 0 z0=50.1226 td=4.5p
t02 02 0 03 0 z0=48.6767 td=4.5p
t03 03 0 04 0 z0=50.0690 td=4.5p
t04 04 0 05 0 z0=50.1226 td=4.5p
t05 05 0 06 0 z0=47.8189 td=4.5p
t06 06 0 07 0 z0=48.4842 td=4.5p
t07 07 0 08 0 z0=51.5636 td=4.5p
t08 08 0 09 0 z0=51.3432 td=4.5p
t09 09 0 10 0 z0=50.1231 td=4.5p
t10 10 0 11 0 z0=50.9715 td=4.5p
t11 11 0 12 0 z0=51.2048 td=4.5p
t12 12 0 13 0 z0=49.3079 td=4.5p
t13 13 0 14 0 z0=48.3903 td=4.5p
t14 14 0 15 0 z0=50.1144 td=4.5p
t15 15 0 16 0 z0=51.9126 td=4.5p
t16 16 0 17 0 z0=51.1671 td=4.5p
t17 17 0 18 0 z0=48.7858 td=4.5p
t18 18 0 19 0 z0=49.7704 td=4.5p
t19 19 0 20 0 z0=54.9662 td=4.5p
t20 20 0 21 0 z0=55.6338 td=4.5p
t21 21 0 22 0 z0=50.6714 td=4.5p
t22 22 0 23 0 z0=47.9673 td=4.5p
t23 23 0 24 0 z0=48.6942 td=4.5p
t24 24 0 25 0 z0=51.3949 td=4.5p
t25 25 0 26 0 z0=52.4910 td=4.5p
t26 26 0 27 0 z0=50.3990 td=4.5p
t27 27 0 28 0 z0=49.9508 td=4.5p
t28 28 0 29 0 z0=50.5692 td=4.5p
t29 29 0 30 0 z0=49.8539 td=4.5p
t30 30 0 31 0 z0=51.6006 td=4.5p
t31 31 0 32 0 z0=49.4657 td=4.5p
t32 32 0 33 0 z0=51.3932 td=4.5p
t33 33 0 34 0 z0=50.6702 td=4.5p
t34 34 0 35 0 z0=50.1108 td=4.5p
t35 35 0 36 0 z0=50.9072 td=4.5p
t36 36 0 37 0 z0=50.6940 td=4.5p
t37 37 0 38 0 z0=50.1733 td=4.5p
t38 38 0 39 0 z0=50.2609 td=4.5p
t39 39 0 40 0 z0=50.1355 td=4.5p
t40 40 0 41 0 z0=51.2333 td=4.5p
rterm 41 0 50.3
.ends
```

SPICE Models for N2838A, MX0109A, and N2836A Probe Heads

These are SPICE models for the input impedances of the various InfiniiMax III probes. Generic SPICE sub-circuit files are listed so they can be copied and pasted into user's SPICE simulations.

Chapter 7, "Performance Plots" shows the matching between the measured input impedance and these modeled input impedances for the various probe heads.

The following diagram shows the SPICE circuit used for these probe heads:

- N2838A 25 GHz PC Board ZIF Tip (with N5439A ZIF Probe Head)
- MX0109A 26 GHz Extreme Temperature Solder-In Probe Head
- N2836A 26 GHz Solder-In Probe Head

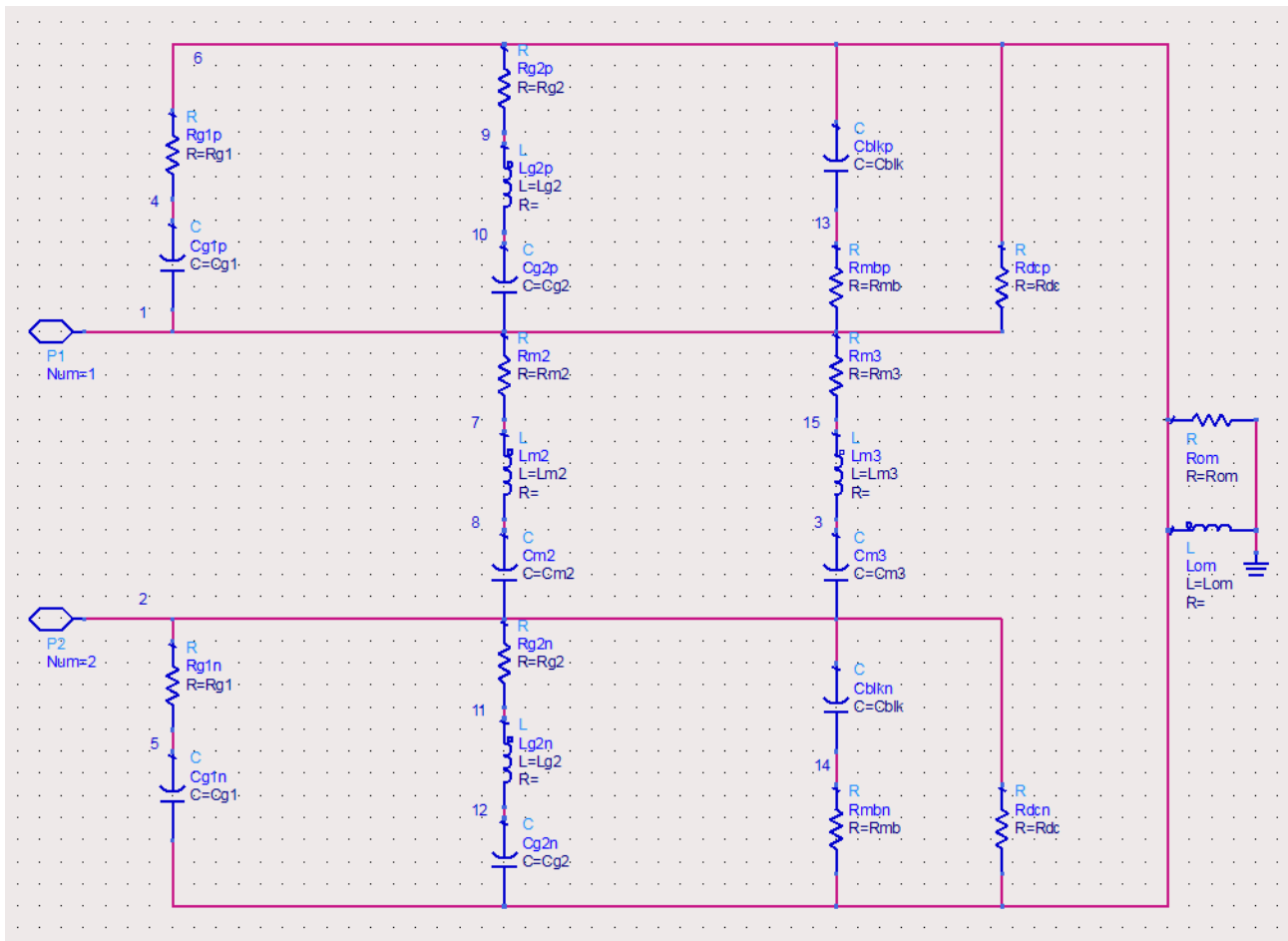

Figure 74 SPICE circuit to use for N2838A, MX0109A, and N2836A probe heads

The input impedance is only a function of the probe head; the amplifier input does not significantly affect the input impedance.

NOTE

You'll find the following SPICE data on the documentation CD that was shipped with your probe. Copying this data from the CD is the simplest most reliable method to get the data.

N2838A PC Board ZIF Tip, N5439A ZIF Probe Head

For matching between the modeled and measured input impedances, refer to **"N2838A/N5439A 25 GHz PCB ZIF Tip/Head (with N2803A)"** on page 112.

```
.subckt N2838A_N5439A_PcbZif 1 2
Cblkp 6 13 100n
Cblkn 2 14 100n
Cg1p 1 4 26.1f
Cg1n 5 6 26.1f
Cg2p 1 10 128.4f
Cg2n 12 6 128.4f
Cm2 2 8 3.04f
Cm3 2 3 7.05f
Rg1p 4 6 67.8
Rg1n 2 5 67.8
Rg2p 9 6 126.2
Rg2n 2 11 126.2
Rm2 1 7 225.9
Rm3 1 15 71.5
Rmbp 1 13 500
Rmbn 14 6 500
Rdcp 1 6 50k
Rdcn 2 6 50k
Rom 6 0 110
Lom 6 0 30u
Lg2p 9 10 1.21n
Lg2n 11 12 1.21n
Lm2 7 8 15.3n
Lm3 3 15 5.76n
.ends
```

MX0109A and N2836A Solder-In Probe Heads

For matching between the modeled and measured input impedances, refer to **“MX0109A and N2836A 26 GHz Solder-In Probe Heads (with N2803A)”** on page 109.

```
.subckt N2836A_SldrIn 1 2
Cblkp 6 13 100n
Cblkn 2 14 100n
Cg1p 1 4 20.7f
Cg1n 5 6 20.7f
Cg2p 1 10 152.2f
Cg2n 12 6 152.2f
Cm2 2 8 4.12f
Cm3 2 3 6.46f
Rg1p 4 6 52.4
Rg1n 2 5 52.4
Rg2p 9 6 142
Rg2n 2 11 142
Rm2 1 7 172.4
Rm3 1 15 67.9
Rmbp 1 13 500
Rmbn 14 6 500
Rdcp 1 6 50k
Rdcn 2 6 50k
Rom 6 0 110
Lom 6 0 30u
Lg2p 9 10 1.12n
Lg2n 11 12 1.12n
Lm2 7 8 11.2n
Lm3 3 15 5.90n
.ends
```

Simplified InfiniiMax III Schematic

NOTE

Do not use this simplified schematic as a SPICE model.

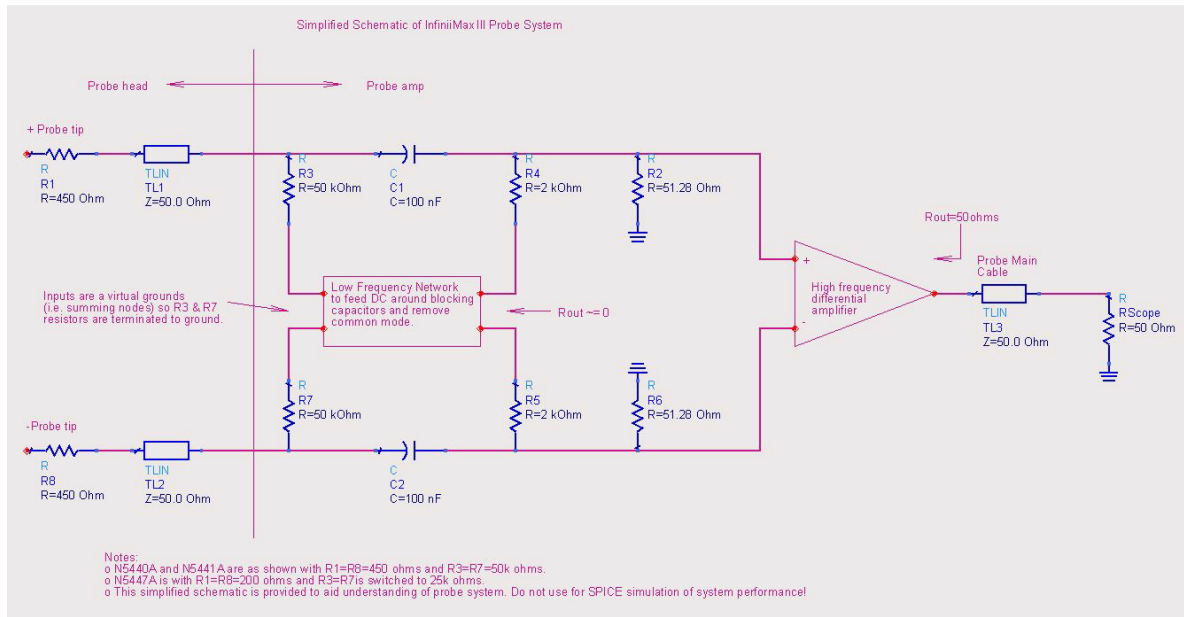

Figure 75 InfiniiMax III Simplified Schematic

Index

Symbols

±4V input connector, 6

Numerics

1143A power supply, 12
86100D DCA-X sampling
oscilloscope, 12

A

accessories
static-safe, 15
AutoProbe III, 9
AutoProbe III interface, 13

B

bandwidth upgrade
N5446A-001 16 GHz to 20 GHz, 8
N5446A-002 20 GHz to 25 GHz, 8
N5446A-003 25 GHz to 30 GHz, 8
N5446A-004 16 GHz to 25 GHz, 8
N5446A-005 16 GHz to 30 GHz, 8
N5446A-006 20 GHz to 30 GHz, 8
bandwidth upgrades, 8
Browser, 26
browser
mounting Holes, 26
tips, 28

C

Calibration, 75
Channel Connection, 7
Characteristics, 63
clutch, 7
Color-coded rings, 7
Conductive table-mat, 15
connecting, probe, 16

D

Deskew Procedure, 75
dimensions, 68

E

Electrostatic discharge, 14
ESD, 14
ESD wrist strap, 14
extreme temperature, 43
Extreme Temperature Extension
Cable, 11, 45, 63
extreme temperature extension
cable, 43

F

Family Diagram, 10

G

ground socket, 15

I

InfiniiMode, 39
isolation, 15

L

LED, 7
headlights, 24
Light button, 7
low temperature hot glue, 54

M

Menu button, 6
MX0109A, 11, 39, 43
MX0109A characteristics, 67
MX0109A dimensions, 68
MX0109A resistor tips, 56
MX0109A spice model, 142

N

N2787A 3D probe positioner, 28
N2800A 16 GHz probe amplifier, 6
N2801A 20 GHz probe amplifier, 6
N2802A 25 GHz probe amplifier, 6
N2803A 30 GHz probe amplifier, 6
N2835A, 51
N2836-68701 replacement axial
resistor kit, 56
N2836A, 39
N2838A dimensions, 69
N2848A dimensions, 70
N2848A QuickTip probe head, 29
N2849A QuickTip, 29
N2852A, 9, 13
N5440A dimensions, 71
N5441A dimensions, 71
N5441A solder-in probe head, 45
N5443A calibration/deskew
fixture, 75
N5444-61601 cable, 48
N5444A SMA probe head, 48
N5445A differential browser probe
head, 24
N5447A ceramic high sensitivity ZIF
tip, 7
N5448B 2.92 mm head flex cables, 48
N5450B, 43
N5450B extreme temperature
extension cable, 11, 45, 63
N5477A sampling scope adapter, 7,
12

O

oscilloscope, 17
oscilloscope channel, 17

P

performance
plots, 107
test record, 105
verification, 83
probe
connecting, 16
probe head dimensions, 68
Proper Handling Techniques, 14
putty, 53

Q

QuickTip probe head, 29

R

resistor
dimensions, 59

S

sampling oscilloscope, 12
adapter, 7, 12
Schematic, 145
Sensitivity, 7
Sensitivity indicator, 7
SMA probe head, 48
solder-in probe head, 39, 45
Specifications, 63
SPICE Models, 136, 142
static-safe accessories, 15
strain relief
tips, 54

T

Tack-putty, 53

U

UXR-series, 9

W

wrist-strap, 15

Z

ZIF Probe Head
connecting, 36
ZIF tip, 7

