

N7020A & N7024A Power Rail Probes

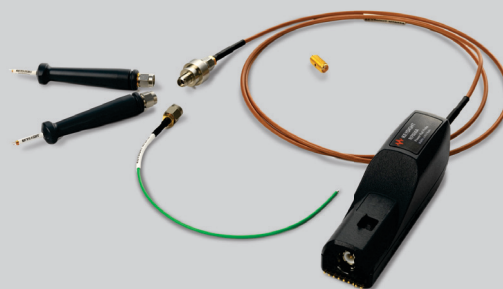

Notices

© Keysight Technologies 2014-2024

No part of this manual may be reproduced in any form or by any means (including electronic storage and retrieval or translation into a foreign language) without prior agreement and written consent from Keysight Technologies, Inc. as governed by United States and international copyright laws.

Manual Part Number

N7020-97005

Edition

Thirteenth edition, June 2024

Published by:

Keysight Technologies
1400 Fountaingrove Parkway
Santa Rosa, CA, 95403

Warranty

The material contained in this document is provided "as is," and is subject to being changed, without notice, in future editions. Further, to the maximum extent permitted by applicable law, Keysight disclaims all warranties, either express or implied, with regard to this manual and any information contained herein, including but not limited to the implied warranties of merchantability and fitness for a particular purpose. Keysight shall not be liable for errors or for incidental or consequential damages in connection with the furnishing, use, or performance of this document or of any information contained herein. Should Keysight and the user have a separate written agreement with warranty terms covering the material in this document that conflict with these terms, the warranty terms in the separate agreement shall control.

Technology Licenses

The hardware and/or software described in this document are furnished under a license and may be used or copied only in accordance with the terms of such license.

U.S. Government Rights

The Software is "commercial computer software," as defined by Federal Acquisition Regulation ("FAR") 2.101. Pursuant to FAR 12.212 and 27.405-3 and Department of Defense FAR Supplement ("DFARS") 227.7202, the U.S. government acquires commercial computer software under the same terms by which the software is customarily provided to the public. Accordingly, Keysight provides the Software to U.S. government customers under its standard commercial license, which is embodied in its End User License Agreement (EULA), a copy of which can be found at <http://www.keysight.com/find/sweula>. The license set forth in the EULA represents the exclusive authority by which the U.S. government may use, modify, distribute, or disclose the Software. The EULA and the license set forth therein, does not require or permit, among other things, that Keysight: (1) Furnish technical information related to commercial computer software or commercial computer software documentation that is not customarily provided to the public; or (2) Relinquish to, or otherwise provide, the government rights in excess of these rights customarily provided to the public to use, modify, reproduce, release, perform, display, or disclose commercial computer software or commercial computer software documentation. No additional government requirements beyond those set forth in the EULA shall apply, except to the extent that those terms, rights, or licenses are explicitly required from all providers of commercial computer software pursuant to the FAR and the DFARS and are set forth specifically in writing elsewhere in the EULA. Keysight shall be under no obligation to update, revise or otherwise modify the Software. With respect

to any technical data as defined by FAR 2.101, pursuant to FAR 12.211 and 27.404.2 and DFARS 227.7102, the U.S. government acquires no greater than Limited Rights as defined in FAR 27.401 or DFAR 227.7103-5 (c), as applicable in any technical data. 52.227-14 (June 1987) or DFAR 252.227-7015 (b)(2) (November 1995), as applicable in any technical data.

Safety Notices

CAUTION

A **CAUTION** notice denotes a hazard. It calls attention to an operating procedure, practice, or the like that, if not correctly performed or adhered to, could result in damage to the product or loss of important data. Do not proceed beyond a **CAUTION** notice until the indicated conditions are fully understood and met.

WARNING

A **WARNING** notice denotes a hazard. It calls attention to an operating procedure, practice, or the like that, if not correctly performed or adhered to, could result in personal injury or death. Do not proceed beyond a **WARNING** notice until the indicated conditions are fully understood and met.

Contents

- 1 N7020A / N7024A Probes - Overview / 5**
 - Introduction / 6
 - Probe Accessories / 9
 - Oscilloscope Compatibility / 16

- 2 General Information / 17**
 - Inspecting the Probe / 18
 - Handling the Probe / 19
 - Cleaning the Probe / 20
 - Returning the Probe for Service / 21
 - Contacting Keysight Technologies / 22

- 3 Specifications and Characteristics / 23**
 - N7020A Probe Specifications and Characteristics / 24
 - N7024A Probe Specifications and Characteristics / 28

- 4 Safety and Regulatory Information / 33**

- 5 Using the Power Rail Probe / 37**
 - Requirements for Optimum Probe Performance / 39
 - Connecting to the DUT / 42
 - Replacing N7023A Probe Browser Tips / 50
 - Avoiding Costly Repairs / 51
 - Common Types of Power Integrity Measurements / 53

- 6 Calibrating / 55**
 - N7020A / N7024A Probe's DC Attenuation/Offset Calibration Using N7022A Main Cable / 56

Contents

N7020A / N7024A Probe's DC Attenuation/Offset Calibration Using
N7023A Probe Browser / 57

7 Performance Plots / 59

N7020A Performance Plots / 60

N7020A Input Impedance Equivalent Model / 64

N7024A Performance Plots / 66

N7024A Input Impedance Plots / 68

8 Performance Verification / 75

DC Input Resistance Performance Verification / 76

Bandwidth Performance Verification for N7024A Probe / 79

Index

1 N7020A / N7024A Probes – Overview

Introduction	6
Probe Accessories	9
Oscilloscope Compatibility	16

Introduction

In this guide, the following two probes in the power rail probing category are described.

- N7020A 2 GHz Power Rail Probe
- N7024A 6 GHz Power Rail Probe



These probes are designed for power integrity measurements such as Periodic and Random Disturbances (PARD), static and dynamic load response, and programmable power-rail response.

These probes have an output connector with the Keysight AutoProbe 1 interface that allows these probes to connect directly to a compatible Keysight oscilloscope (see [page 16](#)). The oscilloscope's AutoProbe interface provides the probe power, probe offset, and auto configuration of probe type and attenuation setting on connection.

A variety of accessories are shipped with these probes to suit various DUT connection scenarios and to make the connection to DUT possible in the most difficult to reach situations as well (see [page 42](#)).

These probes provide the following advantages:

- Low noise due to a low attenuation ratio and 50Ω output. See [Figure 1](#) and [Figure 2](#) on page 8.
- A large probe offset range. The offset allows small signals (~ 1 mV), that exist on top of a DC supply, to be centered on an oscilloscope screen for maximum vertical sensitivity.
- Low DC loading due to a $50\text{ k}\Omega$ input impedance at DC.

- Large active signal range in addition to the offset range

NOTE

While the N7020A and N7024A probes have a number of features in common, the N7024A probe is an extension to the capabilities and performance of the N7020A probe. When compared to the N7020A probe, the N7024A probe provides enhanced features such as:

- > higher bandwidth (upto 6 GHz)
 - > compatibility with high-end Keysight oscilloscopes (V-series and Z-series)
 - > improved usability and browsing capabilities
 - > unique s parameters stored in each N7024A probe for maximum accuracy
-

CAUTION

Before using these probes, refer to **"Safety and Regulatory Information"** on page 33. Handle the probes with care and refer to the safety notices in this manual. Avoid any mechanical shocks to these products to guarantee accurate performance and protection.

1 N7020A / N7024A Probes - Overview

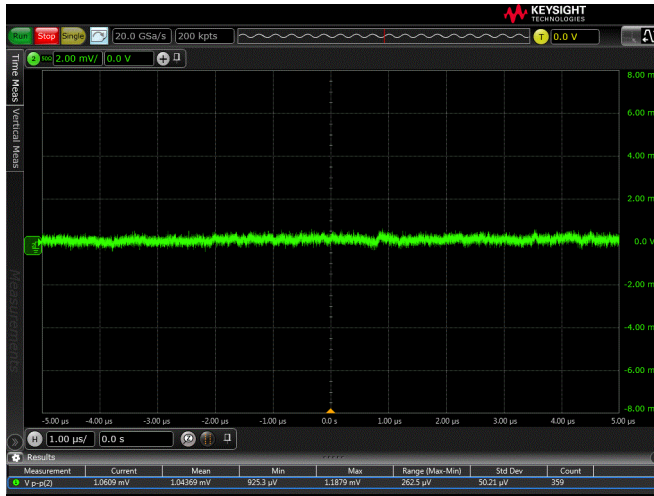

Figure 1 Example of Measured Mean Noise at 2 GHz BW: 1.04369 mV_{p-p}

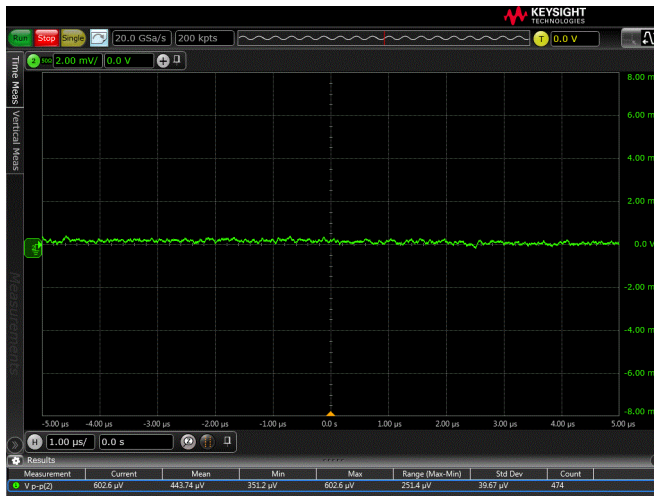

Figure 2 Example of Measured Mean Noise at 20 MHz BW: 443.74 mV_{p-p}

Probe Accessories

Standard Accessories

The N7020A and N7024A probes are shipped with the accessories shown in [Figure 3](#) and [Figure 4](#) respectively. These standard accessories are described in [Table 1](#).

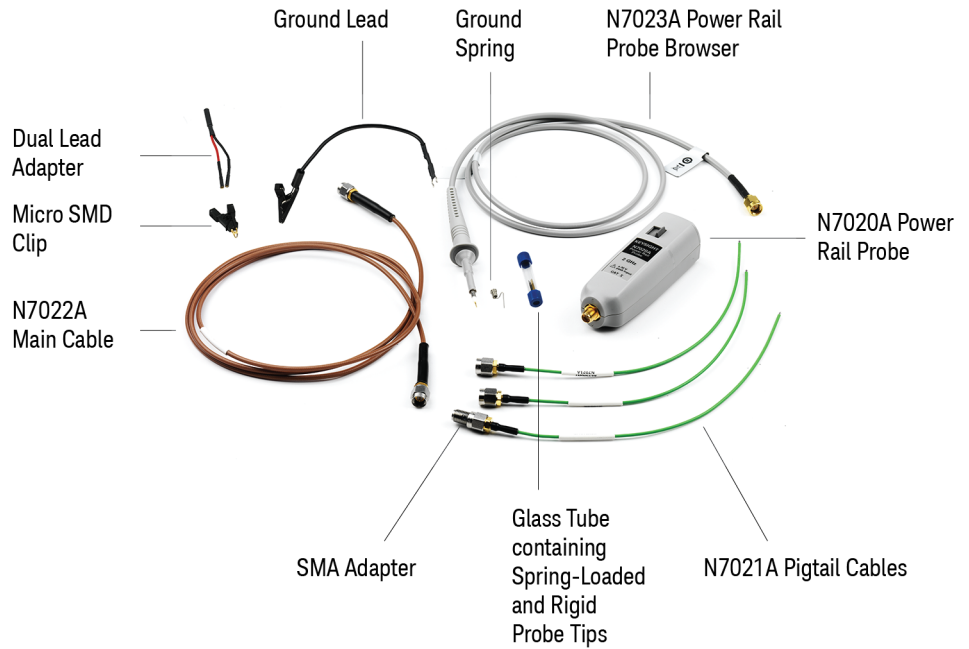

Figure 3 N7020A Probe with Standard Accessories

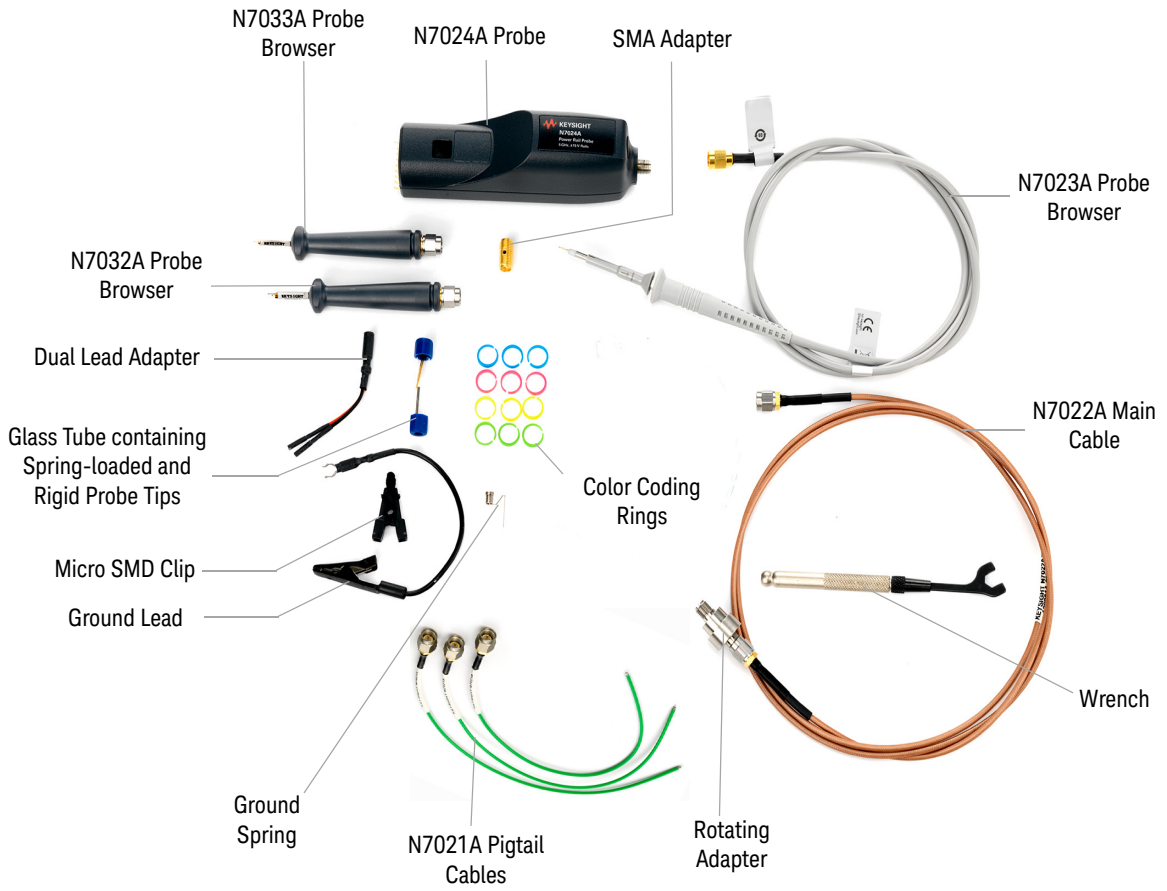

Figure 4 N7024A Probe with Standard Accessories

Table 1 Standard Accessories

Accessories	Quantity Supplied	Description	Shipped with	
			N7020A Probe	N7024A Probe
N7021A Pigtail Cables	3	Coaxial cables designed to be soldered onto the DUT and connected to the probe via the main cable. Refer to the topic "Using the N7021A Pigtail Cable and N7022A Main Cable" on page 44 to know more.	?	?
N7022A Main Cable	1	Coaxial cable that you can use to establish connectivity between the probe and DUT in multiple ways such as direct connection to DUT, connection via pigtail cables, or connection via N7033A / N7034A probe browsers.	?	?
SMA Adapter	1	Used to connect the main cable to: - the pigtail cable. - the N7032A / N7033A probe browser.	?	?
Rotating Adapter	1	Used to connect the main cable to: - the pigtail cable. - the N7032A / N7033A probe browser.		?
Wrench	1	Used to effectively grip and tighten the smaller side of the rotating adapter.		?
N7032A Power Rail Probe Browser	1	Browser based on .086" semi-rigid coax that has an approximate fixed span of .055" for probing 0603 and 0805 SMT parts. NOTE: Though this browser is not shipped as a standard accessory with the N7020A probe, you can order it separately for use with the N7020A probe.		?
N7033A Power Rail Probe Browser	1	Browser based on .047" semi-rigid coax that has an approximate fixed span of .035" for probing 0201 and 0402 SMT parts. NOTE: Though this browser is not shipped as a standard accessory with the N7020A probe, you can order it separately for use with the N7020A probe.		?

Table 1 Standard Accessories

Accessories	Quantity Supplied	Description	Shipped with	
			N7020A Probe	N7024A Probe
N7023A Power Rail Probe Browser	1	Provides a convenient way to probe the power rails with a number of accessories available for connection to DUT. The trade-off for this convenience is the lower signal fidelity than the N7021A pigtail cables or the N7022A main cable or other two supported browsers. Mechanically, this browser is similar to a traditional passive probe and is used in the same manner.	?	?
N7023A Browser Accessories (N7023A browser is shipped with the following accessories.)				
Ground Spring 2.5 mm	1	Provides the highest performance connection for the N7023A probe browser.	?	?
Ground Lead 15 cm	1	Used to reach grounding locations that are farther away from the probing location than can be reached by the ground spring. However, the longer lead means it has a larger inductance in the ground return path which corresponds to a lower performance than using the ground spring.	?	?
Spring-loaded Probe Tips	3	Allows you to probe signals with less susceptibility to vibration or movement than traditional rigid tips. The spring loaded tips work when they are either partially or fully compressed and are protected against over compression damage. Note: One spring-loaded tip is pre-installed by Keysight into the N7023A browser. These tips are replaceable. To know how to replace these tips, refer to "Replacing N7023A Probe Browser Tips" on page 50.	?	?
Rigid Probe Tips	2	Replaceable probe tips. To know how to replace these tips, refer to "Replacing N7023A Probe Browser Tips" on page 50.	?	?

Table 1 Standard Accessories

Accessories	Quantity Supplied	Description	Shipped with	
			N7020A Probe	N7024A Probe
Dual Lead Adapter	1	Allows you to easily connect the N7023A browser to the popular 0.1" pin headers with 0.025" square pins. This dual lead adapter has no shorting hazards since all external metal surfaces are insulated.	?	?
Micro SMD Clip (Surface Mount Grabber)	1	Provides fast and convenient hands-free probing of surface mount capacitors. The Micro SMD clip is used in conjunction with the dual lead adapter. It is a best practice to twist the leads off the dual lead adapter to reduce coupling of external noise into the probe.	?	?
Protection Cap 2.5 mm	1	Provides a protective cover to the browser when not in use.	?	?
Color Coding Rings	3x4 colors	Used to keep track of which probe is connected to which channel input on your oscilloscope. Place one ring on the probe cable near the oscilloscope input and place another ring of the same color near the probe head. This ensures that you can pick up a probe and immediately know which channel it is connected to without having to track the cable back to the oscilloscope channel input.	?	?

Optional Orderable Accessories

Besides the standard accessories that are shipped with the probes, a number of optional accessories are also available that you can order separately. These optional accessories are shown in this picture and briefly described in [Table 2](#) on page 15.

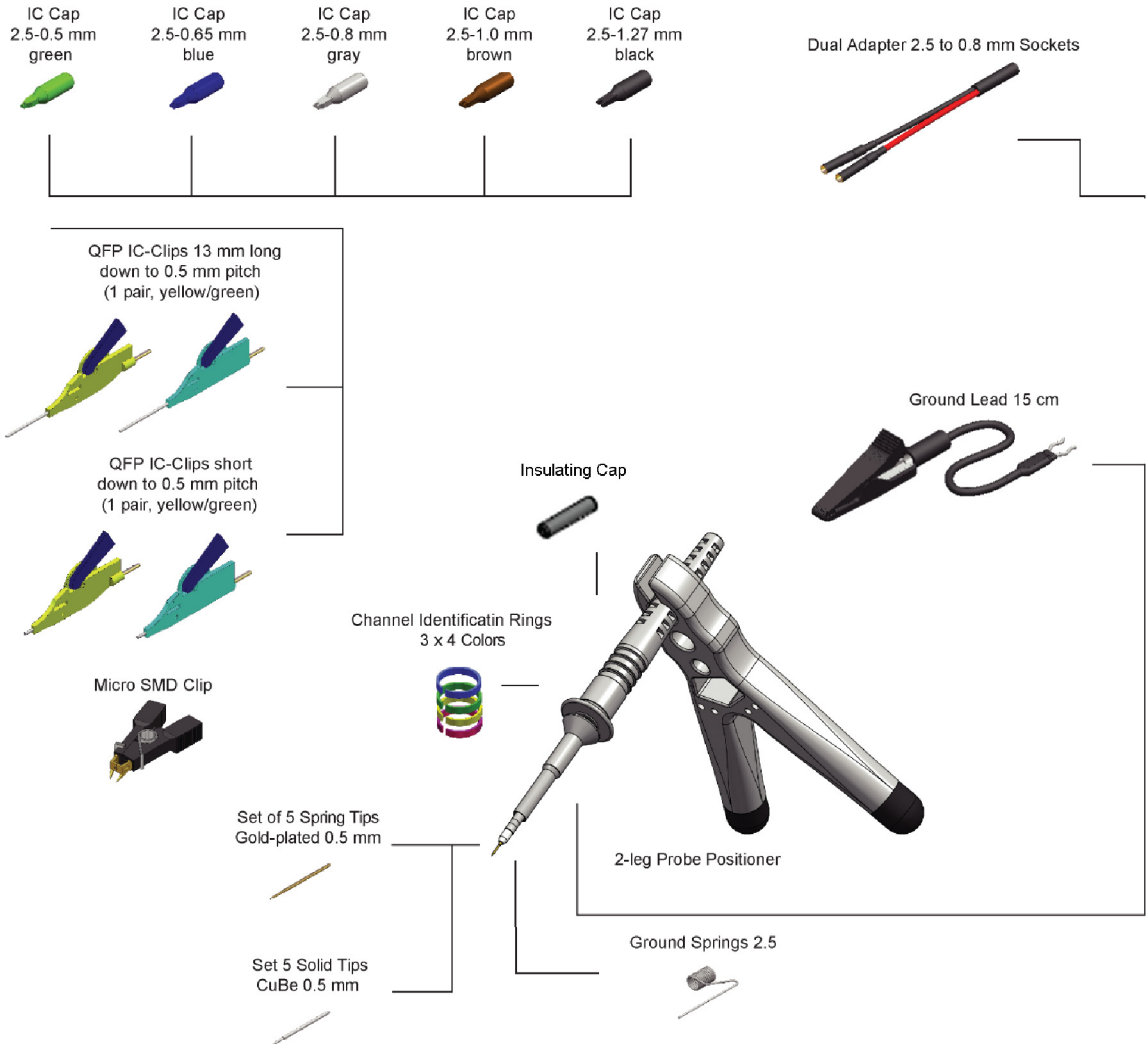

Table 2 Orderable Accessories

Optional Accessory	Quantity	Accessory P/N	Keysight Product Number
IC Cap 2.5 - 0.5 mm green	3	0960-2983	-
IC Cap 2.5 - 0.65 mm blue	3	0960-2984	-
IC Cap 2.5 - 0.8 mm gray	3	0960-2988	-
IC Cap 2.5 - 1.0 mm brown	3	0960-2989	-
IC Cap 2.5 - 1.27 mm black	3	0960-2986	-
Insulating Cap 2.5 mm	1	0960-2985	-
Ground Spring 2.5 mm	3	0960-2980	N4838A
Set of 5 Spring Tips Gold-plated 0.5 mm	1	0960-2981	-
Set of 5 Solid tips CuBe 0.5 mm	1	0960-2979	-
Dual adapter 2.5 to 0.8 mm sockets	1	0960-2898	N4836A
QFP IC-Clips 13 mm long down to 0.5 mm pitch (1 pair yellow/green)	2	0960-2992	-
QFP IC-Clips short down to 0.5 mm pitch (1 pair yellow/green)	2	0960-2995	-
Ground Lead 15 cm	1	0960-2906	N4837A
2-leg Probe Positioner	1	N2786-60001	N2786A
Micro SMD Clip	1	1400-3652	-

Oscilloscope Compatibility

NOTE

The N7020A and N7024A probes are designed for Keysight oscilloscopes with 50Ω AutoProbe-interface channel inputs.

Table 3 Compatible Oscilloscopes for the N7020A and N7024A Probes

Compatible Oscilloscopes for the N7020A Probe		Compatible Oscilloscopes for the N7024A Probe	
Oscilloscopes	Required Firmware Version	Infiniium Oscilloscopes	Required Firmware Version
EXR-Series	11.06.00401 or higher	EXR-Series	11.06.00401 or higher
MXR-Series	11.00 or higher	MXR-Series	11.00 or higher
S-Series	≥ 5.20	S-Series	≥ 06.20.00803
9000 Series	≥ 5.20	V-Series (with N5442A adapter)	
6000 X-Series	≥ 6.10	Z-Series (with N5442A adapter)	
4000 X-Series	≥ 4.00	90000X/Q-Series	
3000T X-Series	≥ 4.00	UXR-Series 3.5 mm models (with N5442A adapter)	
3000A-X-Series	≥ 2.39	UXR-Series 1 and 1.85 mm models (with N5442A + N2852A adapters)	≥ 11.15.00001
		9000	≥ 6.50.00906
		90000A	

Is Your Oscilloscope Software Up-to-Date? Keysight periodically releases software updates to support your probe, fix known defects, and incorporate product enhancements. To download the latest firmware, go to www.keysight.com and search for your oscilloscope's topic. Click on the "Drivers, Firmware & Software" tab.

2 General Information

Inspecting the Probe	18
Handling the Probe	19
Cleaning the Probe	20
Returning the Probe for Service	21
Contacting Keysight Technologies	22

Inspecting the Probe

- Inspect the shipping container for damage.

Keep the damaged shipping container or cushioning material until the contents of the shipment have been checked for completeness and the probe has been checked mechanically and electrically.

- Check the accessories.
- If the contents are incomplete or damaged, notify your Keysight Technologies Sales Office.
- Inspect the probe. If there is mechanical damage or defect, or if the probe does not operate properly or pass calibration tests, notify your Keysight Technologies Sales Office.

If the shipping container is damaged, or the cushioning materials show signs of stress, notify the carrier as well as your Keysight Technologies Sales Office. Keep the shipping materials for the carrier's inspection. The Keysight Technologies office will arrange for repair or replacement at Keysight Technologies' option without waiting for claim settlement.

WARNING

Must be Grounded. Before making connections to the input leads of this probe, ensure that the probe's output connector is attached to the channel input of the oscilloscope and the oscilloscope is properly grounded.

CAUTION

Use only the accessories supplied with this probe or in the accessory kit.

Handling the Probe

Handle the probe with care to avoid injury, especially when it is fitted with the extra thin and sharp spring contact tip.

CAUTION

The browser cable is a sensitive part of the N7023A power rail probe browser and, therefore, you should be careful not to damage it through excessive bending or pulling. You should also avoid any mechanical shocks to this product in order to guarantee accurate performance and protection.

WARNING

Periodically inspect the probe wires and cables to check for any damage. The probe must NOT BE USED if there are any signs of damage.

CAUTION

If the N7022A main cable is damaged, it may cause the N7024A probe to not meet its warranted bandwidth specification of 6 GHz. It is recommended to verify the cable using the procedure described in **"To verify if the N7022A main cable is damaged"** on page 85.

Cleaning the Probe

If the probe requires cleaning:

- 1** Disconnect the probe from the oscilloscope, external power supply, and any circuit under test.
- 2** Gently clean the probe with a soft cloth dampened with a mild soap and water solution.
- 3** Wipe with clean water to remove the detergent and then dry thoroughly with a clean cloth.
- 4** Make sure that the probe is completely dry before reconnecting it to an oscilloscope.

Returning the Probe for Service

If the probe is found to be defective we recommend sending it to an authorized service center for all repair and calibration needs. Perform the following steps before shipping the probe back to Keysight Technologies for service.

- 1 Contact your nearest Keysight sales office for information on obtaining an RMA number and return address.
- 2 Write the following information on a tag and attach it to the malfunctioning equipment.
 - Name and address of owner
 - Product model number (for example, N7024A)
 - Product Serial Number (for example, MYXXXXXXXX)
 - Description of failure or service required.

NOTE

Include probing and browsing heads if you feel the probe is not meeting performance specifications or a yearly calibration is requested.

- 3 Protect the probe by wrapping in plastic or heavy paper.
- 4 Pack the probe in the original carrying case or if not available use bubble wrap or packing peanuts.
- 5 Place securely in sealed shipping container and mark container as "FRAGILE".

NOTE

If any correspondence is required, refer to the product by serial number and model number.

Contacting Keysight Technologies

For technical assistance, contact your local Keysight Call Center.

- In the Americas, call 1 (800) 829-4444
- In other regions, visit <http://www.keysight.com/find/assist>
- Before returning an instrument for service, you must first call the Call Center at 1 (800) 829-4444.

3 Specifications and Characteristics

N7020A Probe Specifications and Characteristics **24**

N7024A Probe Specifications and Characteristics **28**

The tables in this chapter list the specifications and characteristics for the N7020A and N7024A probes.

NOTE

All entries included in this chapter are characteristics unless otherwise noted.

Input Impedance DC is the only warranted specification for the N7020A probe.

Bandwidth (for the probe) and Input Impedance DC are the only warranted specifications for the N7024A probe.

N7020A Probe Specifications and Characteristics

Table 4 N7020A Environmental Specifications

Attribute	Specification	Specification
	With N7021A Pigtail Cable / N7022A Main Cable	With N7023A / N7032A / N7033A Browser
Use	For indoor use only	
Temperature	Operating: -10 °C to +55 °C (probe pod) Non-operating: -40 °C to +70 °C (probe pod)	
	Operating: -40 °C to +85 °C (main cable/pigtail cable) Non-operating: -40 °C to +85 °C (main cable/pigtail cable)	Operating: -10 °C to +55 °C (browser) Non-operating: -40 °C to +70 °C (browser)
Altitude	Operating: 3,000 m (9,842 feet) Non-operating: 15,300 m (50,196 feet)	
	Operating: 25 – 85% room humidity Non-operating: 25 – 85% room humidity	Operating: 80% room humidity for temperatures up to 31 °C, decreasing linearly to 40% at 50 °C Non-operating: 95% room humidity for temperatures up to 40 °C
Pollution Degree	Pollution Degree 2	

NOTE

A few electrical specifications and characteristics of the probe vary based on the connection mechanism used to connect the probe to DUT. This variation is listed in the table below. To know about these connection mechanisms, see [“Connecting to the DUT”](#) on page 42.

Table 5 N7020A Electrical Characteristics and Specifications

Attribute	Characteristics (based on probe's connection configuration)				
	With N7022A Main Cable	With N7021A Pigtail Cable & N7022A Main Cable	With N7023A Browser	With N7032A Browser & N7022A Main Cable	With N7033A Browser & N7022A Main Cable
Probe Bandwidth (-3 dB)	2 GHz	2 GHz	350 MHz (using the included ground spring)	2 GHz	2 GHz
Maximum Input Voltage (non-destructive)			±30V peak input (mains isolated)		
Attenuation Ratio			1.1:1		
Offset Range			± 24V		
Input Impedance at DC *			50 kΩ ±2%		
Active Signal Range			± 850 mV (about offset voltage)		
Probe Noise (at 2 GHz)			10% increase in the noise of the connected oscilloscope		
Output Termination			50 Ω scope input		
Probe Type			Single Ended		

* Warranted specification. All other characteristics are typical.

Table 6 Mechanical Characteristics of N7020A Probe and Browsers

Description	N7020A Probe	N7023A Browser	N7032A Browser	N7033A Browser
Weight	50 g	26 g	10 g	10 g
Dimensions	See Figure 5 on page 27 for dimensions.			

Table 7 Safety Specifications of N7020A Power Rail Probe

Specification
IEC61010-031

For a description of safety markings and symbols on the probe, refer to the chapter "[Safety and Regulatory Information](#)" on page 33.

N7020A Probe, Browsers, and Cables Dimensions

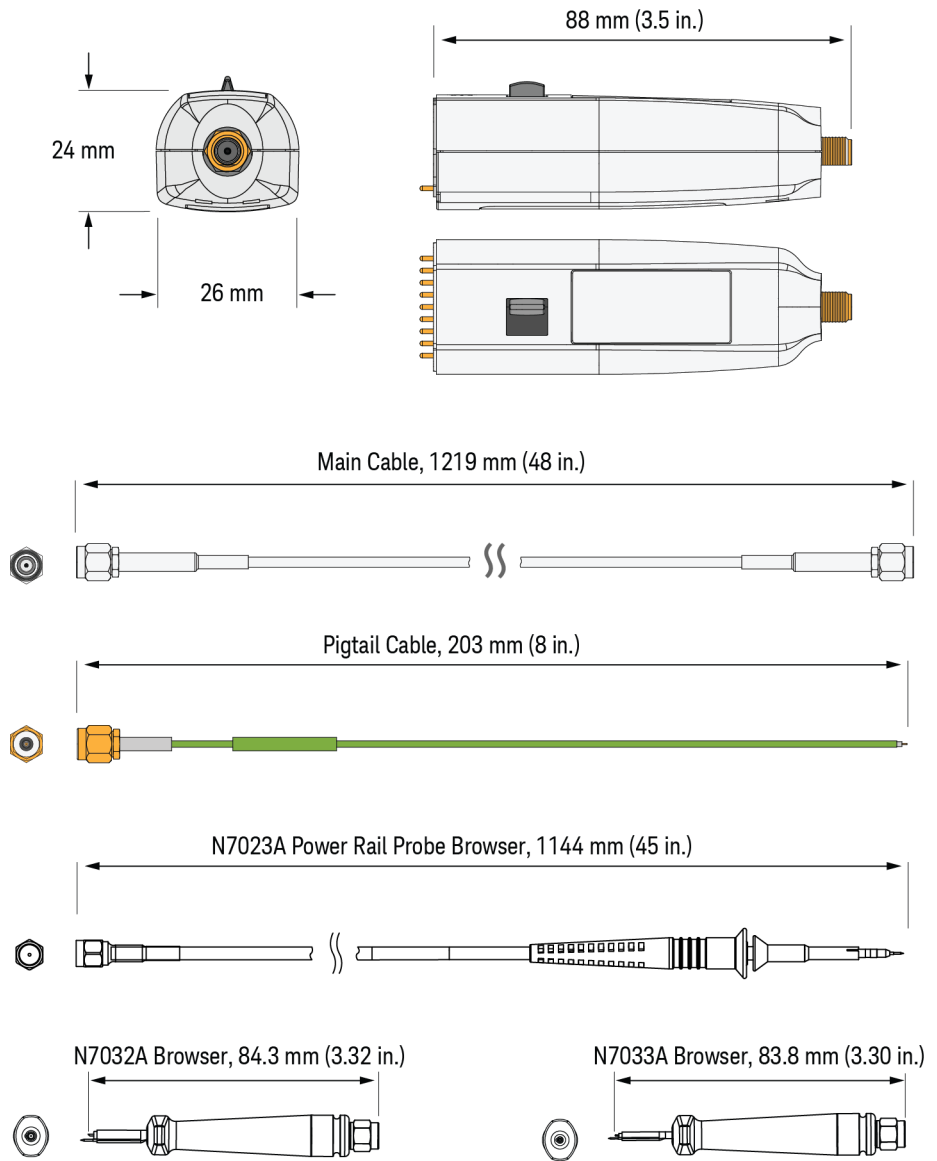

Figure 5 N7020A Probe, Browsers, and Accessory Cables Dimensions

N7024A Probe Specifications and Characteristics

Table 8 N7024A Environmental Specifications

Attribute	Specification With N7022A Main Cable / N7021A Pigtail Cable	Specification With N7023A / N7032A / N7033A Browser
Use	For indoor use only	
Temperature	Operating: -10 °C to +55 °C (probe pod) Non-operating: -40 °C to +70 °C (probe pod)	
	Operating: -40 °C to +85 °C (main cable/pigtail cable) Non-operating: -40 °C to +85 °C (main cable/pigtail cable)	Operating: -10 °C to +55 °C (browser) Non-operating: -40 °C to +70 °C (browser)
Altitude	Operating: 4600 m (15,092 feet) Non-operating: 15,300 m (50,196 feet)	Operating: 4600 m (15,092 feet) Non-operating: 15,300 m (50,196 feet)
Humidity	Operating: 25 – 85% room humidity Non-operating: 25 – 85% room humidity	Operating: 80% room humidity for temperatures up to 31 °C, decreasing linearly to 40% at 50 °C Non-operating: 95% room humidity for temperatures up to 40 °C
Pollution Degree	Pollution Degree 2	

NOTE

A few electrical specifications and characteristics of the probe vary based on the connection mechanism used to connect the probe to DUT. This variation is listed in the table below. To know about these connection mechanisms, refer "[Connecting to the DUT](#)" on page 42.

Table 9 N7024A Probe Electrical Characteristics and Specifications

Attribute	Characteristics (based on probe's connection configuration)					
	For the N7024A Probe Only	Probe with N7022A Main Cable	Probe with N7021A Pigtail Cable & N7022A Main Cable	Probe with N7023A Browser	Probe with N7032A Browser & N7022A Main Cable	Probe with N7033A Browser & N7022A Main Cable
Probe Bandwidth (-3 dB)	6 GHz *	6 GHz	5 GHz	350 MHz	4 GHz	5 GHz
Maximum Input Voltage (non-destructive)	±15V peak input (mains isolated)					
Attenuation Ratio	1.3:1					
Risetime (10 to 90%) <i>Calculated as: tr = .435/bandwidth</i>		73pS	87pS	1.24nS	109pS	87pS
Risetime (20 to 80%) <i>Calculated as: tr = .676 * 10/90 tr</i>		49pS	59pS	.84nS	74pS	59pS
Offset Range	± 15.25V					
Input Impedance at DC *	50 kΩ ±2%					
Active Signal Range	± .6V (1.2Vpp)					
Probe + Oscilloscope Noise	30% increase in the noise of the connected oscilloscope					
Output Termination	50 Ω scope input					
Probe Type	Single Ended					

* Warranted specification. All other characteristics are typical.

Table 10 Mechanical Characteristics of the N7024A Probe and Browsers

Description	N7024A Probe	N7023A Browser	N7032A Browser	N7033A Browser
Weight	155 g	26 g	10 g	10 g
Dimensions	See Figure 6 on page 31 for dimensions.			

Table 11 Safety Specifications of N7024A Probe

Specification
IEC61010-031

For a description of safety markings and symbols on the probe, refer to the chapter "[Safety and Regulatory Information](#)" on page 33.

N7024A Probe, Cables, and Browsers Dimensions

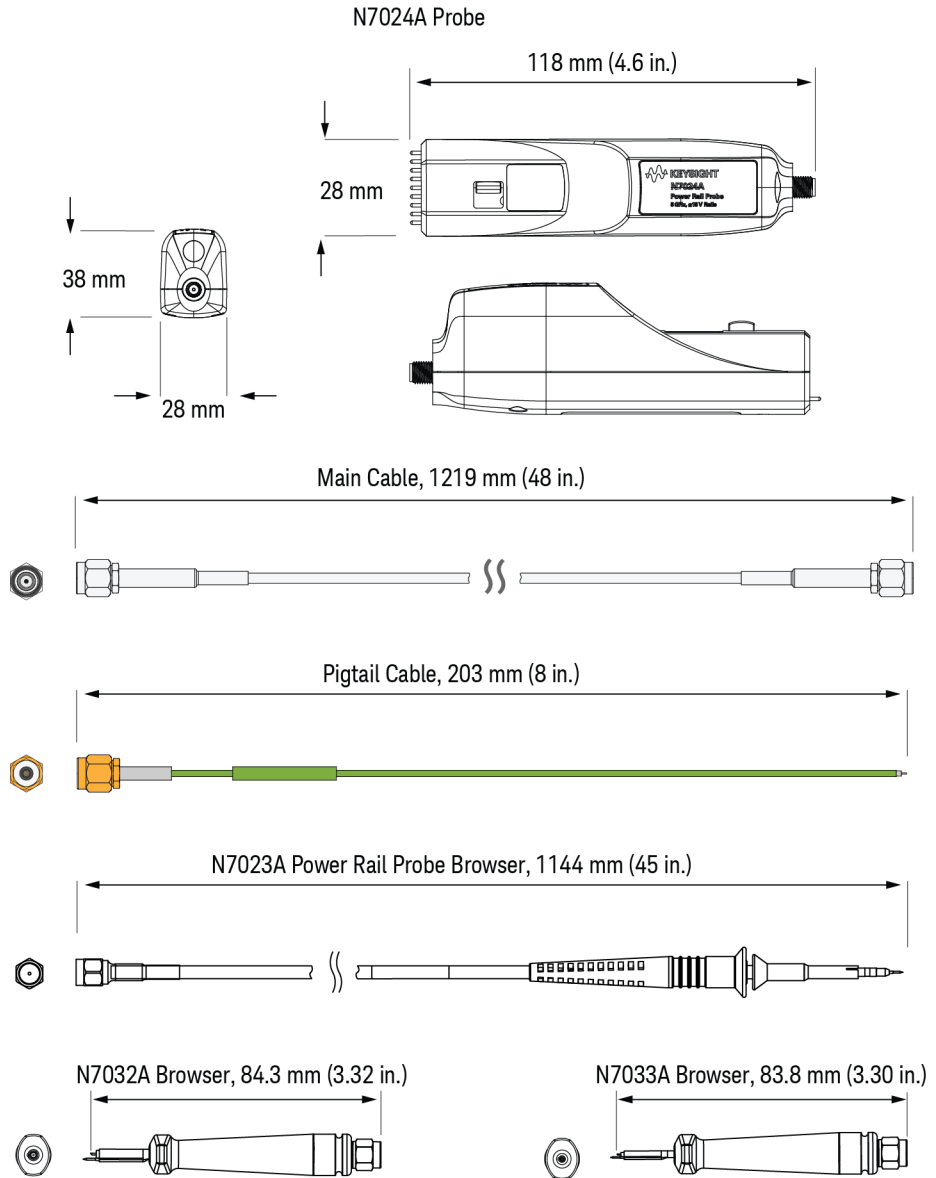

Figure 6 N7024A Probe, Browsers, and Accessory Cables Dimensions

3 Specifications and Characteristics

4 Safety and Regulatory Information

These probes have been designed and tested in accordance with accepted industry standards, and have been supplied in a safe condition.

Throughout this manual and specifically in this chapter, there are warnings, cautions, and notes that must be followed by the user to ensure safe operation and to maintain the product in a safe condition. If the probe is used in a manner not specified by the manufacturer, the protection provided by the equipment may be impaired.



Also, note the external markings on the probe that are described in this document.

WARNING

To avoid personal injury and to prevent fire or damage to this product or products connected to it, review and comply with the following safety precautions. Be aware that if you use this probe assembly in a manner not specified, the protection this product provides may be impaired.



CAUTION

These probes are for use only on circuits that are not directly connected to mains. Do not use the probe for measurements on mains circuits.

WARNING

Use Only Grounded Instruments.

Do not connect the probe's ground lead to a potential other than earth ground. Always make sure the probe and oscilloscope are grounded properly. Before making connections to the input leads of this probe, ensure that the probe's output connector is attached to the channel input of the oscilloscope and the oscilloscope is properly grounded.

WARNING

Connect and Disconnect Properly.

Connect the probe to the oscilloscope and connect the ground lead to earth ground before connecting the probe to the circuit under test. Disconnect the probe input and the probe ground lead from the circuit under test before disconnecting the probe from the oscilloscope.

WARNING

Do Not Operate Without Covers. To avoid electrical shock or fire hazard, do not operate this probe with the covers removed.

WARNING

Avoid Exposed Circuit. To avoid injury, remove jewelry such as rings, watches, and other metallic objects. Do not touch exposed connections and components when power is present.

WARNING

For Indoor Use Only. Do not operate in wet / damp environments to avoid electric shock. Keep product surfaces dry and clean. Do not operate in an explosive environment.

WARNING

Do Not Operate With Suspected Failures. If you suspect there is damage to this probe, have it inspected by a qualified service personnel.

WARNING

Periodically inspect the probe wires and cables to check for any damage. The probe must **NOT BE USED** if there are any signs of damage.

Concerning the Oscilloscope or Voltage Measuring Instrument to Which the Probe is Connected

WARNING

Whenever it is likely that the ground protection is impaired, you must make the instrument inoperative and secure it against any unintended operation.

WARNING

If you energize the instrument by an auto transformer (for voltage reduction or mains isolation), the ground pin of the input connector terminal must be connected to the earth terminal of the power source.





WARNING

Before turning on the instrument, you must connect the protective earth terminal of the instrument to the protective conductor of the (mains) power cord. The mains plug shall only be inserted in a socket outlet provided with a protective earth contact. You must not negate the protective action by using an extension cord (power cable) without a protective conductor (grounding). Grounding one conductor of a two-conductor outlet is not sufficient protection.

WARNING

Capacitors inside the instrument may retain a charge even if the instrument is disconnected from its source of supply.

Instrument Markings and Symbols

Marking	Description
	This symbol indicates the Environmental Protection Use Period (EPUP) for the product's toxic substances for the China RoHS requirements.
	The CE mark is a registered trademark of the European Community.
	The crossed out wheeled bin symbol indicates that separate collection for waste electric and electronic equipment (WEEE) is required, as obligated by the EU DIRECTIVE and other National legislation. Please refer to keysight.com/go/takeback to understand your Trade in options with Keysight in addition to product takeback instructions.
	The product is marked with this symbol when it is necessary for the user to refer to the instructions in the documentation.

4 Safety and Regulatory Information

5 Using the Power Rail Probe

Requirements for Optimum Probe Performance	39
Low Source Impedance Required	39
Minimize Probe Ground Impedance for the Best Signal Fidelity	40
Connecting to the DUT	42
Replacing N7023A Probe Browser Tips	50
Avoiding Costly Repairs	51
Common Types of Power Integrity Measurements	53

This chapter describes requirements for ensuring optimum probe performance, how to connect the probe to the DUT, and how to protect the oscilloscope and probe from damage due to ESD.

CAUTION

Always wear an ESD wrist strap when working with active probes. Not doing so can result in damage to the probe and to the oscilloscope's input channel.

NOTE

If the N7020A input is connected to an S-series oscilloscope at vertical settings at or below 20 mV/div with more than 200 mV of applied offset with no signal on the probe input, the probe output may be indeterminate. Upon zeroing the offset, increasing the vertical setting, or connecting the probe input to a low impedance (power rail), the output will be correctly restored.

NOTE

Connect the N7020A probe to a powered-on oscilloscope for at least 20 minutes before any testing to allow the probe to warm up.

Connect the N7024A probe to an oscilloscope that has been powered-on for at least 20 minutes to allow the oscilloscope to warm up before any testing.

Ensure that the environmental conditions do not exceed the probe's specified limits in [Chapter 3](#), "Specifications and Characteristics".

Requirements for Optimum Probe Performance

Low Source Impedance Required

The N7020A and N7024A are designed explicitly for measuring DC power supplies. In order to maintain a flat frequency response across the probe's bandwidth, the DUT must have extremely low source impedance, like that of a power rail. The probes have a non-flat input impedance that transitions from $50\text{ k}\Omega$ at DC to 50Ω at 1 MHz and above. Therefore, if the DUT impedance is not low, it will divide with the probe's impedance unequally across frequency, causing a non-flat measurement. The recommended DUT impedance should be much less than 1 ohm. At 1 ohm, the DC-to-AC non-flatness is about 2%. Figure 7 shows the non-flatness for DUT impedances of 0Ω , 1Ω , 25Ω , and 50Ω .

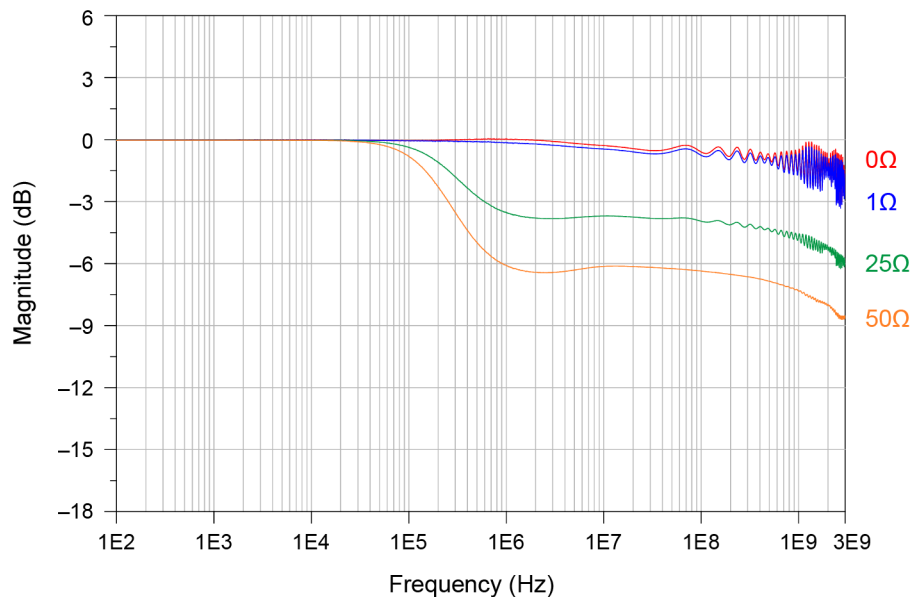

Figure 7 Frequency Response (N7020A Probe with N7022A Main Cable) Versus DUT Impedance

To the DC component of a supply voltage, the probe presents a high impedance and thus low loading (about 50 k Ω). To the AC component of the supply voltage, the probe presents a low 50 Ω impedance. This probe's low input impedance, reduces noise on the probe's output to the oscilloscope thus increasing measurement range and accuracy.

The following graph shows the probe's input impedance versus frequency.

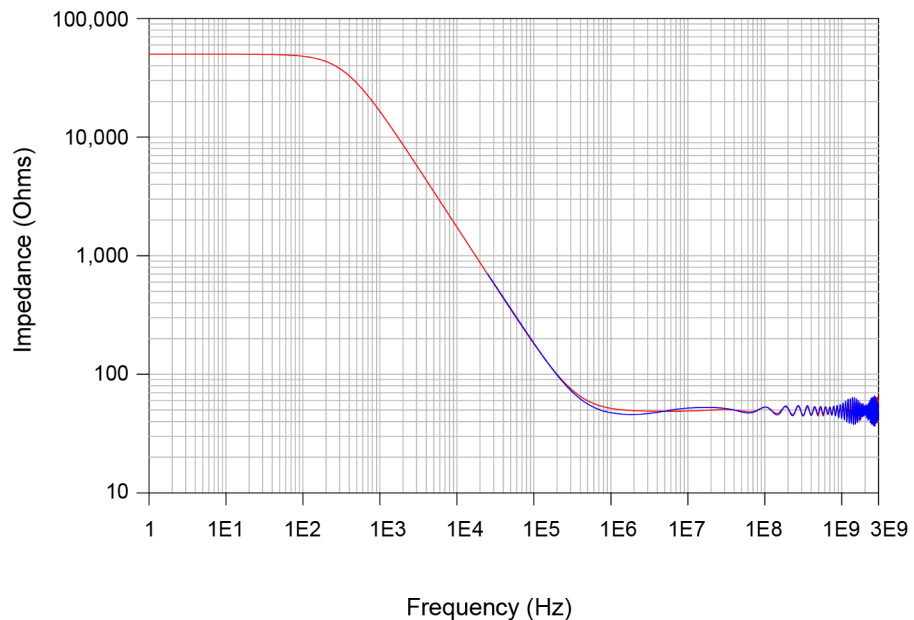

Figure 8 Input Impedance Versus Frequency, Z_{in} Measured, Z_{in} Modeled (N7020A with N7022A Main Cable)

Minimize Probe Ground Impedance for the Best Signal Fidelity

The N7020A and N7024A probes are single-ended probes that are designed for measuring small signals riding on large DC voltages. By using the oscilloscope's offset knob to offset the DC voltage, you can analyze a power rail using maximum vertical sensitivity. With no added noise other than a 10% increase to the oscilloscope channel's noise, due to low attenuation, these probes have very low input noise. For example, at maximum sensitivity on an S-series oscilloscope, the input-referred AC_{rms} noise is 140 μV_{rms} for N7020A.

To achieve the best signal fidelity, it is vital that the physical connection and ground impedance of the probe be minimized. Any unnecessary length in either the probe's signal or ground can potentially cause capacitive coupling and inductive pick-up larger than the signal of interest. These probes support three connection methods, well-suited for high fidelity measurements:

- The N7022A main cable, connected directly to an SMA port on the DUT, provides the highest fidelity since the ground and signal are intimately mated with an SMA connector. Connectors other than SMA such as SMB and SMC can be used with an appropriate adapter. The adapters are not supplied with the probe.
- The N7021A is a prepared coaxial-cable pigtail that allows the probe to be soldered to the DUT. It is recommended that the coaxial shield be soldered directly to ground, thus minimizing the ground impedance.
- The N7032A browser or N7033A browser with hand-held probing.

As with any single-ended probe, there may be a concern of creating a ground loop by the connection of the DUT ground to the probe/scope ground. This generally does not cause a measurement issue as long as the DUT ground is not radically different than the scope ground. You can test this by connecting the probe's ground and signal contacts to the DUT ground. You should not see any significant signal on the oscilloscope's screen.

Connecting to the DUT

You can connect the N7020A / N7024A probe to the DUT in a number of ways using various connection accessories shipped with these probes. The following figure illustrates these connection methods and the correct combination of accessories to be used for the most accurate measurements.

NOTE

The compatible Keysight oscilloscopes include S-parameter correction for the supplied N7021A and N7022A cables. Therefore, you should always use these cables as per the combinations shown in the figure below for the most accurate measurements.

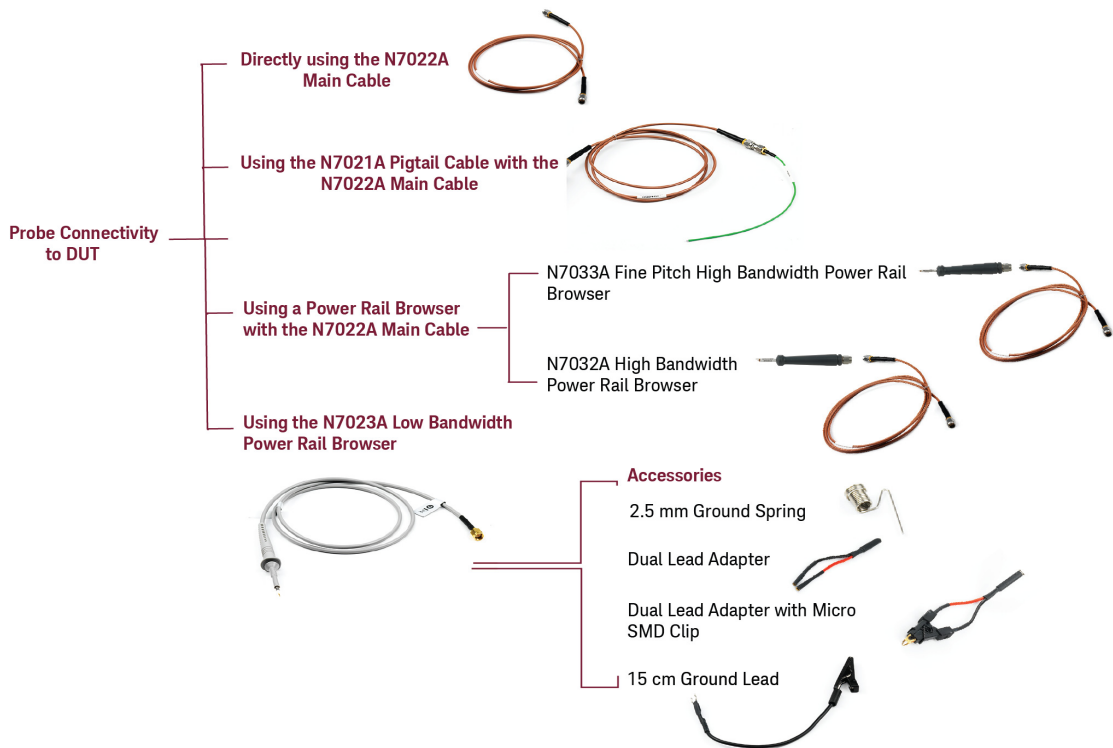

These methods are described in the sections that follow.

NOTE

Once you have made the hardware connection using the appropriate probe connection accessory (cables/browsers), ensure that the same hardware connection mechanism is reflected in the oscilloscope's Infiniium software GUI. You do this using the **Probe Configuration** dialog box. This ensures that you get accurate measurements as per the connection mechanism.

For instance, if you are using the N7022A main cable with the N7024A probe, then ensure that the Probe Configuration dialog box has **N7022A:N7024A Main Cable** as the selected head in the Probe Head section.

Direct Connection using the N7022A Main Cable

This connection mechanism allows you to directly probe DUTs that are located up to 1.2 meters from the probe thereby ensuring an easy connection to the target. The N7022A main cable is flexible and durable while still providing high signal fidelity.

The highest BW configuration for the N7024A Voltage Rail probe system is when the user has a 50 ohm line from a voltage rail on their DUT to an RF connector and this is connected to the N7022A coax and N7024A probe amp combination.

You can achieve the highest bandwidth configuration for the N7024A probe by connecting the N7022A main cable to an RF connector that connects to the DUT's power rail on a 50 Ω line.

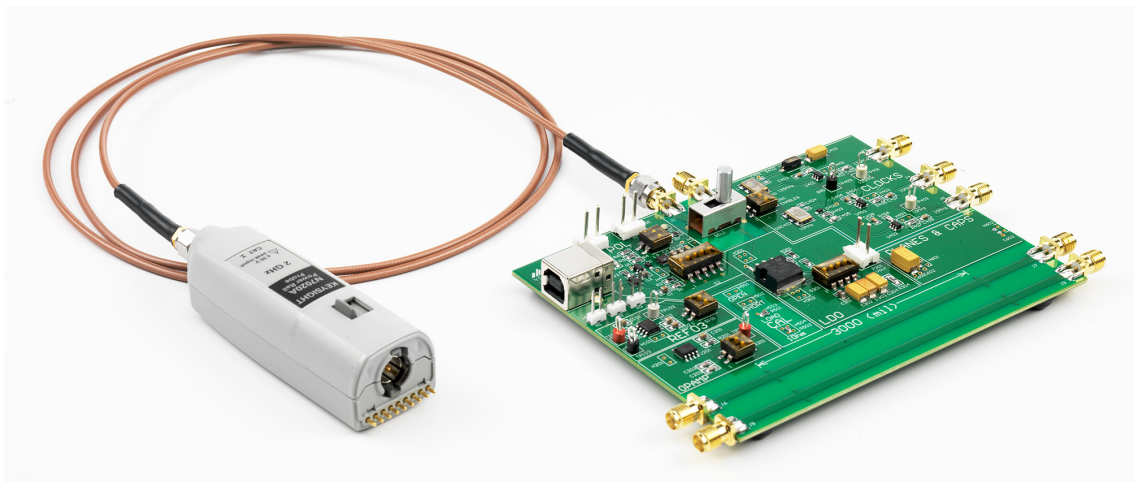

Using the N7021A Pigtail Cable and N7022A Main Cable

N7021A pigtail cables are flexible and durable and have a small diameter to minimize intrusions into target systems. The typical probing point will often be across a bypass capacitor with the cable's outside conductor soldered to ground.

- 1** Connect the probe to the N7022A main cable
- 2** Connect the main cable to the N7021A pigtail cable.
- 3** Use the supplied SMA adapter or Rotating adapter to connect the two cables.
- 4** Solder the pigtail cable to the DUT.

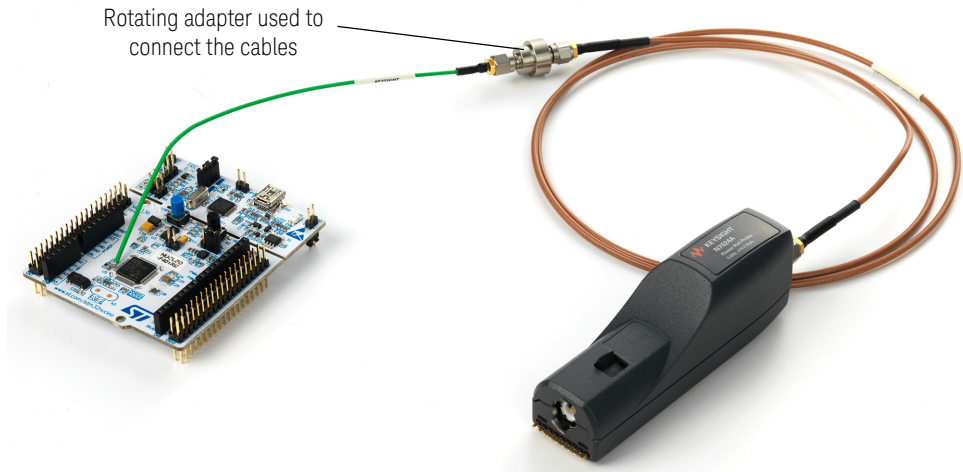

The figure below shows how to solder the end of a N7021A pigtail cable to a DUT.

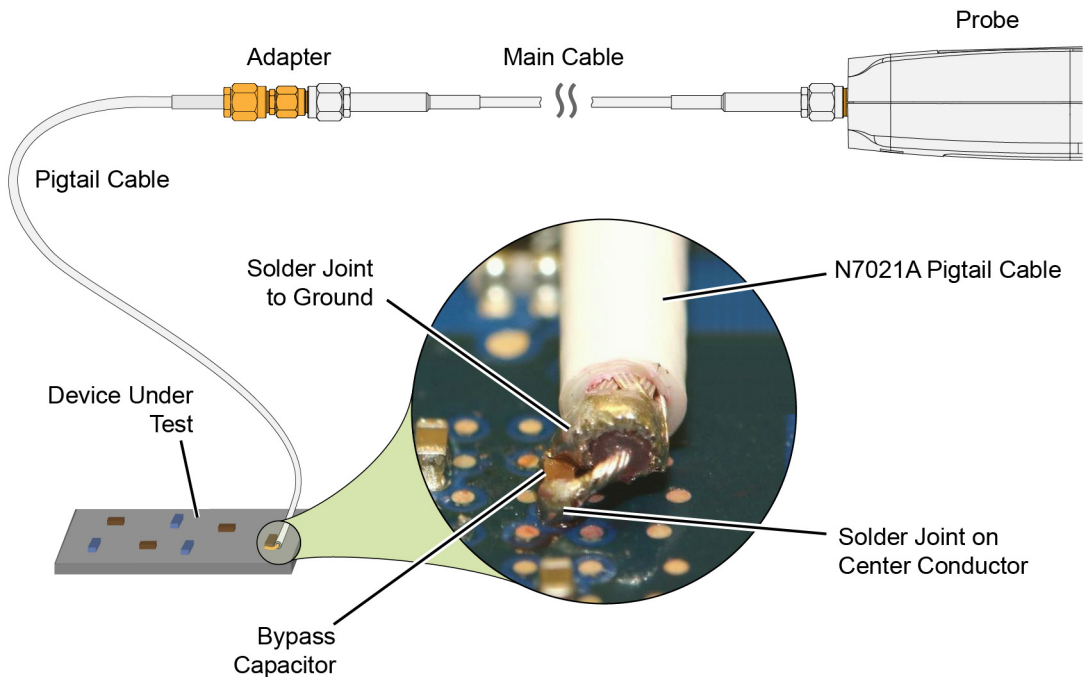

Figure 9 Soldering the Probing End of The N7021A Cable Across a Bypass Capacitor

CAUTION

To avoid accidentally shorting the circuit via the cable's exposed ground, place a small strip of non-conductive tape onto the board before attaching the coax. To avoid undue stress to the solder joints, tape the cable to the DUT.

Using a Power Rail Browser

The following browsers are available for use with the N7020A/N7024A probes. Based on your bandwidth requirements, you can choose the browser that you want to use. Refer to [Chapter 3](#), "Specifications and Characteristics" to know the capabilities of each of these browsers.

- N7023A Low Bandwidth Browser
- N7032A High Bandwidth Browser
- N7033A Fine Pitch High Bandwidth Browser

N7032A / N7033A Browser

Use the N7022A main cable to connect the probe to the N7032A / N7033A browser. Use the supplied SMA adapter or Rotating adapter to make this connection between the probe and browser.

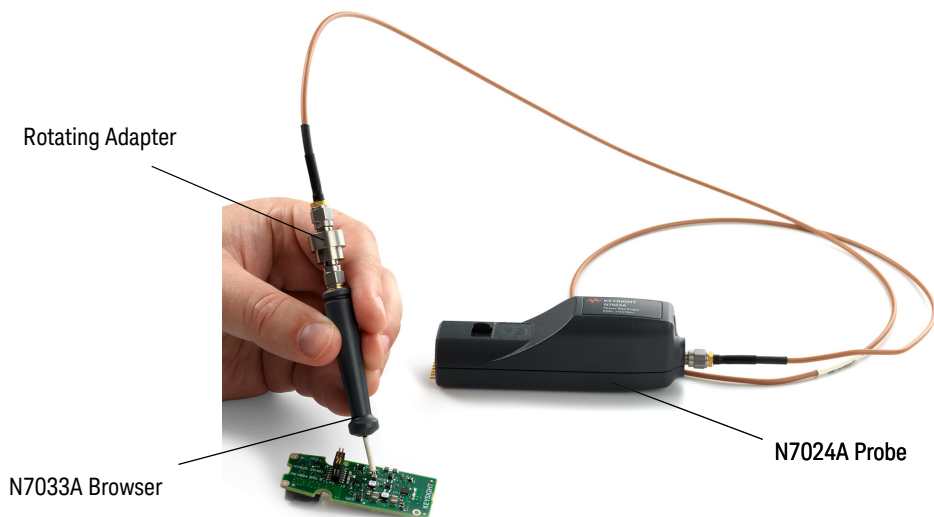

Hands-free probing with N7032A / N7033A browser

For hands-free stability, you can mount these browsers on the N2787A probe Positioner as displayed in the following figure.



N7023A Browser

- 1 Remove the N7022A main cable (if attached to the probe)
- 2 Replace this cable with the N7023A browser cable to make the connection between the probe and browser.



- 3 From the set of N7023A browser accessories, choose the accessory that best suits your requirement as per the probing point on the DUT. Connect this accessory to the browser tip as displayed in the figures below.

- Use the **Ground Spring** to get the highest performance connection for the N7023A browser. Its flexible construction makes it easy to vary the span between the input and ground to accommodate the device being probed.



- Use the **Ground Lead** to reach grounding locations that are farther away from the probing location than can be reached by the ground spring. However, the longer lead means it has a larger inductance in the ground return path which corresponds to a lower performance than using the ground spring.



- Use the **Dual Lead Adapter** to easily connect the N7023A browser to popular 0.1" pin headers with 0.025" square pins. This dual lead adapter has no shorting hazards since all external metal surfaces are insulated.

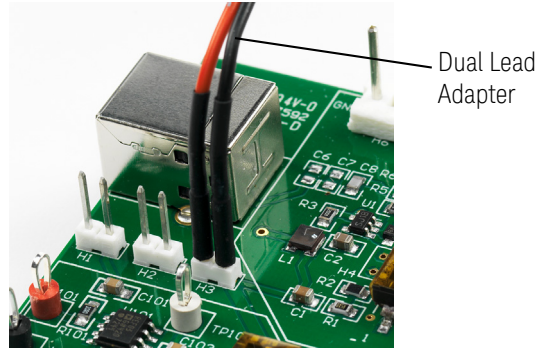

- Use the **Micro SMD clips** in conjunction with the dual lead adapter for fast and convenient hands-free probing of surface mount capacitors. It is a best practice to twist the leads of the dual lead adapter to reduce coupling of external noise into the probe.

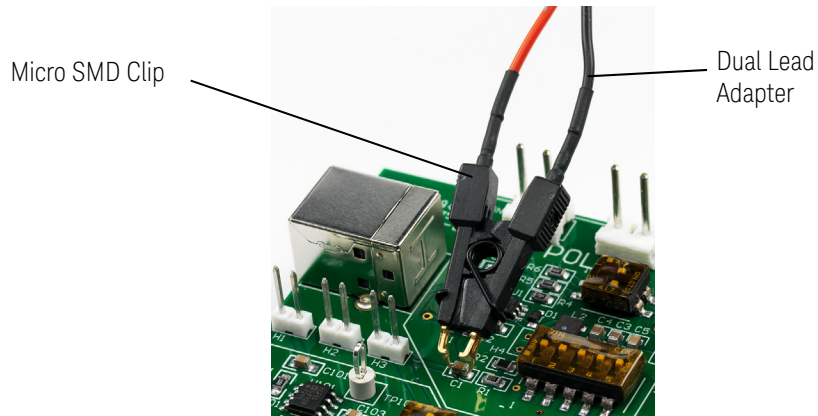

Replacing N7023A Probe Browser Tips

The solid tips and spring-loaded tips are replaceable. Spring loaded power rail probe browser tips offer a method of probing signals that is less susceptible to vibration or movement than traditional rigid tips. Many users find it easier to use this type of tip. The spring loaded tips work when they are either partially or fully compressed and are protected against over compression damage.

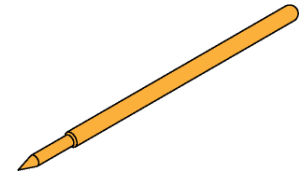

To change the N7023A power rail probe browser tip, use pliers to grip the tip and pull it straight out of its contact socket along the axis of the N7023A power rail probe browser. Do not grip the plastic insulator or the housing with the pliers because the tip could be crushed (see Figure 10). This could result in being unable to remove the tip and/or damaging the



N7023A power rail probe browser. Once the N7023A power rail probe browser tip is removed, the new tip can be inserted with pliers into the contact socket along the axis of the N7023A power rail probe browser. In order to insert the N7023A power rail probe browser tip completely into the housing, carefully press the browser tip against a hard surface.

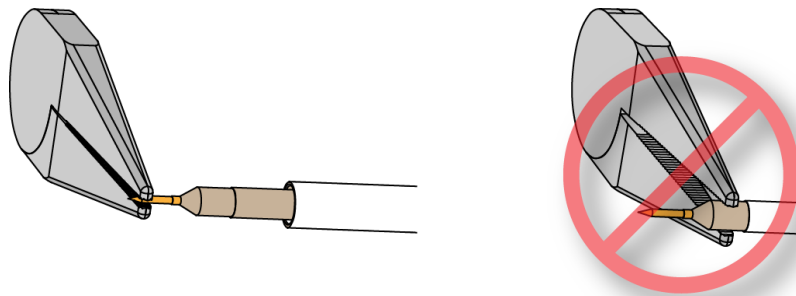

Figure 10 Proper Tip Removal Technique

WARNING

You should exercise caution when using these sharp browser tips to avoid personal injury.

Avoiding Costly Repairs

When connecting or using the probe, use caution to avoid damaging the oscilloscope's channel input circuits due to electrostatic discharge (ESD).

CAUTION

When the probe is connected to the oscilloscope, the oscilloscope's channel input circuits can be damaged by electrostatic discharge (ESD). Avoid applying static discharges to the probe input. Prior to energizing and connecting any accessory cable to the probe, momentarily short the center and outer conductors of the cable together. Be sure that the instrument is properly earth-grounded to prevent buildup of static charge. Wear a wrist-strap or heel-strap.



Figure 11 on page 52 shows an example of a static-safe work station using two types of ESD protection:

- Conductive table-mat and wrist-strap combination.
- Conductive floor-mat and heel-strap combination.

Both types, when used together, provide a significant level of ESD protection. Of the two, only the table-mat and wrist-strap combination provides adequate ESD protection when used alone. To ensure user safety, the static-safe accessories must provide at least 1 M Ω of isolation from ground. Purchase acceptable ESD accessories from your local supplier.

WARNING

These techniques for a static-safe work station should not be used when working on circuitry with a voltage potential greater than 500 volts.

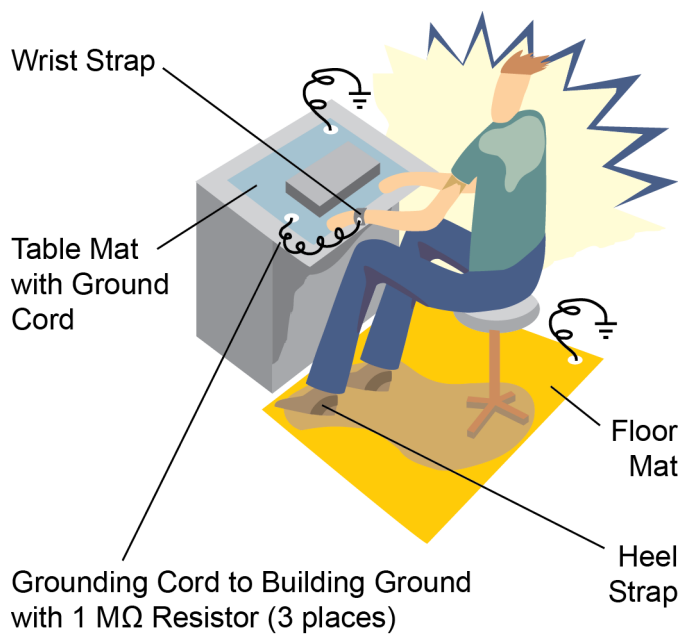

Figure 11 ESD Workstation

Common Types of Power Integrity Measurements

The following are some of the common types of power integrity measurements that you can make using the N7020A / N7024A probe:

- Static and dynamic load response.

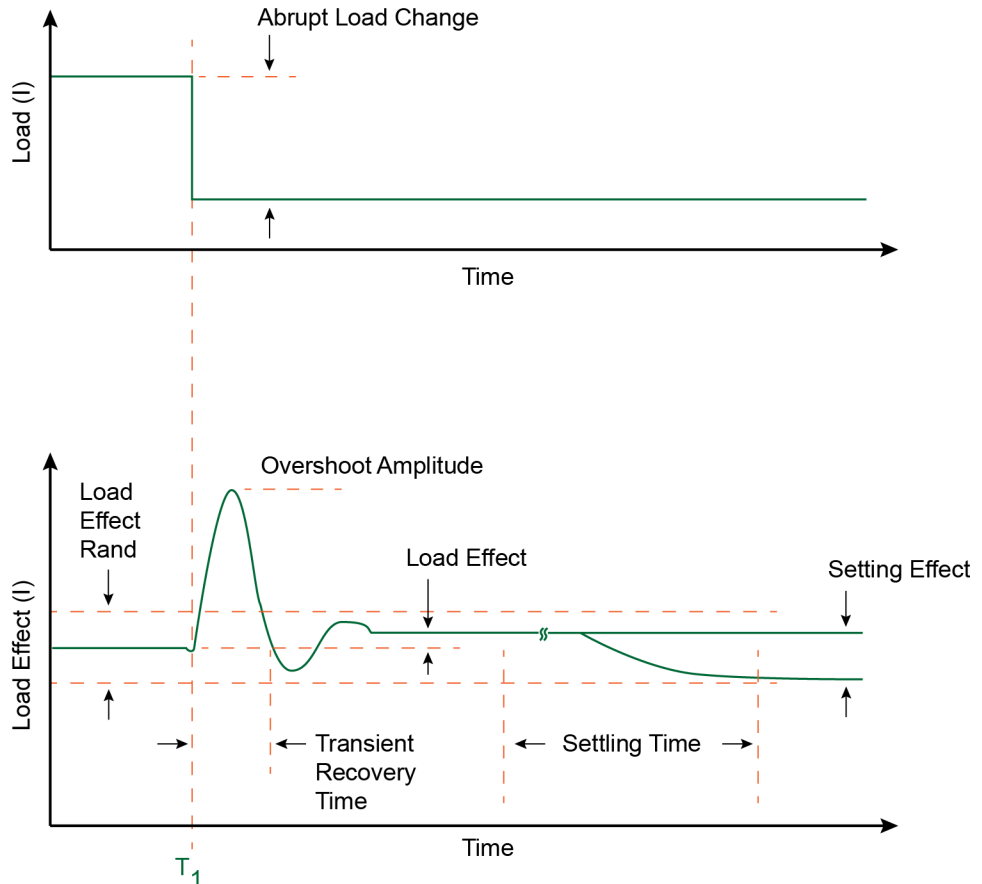

Figure 12 Example of Response to Changing Load

- Supply drift.
- Programmable power rail response.

- High frequency transients and noise.
- PARD (Periodic and Random Disturbances) such as noise, ripple, and switching transients on power rails.

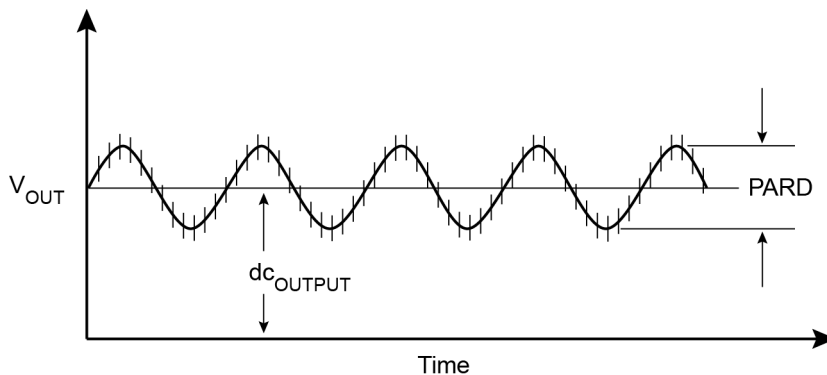

Figure 13 Example of PARD on DC Output

- Product electrical validation at extended temperatures.

6 Calibrating

N7020A / N7024A Probe's DC Attenuation/Offset Calibration Using N7022A Main Cable **56**

N7020A / N7024A Probe's DC Attenuation/Offset Calibration Using N7023A Probe
Browser **57**

Always calibrate the probe before making any critical measurements. A probe calibration removes attenuation errors, offset errors, and timing delays that are introduced by the probe. This chapter contains basic calibration procedures for the supported Infiniium oscilloscopes. For additional information on the probe calibration, refer to the oscilloscope's user documentation.

CAUTION

Always wear an ESD wrist strap when working with active probes. Not doing so can result in the probe becoming permanently damaged.

The following calibrations are described in this chapter:

- N7020A / N7024A Probe's DC Attenuation/Offset Calibration Using N7022A Main Cable
- N7020A / N7024A Probe's DC Attenuation/Offset Calibration Using N7023A Power Rail Probe Browser

N7020A / N7024A Probe's DC Attenuation/Offset Calibration Using N7022A Main Cable

- 1 Turn on the oscilloscope and connect the N7020A / N7024A probe with the N7022A main cable attached to one of the oscilloscope's input channels.
- 2 Allow the oscilloscope to warm up for 20 minutes.
- 3 If the oscilloscope needs calibration, perform a user calibration before the probe calibration. On the oscilloscope, click **Utilities** > **Calibration**.
- 4 Connect the output of the N7022A main cable to the oscilloscope's rear-panel AUX OUT BNC connector as shown in the following picture. You'll need a BNC (m) to SMA (f) adapter.

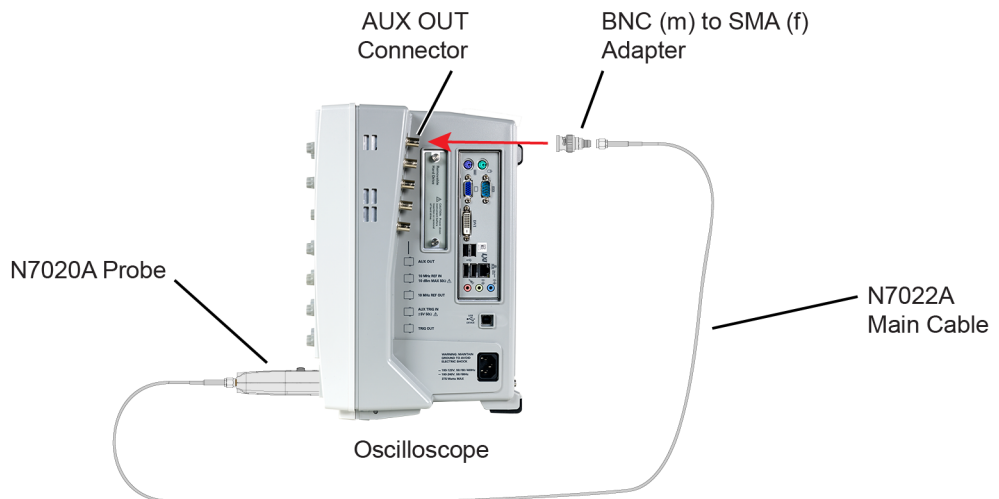

Figure 14 Calibration Setup

- 5 On the oscilloscope, click **Setup** > **Probes**.
- 6 In the Probe Calibration dialog box, select the tab representing the channel that has the probe attached.
- 7 In the dialog box, select the type of calibration. Click **Start** and follow the instructions shown on the oscilloscope.

N7020A / N7024A Probe's DC Attenuation/Offset Calibration Using N7023A Probe Browser

- 1 Turn on the oscilloscope and connect the N7023A power rail probe browser with the N7020A / N7024A probe attached to one of the oscilloscope's input channels.
- 2 Allow the oscilloscope to warm up for 20 minutes.
- 3 If the oscilloscope needs calibration, perform a user calibration before the probe calibration. On the oscilloscope, click **Utilities > Calibration**.
- 4 Connect the ground lugs and the output of the N7023A power rail probe browser to the oscilloscope's front-panel PROBE COMP connector.
- 5 On the oscilloscope, click **Setup > Probes**.
- 6 In the Probe Calibration dialog box, select the tab representing the channel that has the probe attached.
- 7 In the dialog box, select the type of calibration. Click **Start** and follow the instructions shown on the oscilloscope.

NOTE

After the calibration is complete, the probed waveform from the PROBE COMP connector may not look an optimally compensated square waveform. This is because the probed waveform is the standard original waveform usually present at the PROBE COMP connector. It is not related to the calibration procedure that you completed and therefore does not indicate that the calibration has failed.

7 Performance Plots

N7020A Performance Plots	60
N7020A Input Impedance Equivalent Model	64
N7024A Performance Plots	66
N7024A Input Impedance Plots	68

This chapter includes plots that show the characteristic performance and an input impedance model of the N7020A and N7024A probes.

N7020A Performance Plots

The performance characteristic plots in this section are for the N7020A probe with the N7022A main cable attached.

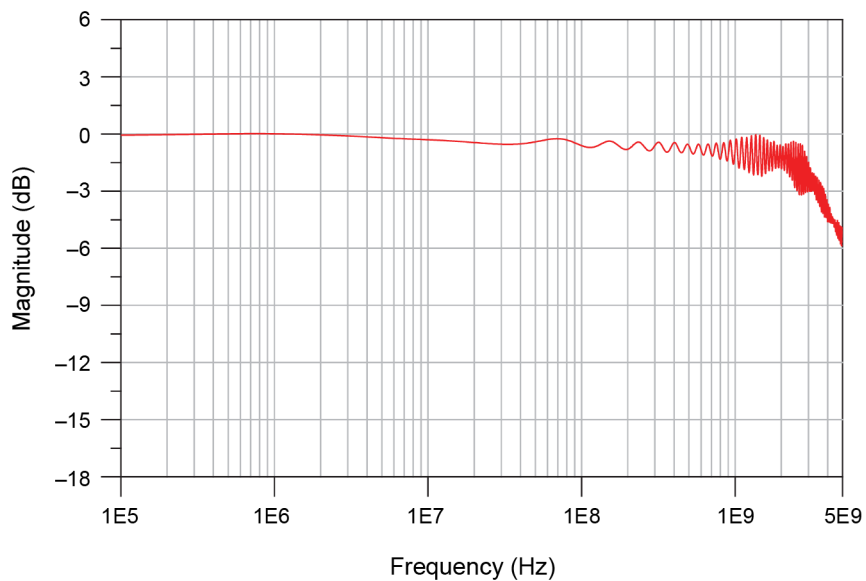

Figure 15 Normalized Frequency Response, V_{out}/V_{in} , 2.5 GHz BW
(N7020A with N7022A Main Cable)

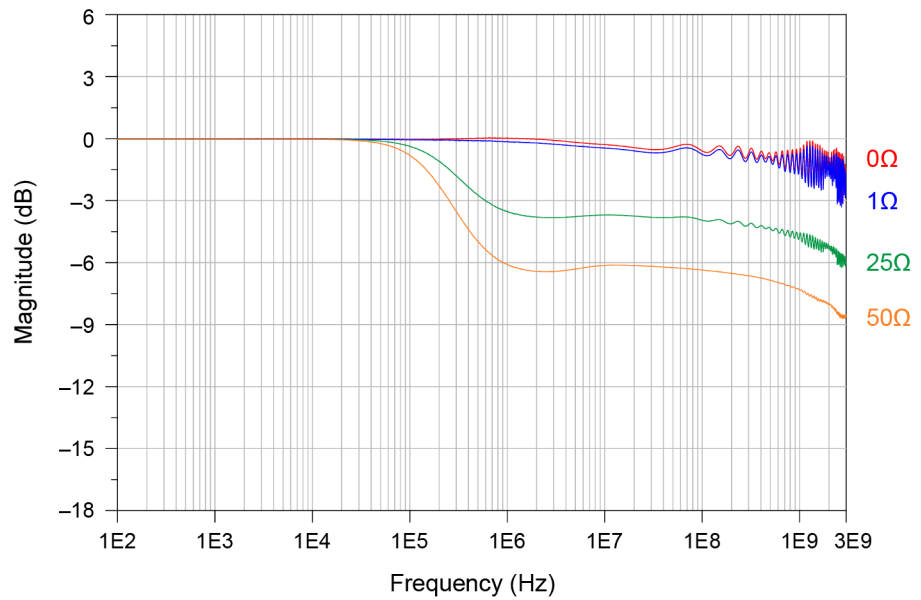
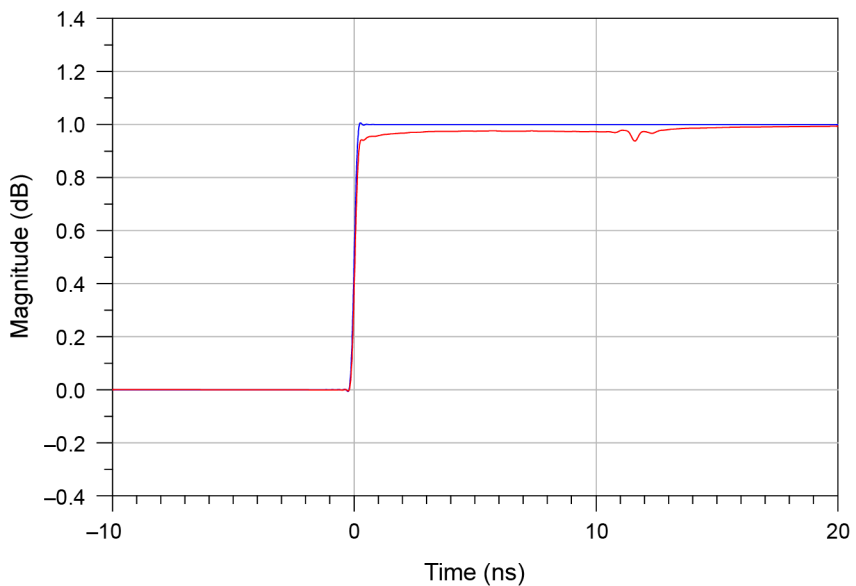

Figure 16 Frequency Response for Different DUT Impedances (N7020A with N7022A Main Cable)



Rise Time, Input Step (10/90%): 250 ps
 Rise Time, Input Step (20/80%): 169 ps
 Rise Time, N7020A with N7022A (10/90%): 297 ps
 Rise Time, N7020A with N7022A (20/80%): 192 ps

Figure 17 Step Tracking (N7020A with N7022A Main Cable)

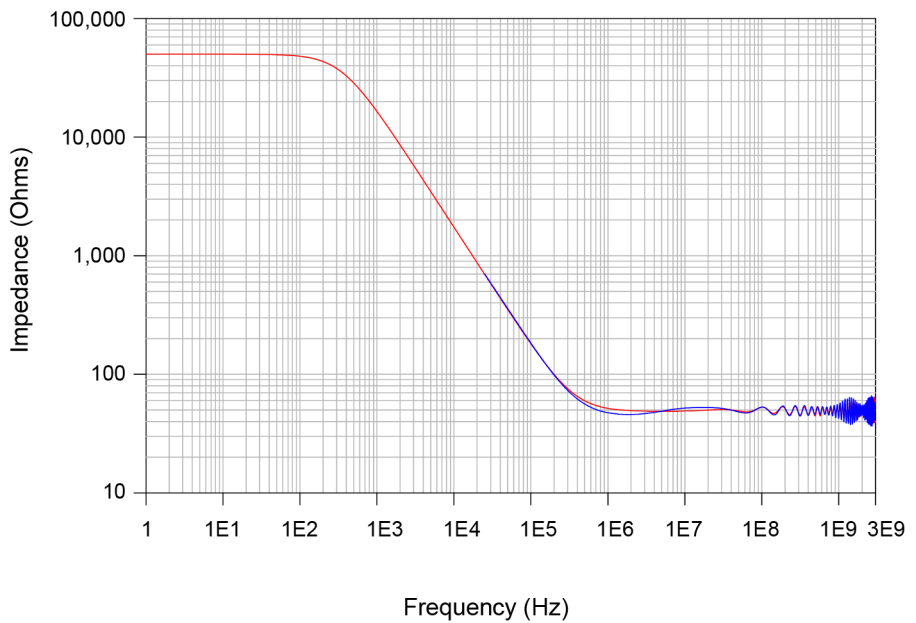

Figure 18 Input Impedance Versus Frequency, Z_{in} Measured, Z_{in} Modeled (N7020A with N7022A Main Cable)

N7020A Input Impedance Equivalent Model

The following Netlist is for the N7020A input impedance equivalent model shown in [Figure 19](#) on page 65.

```
* source N7020A
.EXTERNAL INPUT Vin
.EXTERNAL OUTPUT Vout
R_R3 GND N01679 590
T_T8 N01635 GND N01646 GND Z0=51.7174 TD=177.789ps
T_T4 N01611 GND N01614 GND Z0=50.0323 TD=5.00049ns
T_T9 N01646 GND N01649 GND Z0=56.0807 TD=124.106ps
T_T10 N01649 GND N01652 GND Z0=52.0547 TD=194.457ps
T_T5 N01614 GND N01629 GND Z0=55.4861 TD=14.8781ps
T_T16 N01709 GND VOUT GND Z0=50.4332 TD=1.00771ns
T_T15 N01706 GND N01709 GND Z0=50.9109 TD=173.772ps
C_C1 N01652 N01667 9n
R_R2 N01667 N01670 3.9
T_T11 N01670 GND N01673 GND Z0=47.0657 TD=32.9877ps
T_T12 N01673 GND N01676 GND Z0=48.4028 TD=97.8628ps
T_T14 N01679 GND N01706 GND Z0=51.4414 TD=471.443ps
T_T6 N01629 GND N01632 GND Z0=52.1033 TD=38.7418ps
T_T13 N01676 GND N01679 GND Z0=48.0776 TD=53.1542ps
T_T1 Vin GND N01605 GND Z0=49.0683 TD=148.305ps
R_R4 GND VOUT 50
T_T2 N01605 GND N01608 GND Z0=49.4981 TD=107.256ps
T_T7 N01632 GND N01635 GND Z0=50.8744 TD=76.0454ps
T_T3 N01608 GND N01611 GND Z0=49.4457 TD=277.663ps
R_R1 GND N01635 50k
```

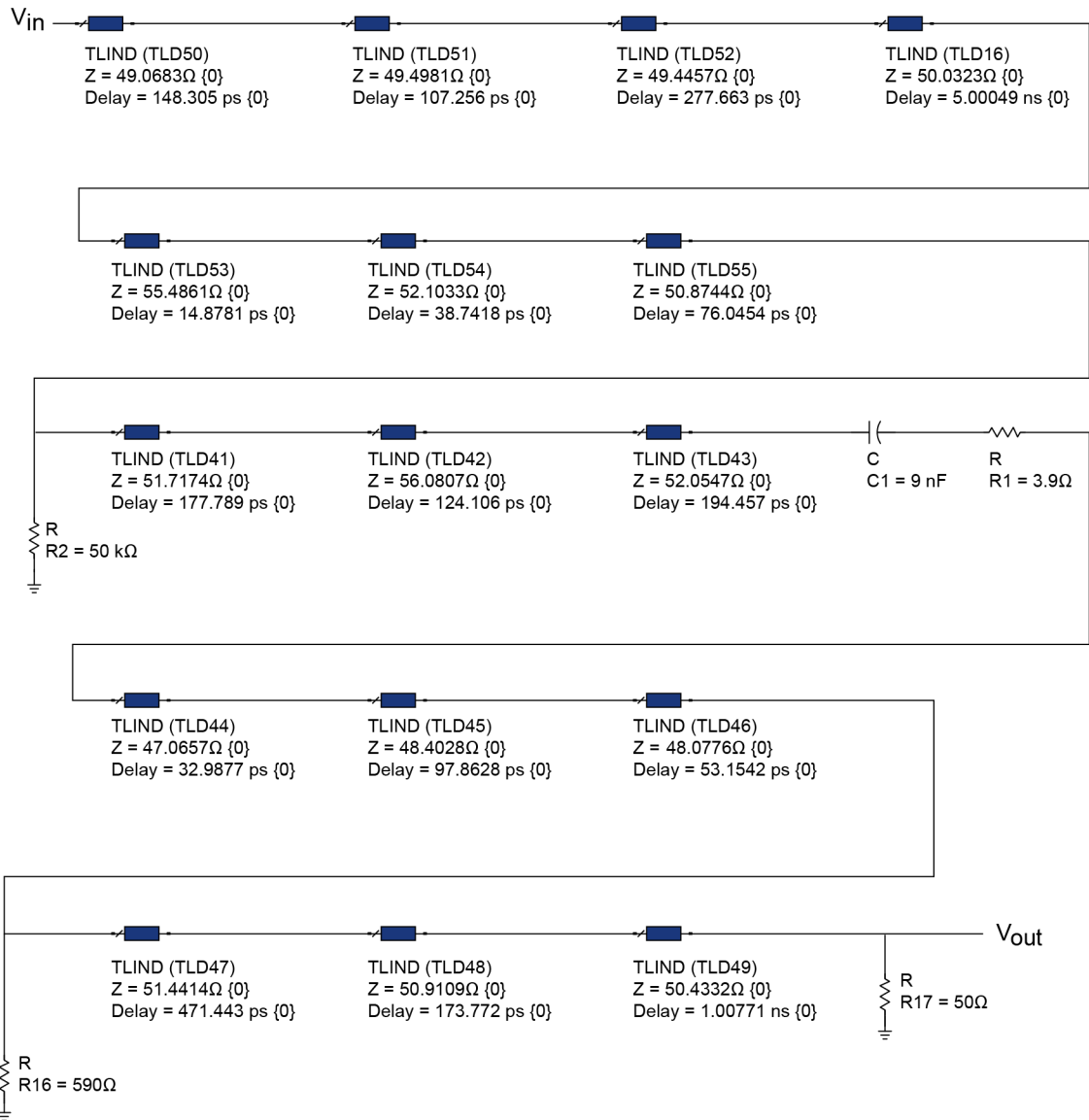



Figure 19 Input Impedance Equivalent Model

N7024A Performance Plots

N7024A Probe System Responses

Most high performance active probes for use with Infiniium real-time oscilloscopes utilize DSP correction filters to enhance the measurements accuracy. Probes like the N7024A store their unique s parameters in on-board memory for the scope to readout when needed. Probe heads are simple passive devices and, with careful manufacture, their s-parameters don't vary significantly so they are stored as nominal s-parameters in the oscilloscope. When a probe is connected to an oscilloscope channel and the proper probe head is selected, the oscilloscope calculates a DSP correction filter that includes the probe head, probe amplifier, and oscilloscope channel. This provides the maximum measurement accuracy for the complete probe and scope channel system. Since there are different probe amplifiers and probe head combinations, it is not reasonable to show the responses of all these combinations and the responses would all be very much the same because they are all corrected to same target system response. The target system response is a flat magnitude, flat phase response high order low-pass filter that maximizes measurement accuracy.

Figure 20 shows an example of a typical corrected system frequency response of the N7024A probe when used with the N7022A main cable. This is the V_{out}/V_{in} response which is indicative of the response seen when probing a very low impedance voltage rail.

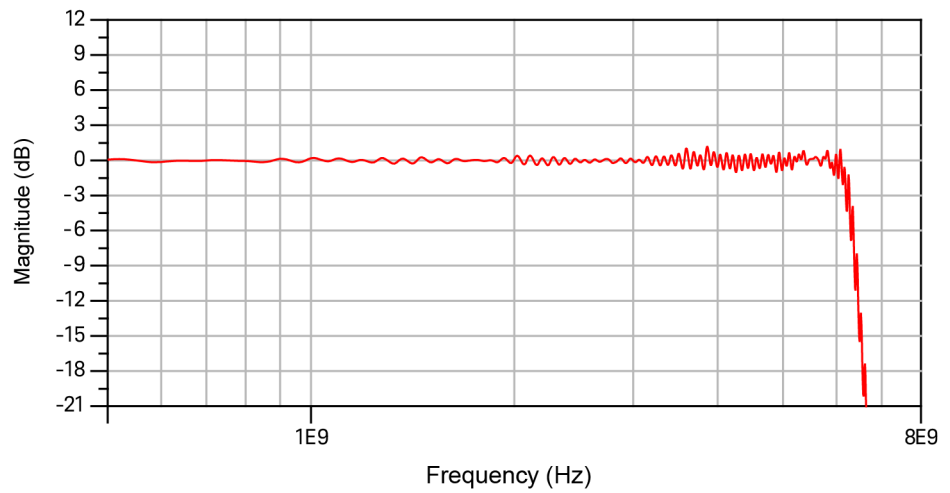

Figure 20 Typical Corrected Frequency Response for the N7022A Main Cable and N7024A Probe Combination

N7024A Input Impedance Plots

This section provides the input impedance plots for various probe configurations available for N7024A based on the different probe and probe head combinations.

N7024A Simplified Input Impedance Model

Figure 21 shows the model used in the measured and modeled input impedance plots provided for the N7024A probe in this section.

In this model, the value of the inductance L varies for various supported probe configurations. This value is provided with the input impedance plot of each of these probe configurations in this section.

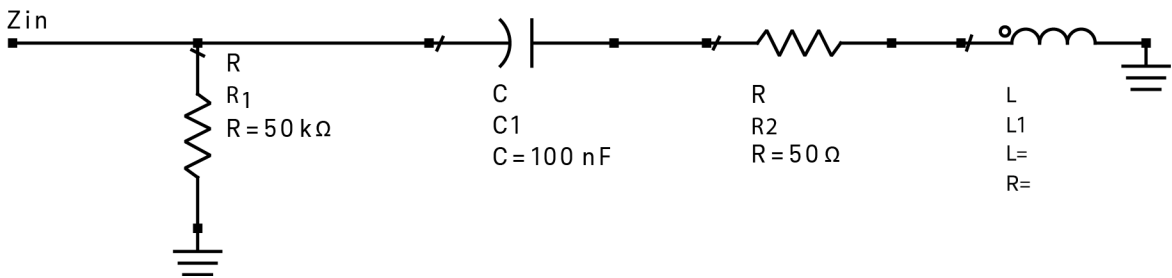

Figure 21 Input Impedance Model for the N7024A Probe

Input Impedance Plot for N7022A Main Cable and N7024A Probe Combination

This combination supports the highest bandwidth configuration for the N7024A probe. In this combination, the value of the inductance L is zero.

Figure 22 shows the input impedance looking into the N7022A cable. Any added transmission line and/or connection parasitic on the DUT will modify this impedance.

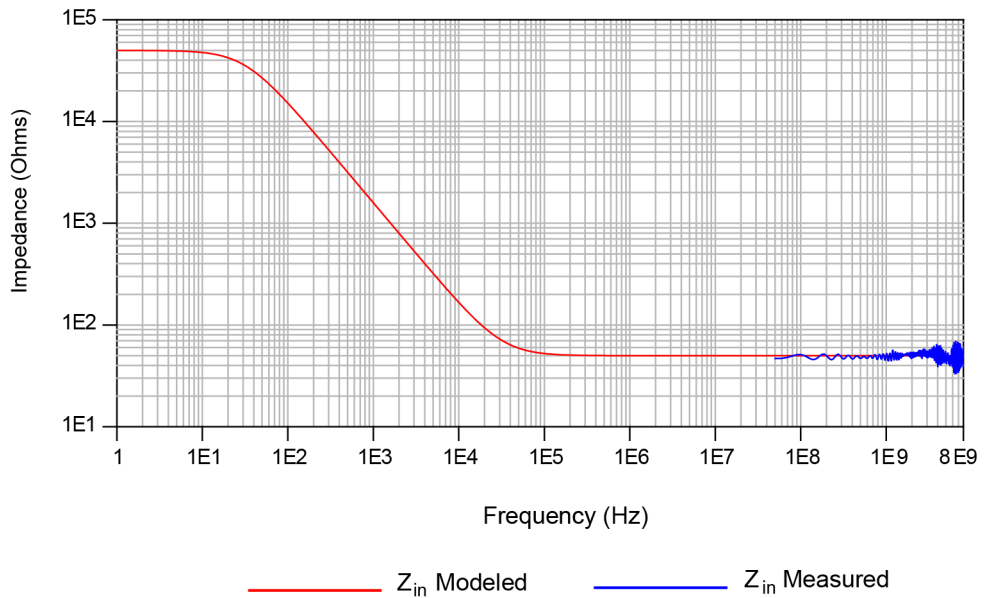

Figure 22 Input Impedances (Z_{in} Modeled and Z_{in} Measured) for the N7022A Main Cable and N7024A Probe Combination

Input Return Loss Plot for N7022A Main Cable and N7024A Probe Combination

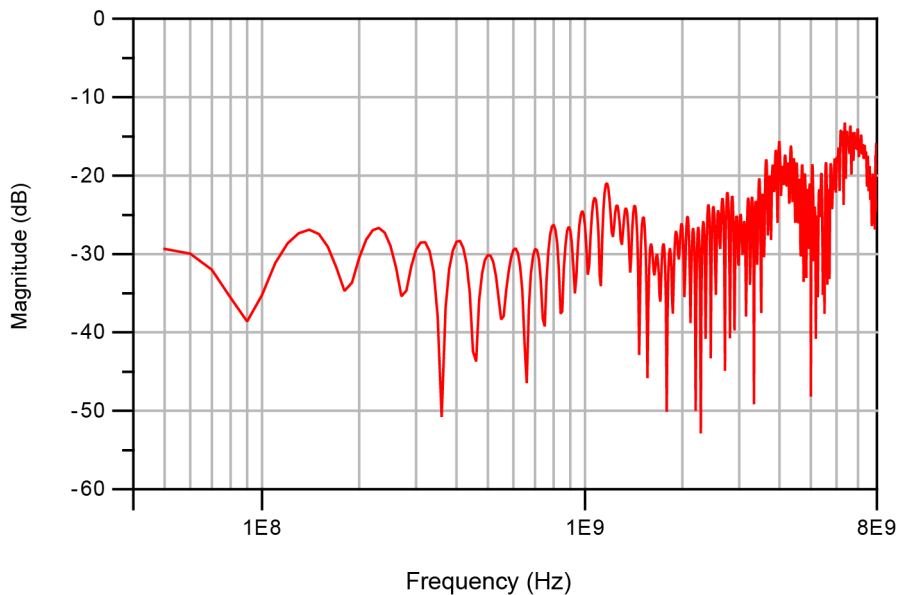

Figure 23 Input Return Loss Plot for the N7022A Main Cable and N7024A Probe Combination

Input Impedance Plot for N7021A Pigtail Cable, N7022A Main Cable, and N7024A Probe Combination

In this combination, the value of the inductance L is 1nH.

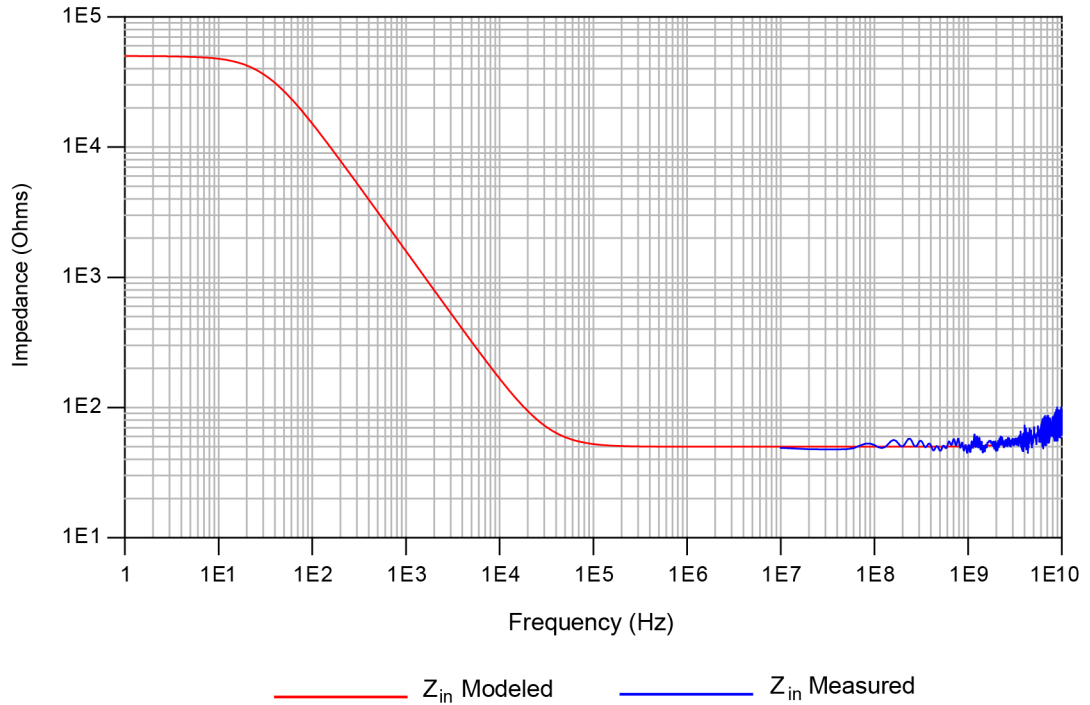

Figure 24 Input Impedances (Z_{in} Modeled and Z_{in} Measured) for the N7021A Pigtail Cable, N7022A Main Cable, and N7024A Probe Combination

Input Impedance Plot for N7032A Browser, N7022A Main Cable, and N7024A Probe Combination

In this combination, the value of the inductance L is 1.85 nH.

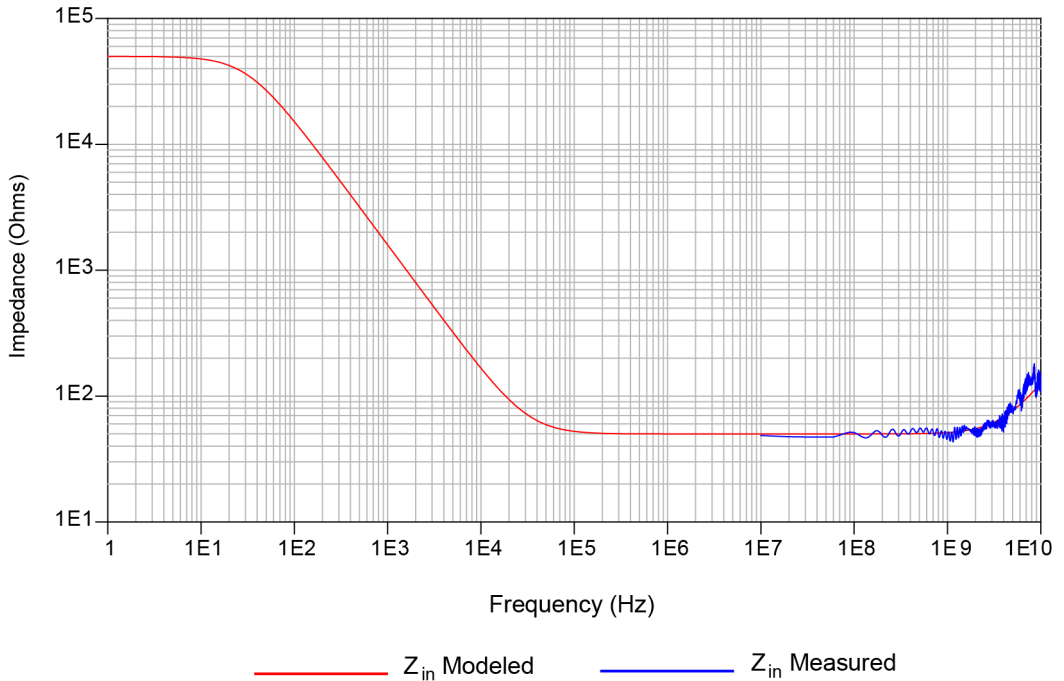

Figure 25 Input Impedances (Z_{in} Modeled and Z_{in} Measured) for the N7032A Browser, N7022A Main Cable, and N7024A Probe Combination

Input Impedance Plot for N7033A Browser, N7022A Main Cable, and N7024A Probe Combination

In this combination, the value of the inductance L is 1.5 nH.

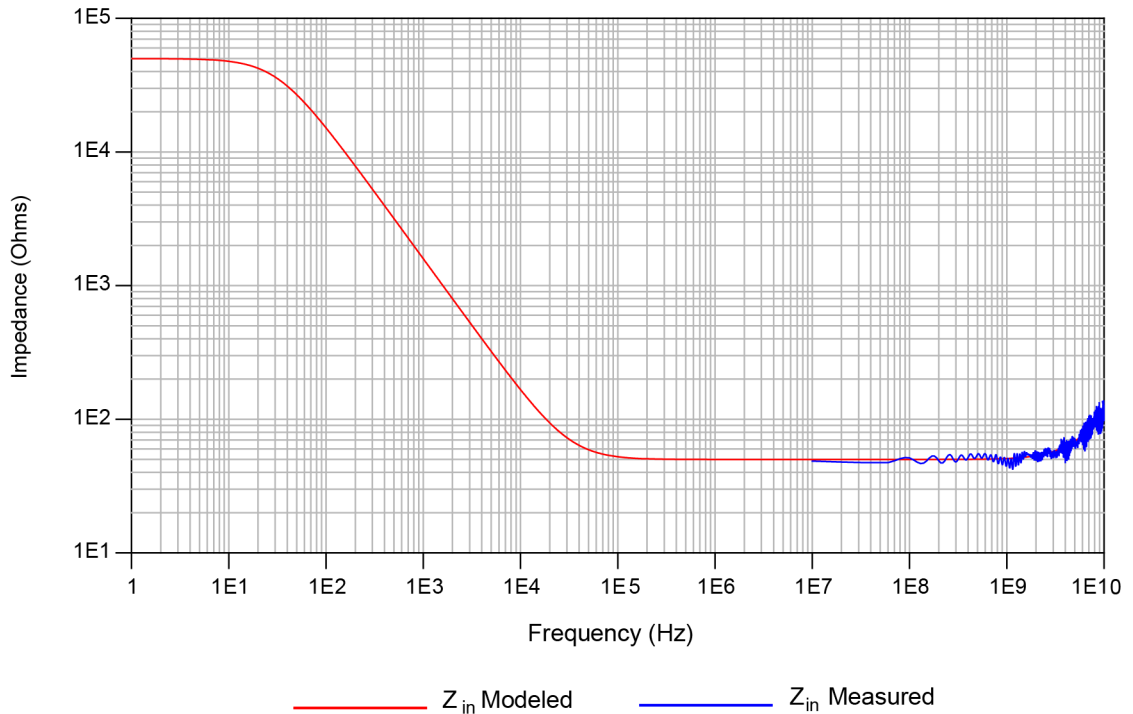

Figure 26 Input Impedances (Z_{in} Modeled and Z_{in} Measured) for the N7033A Browser, N7022A Main Cable, and N7024A Probe Combination

8 Performance Verification

DC Input Resistance Performance Verification **76**

Bandwidth Performance Verification for N7024A Probe **79**

CAUTION

Electrostatic discharge (ESD) can quickly and imperceptibly damage or destroy high performance probes, resulting in costly repairs. Always wear a wrist strap when handling probe components and ensure that cables are discharged before being connected.

DC Input Resistance Performance Verification

This section provides information to test that the N7020A / N7024A probe meets its warranted DC input resistance, which is $50\text{ k}\Omega \pm 2\%$.

NOTE

Allow the N7020A probe to warm up for at least 20 minutes.

Recommended Test Interval

The recommended test interval is 1 year.

Required Test Equipment

Test Equipment	Critical Specification	Keysight Model Number
Oscilloscope	Supported Oscilloscope	Refer to the topic " Oscilloscope Compatibility " on page 16 to get a list of supported oscilloscopes.
Digital Multimeter	2 wire resistance accuracy $> \pm 0.01\%$	34401A or equivalent
Adapter	BNC (f) to SMA (m) (In E2655C Kit)	E2655-83201

Procedure

- 1 Connect the equipment as shown in [Figure 27](#).
- 2 Power on the oscilloscope with the oscilloscope application maximized.
- 3 Power on the DMM and select the 2-wire Ohm display on the DMM.

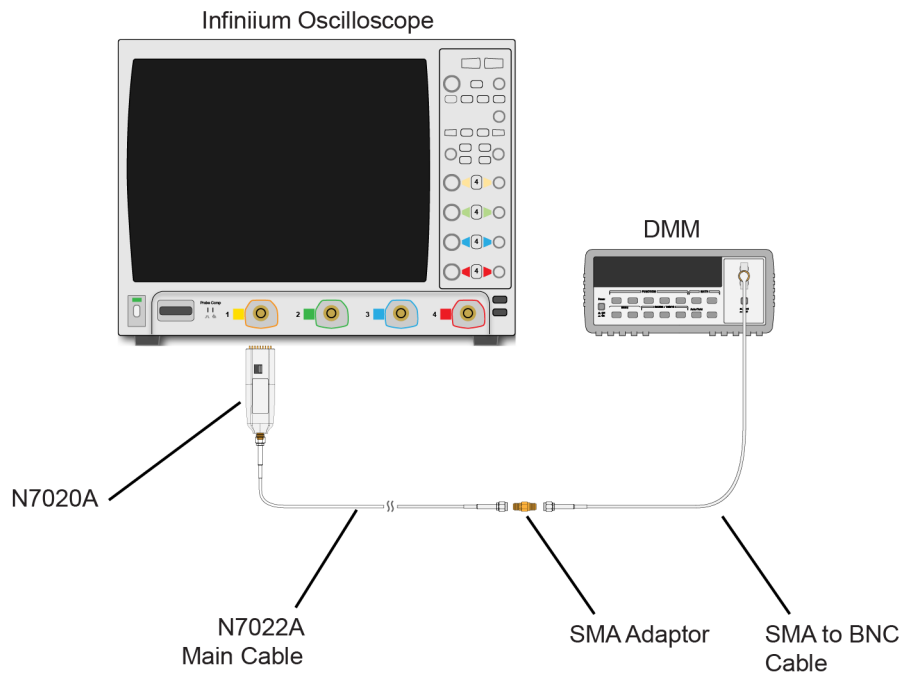

Figure 27 Test Setup

- 4 Read the DMM display for the input resistance.
- 5 Record the result in [Table 12](#) on page 78. To pass this test the result should be between 49 k Ω and 51 k Ω .

Performance Test Record

Serial #:
 Date:
 Tested by:
 Recommended Next Test Date:

Table 12 Input Impedance Test Results

Test Limits	Result	Pass/Fail
50 k Ω \pm 2%		

Bandwidth Performance Verification for N7024A Probe

This section provides information to test that the N7024A probe meets its warranted bandwidth specification, which is 6 GHz. As the warranted specification is just for the N7024A probe, this performance verification procedure verifies the bandwidth of just the N7024A probe without its N7022A main cable.

Recommended Test Interval

The recommended test interval is 1 year.

Required Test Equipment

Test Equipment	Critical Specification	Keysight Model Number
Infiniium Oscilloscope	Supported oscilloscope with bandwidth ≥ 8 GHz	Refer to the Table 3 to get a list of supported oscilloscopes.
Precision BNC Adapter	If V or Z-series Infiniium oscilloscope (with AutoProbe 2 inputs) is being used	N5442A
Precision BNC (M) to SMA (F) Adapter	If S-series Infiniium oscilloscope (with AutoProbe 1 inputs) is being used	54855-67604
Calibration Coaxial Cable	The calibration cable that accompanies the oscilloscope or A high quality 3.5mm or 2.92mm coax cable	Example - 54916-61626
Adapters to connect the coax cable to Cal Out and channel input on the oscilloscope	SMA f-f adapters that accompany the oscilloscope or 3.5mm or 2.92mm SMA f-f adapters	Example - 54916-68716

Procedure for Verifying Bandwidth Specification (for the N7024A Probe Only)

- 1 Power on the oscilloscope.

NOTE

Before starting the performance verification, allow the oscilloscope to warm up for at least 20 minutes.

- 2 Choose **Control** > **Default Setup** or press the [**Default Setup**] key on the front panel of the oscilloscope to configure the oscilloscope to its default settings.
- 3 Connect one end of the calibration coax cable to one of the input channels of the oscilloscope.
- 4 Connect the other end of the calibration coax cable to the Cal Out connector on the front panel of the oscilloscope.

NOTE

Use the 3.5mm or 2.92mm SMA female to female adapters to make these connections to Cal Out and input channel of oscilloscope.

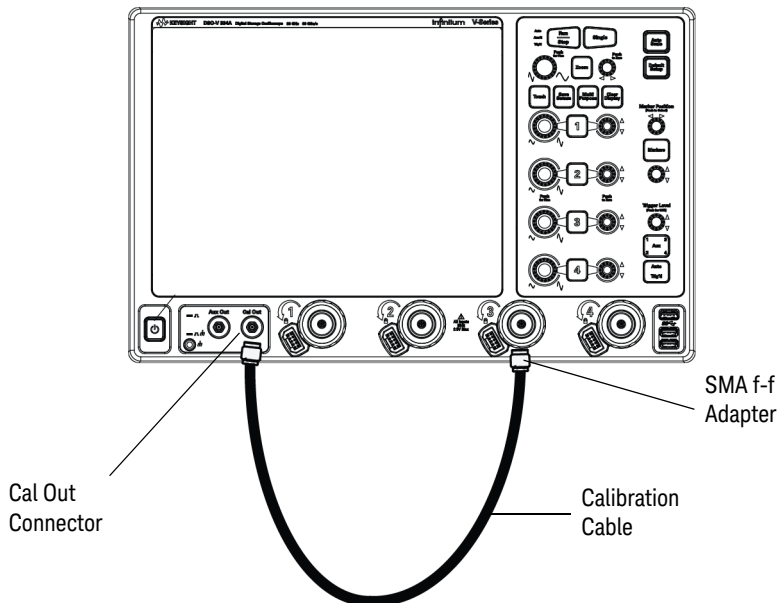

Figure 28 Calibration setup with the calibration cable

- 5 Press [**Auto Scale**] on the front panel.
- 6 Choose **Setup** > **Acquisition**, then select the **Enabled** checkbox for **Averaging** and set the **# of averages** to **1024**.

- 7 Set timebase to **2ns/div**.
- 8 Choose **Setup > Math Functions...** or **Math > Functions...**
- 9 In the **Function** dialog box, select the tab of the function **f1** to define it.
- 10 From the **Function 1** listbox, select **Math** and then **Differentiate**.
- 11 From the **Source 1** drop-down listbox, select the input channel of the oscilloscope to which you connected the calibration cable. This will become the source on which the f1 function will be performed.
- 12 Deselect the **Low Pass and Align Phase** checkbox.
- 13 Select the tab of the function **f2** to define it.
- 14 From the **Function 2** listbox, select **FFT**.
- 15 Turn the function display on for f2 by selecting the **On** checkbox.
- 16 Set the source for f2 to **Function 1** and close the Function dialog box. The oscilloscope is configured as displayed in the figure below.



Figure 29 Oscilloscope's user interface as per the functions defined

- 17 In the **f2** display area, set the following for f2:
 - stop frequency to **10 GHz**.
 - vertical scale to **3dbm/div**.
- 18 Record and save the frequency response of the Cal Out step through the attached calibration coax cable. To do this, perform the following steps.
 - a The f2 trace is displayed at the bottom of the screen. Drag the f2 trace to the center graticule.
 - b Save the frequency response of the coax cable by right-clicking the f2 trace and saving it to **memory 1**. This will allow you to later compare the saved frequency response of the Cal Out step through the attached calibration coax cable with the frequency response of the N7024A probe (done in steps that follow).
 - c For ease of comparison, drag the memory 1 trace into the same window as the f2 trace. Close the window that was initially displayed for memory 1.



Figure 30 Frequency response of the Cal Out step through the attached coax cable

- 19 Check the frequency response of the N7024A probe. To do this, perform the following steps.
- Disconnect the calibration coax cable and any adapters that you attached to the input channel of the oscilloscope.
 - Connect the N7024A probe to the input channel and calibration coax cable. You may need to use the N5442A adapter with the probe in case you are using a V-series or a Z-series oscilloscope.

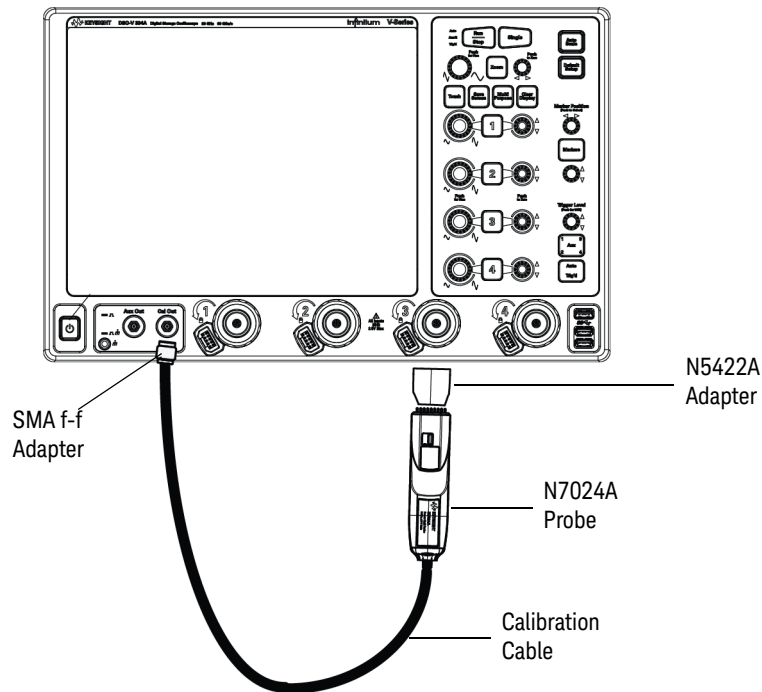

Figure 31 Calibration setup with the N7024A probe and calibration cable

- Choose **Setup > Probe Configuration....**
- Select the tab of the oscilloscope's input channel to which the probe is connected.
- In the **Probe Head** block, click **Select Head...** Select **Generic:User Cable** to configure the oscilloscope to not consider any loss from the N7022A main cable or any probe browsers. Click **OK** and close the dialog.

- f Set the channel offset for the oscilloscope to **-640mV** and the trigger level to **-640mV** as displayed in [Figure 32](#).
- g The f2 trace now has the frequency response with the N7024A probe attached. The already saved and displayed memory 1 trace has the frequency response of the coax cable. For comparison, grab the f2 trace and align it with the memory 1 trace, if needed as displayed in [Figure 32](#).
- h The frequency response of the N7024A probe is the difference between the f2 trace and memory 1 trace. Check the cutoff frequency by finding the 3 dB point. If the frequency is higher than 6 GHz, then the probe passes the test.

Notice that in the figure below, the N7024A probe passed the bandwidth verification test as the frequency response of the probe is higher than 6 GHz.



Figure 32 Frequency response of the N7024A probe

Performance Test Record

Serial #:

Date:

Tested by:

Recommended Next Test Date:

Table 13 Bandwidth Test Results

Test Limits	Result	Pass/Fail
Bandwidth higher than 6 GHz		

To verify if the N7022A main cable is damaged

At times, a damaged N7022A main cable may cause the N7022A+N7024A probe system to not meet its bandwidth specification even when the N7024A has passed the bandwidth verification test described in the previous section.

When the N7022A cable is connected to the N7024A probe, the oscilloscope utilizes a DSP correction filter to adjust the system response and correct the nominal signal loss from the N7022A main cable. In the case of a damaged main cable, this loss is more than the correction. Consequently, the probe may not meet its bandwidth specification when used in combination with such a damaged cable.

In such situations, it is recommended to verify whether or not the N7022A main cable is damaged using the procedure given below and replace the cable.

Prerequisites

The following are the prerequisites before you start verifying if the N7022A cable is damaged.

- The N7024A probe should have passed the bandwidth performance verification test using the procedure given in the previous section.
- The hardware and software setup configured at the completion of the N7024A bandwidth performance verification procedure should be retained for this procedure.

Procedure

- 1 From the hardware setup used in the N7024A bandwidth verification test (Figure 31), disconnect the calibration coax cable from the N7024A probe.

- 2 Connect the calibration coax cable to the N7022A main cable that you want to verify. Use an SMA f-f adapter to connect the two cables.
- 3 Then connect this main cable to the N7024A probe.

This hardware setup is illustrated in the figure that follows.

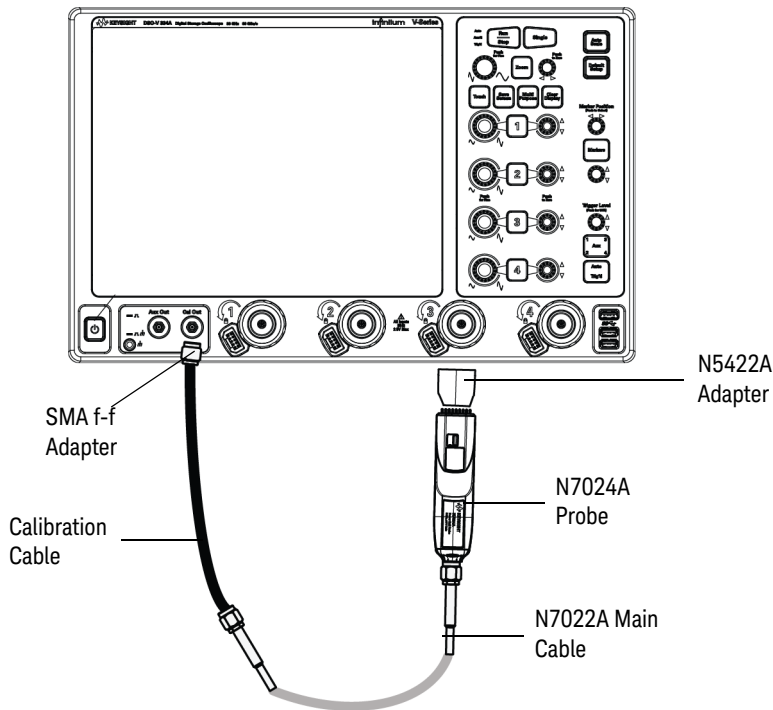

Figure 33 Calibration setup with the N7024A probe, main cable, and calibration cable

- 4 Choose **Setup > Probe Configuration...**
- 5 Select the tab of the oscilloscope's input channel to which the probe is connected.
- 6 In the **Probe Head** block, click **Select Head...** Select **N7022A:N7024A Main Cable** to configure the oscilloscope to consider the nominal loss from the N7022A main cable. Click **OK** and close the dialog.
- 7 The f2 trace now has the frequency response with the N7024A probe attached to the N7022A main cable. The already saved and displayed memory 1 trace has the frequency response of the coax test cable. See [Figure 32](#).

- 8 Consider the N7022A main cable as damaged if either of the following is true:
- The difference between the f2 trace and memory 1 trace is more than **3db** at 6 GHz or below.
 - The difference between the f2 trace and memory 1 trace is less than **3db** at 6 GHz or below but the f2 trace is clearly different from the f2 trace displayed in the sample figure below.



Figure 34 Frequency response of the N7024A probe with the N7022A main cable

Index

A

accessories, [9](#)
 static-safe, [51](#)
altitude, [24, 28](#)
AutoProbe 1 interface, [6](#)

B

bandwidth, [25, 29](#)
browser accessories, [12](#)

C

calibration setup, [83, 86](#)
care, probe, [7](#)
CE mark, [35](#)
characteristics, [23](#)
cleaning, [20](#)

D

damaged cable, [85](#)
DC input resistance verification, [76](#)

E

electrical specifications, [25, 29](#)
environmental specifications, [24, 28](#)

G

grounding probe, [18](#)

H

humidity, [24, 28](#)

I

input impedance model, [68](#)
input resistance, [25, 29](#)

inspecting, [18](#)

K

Keysight Technologies, contacting, [22](#)

M

Mechanical Characteristics, [25, 30](#)

N

N7024A standard accessories, [10](#)
N7032A, [11](#)
N7033A, [11](#)

O

orderable accessories, [14](#)
Orderable Parts, [14](#)

P

performance test record, [77, 85](#)
probe
 cable care, [7](#)
 cleaning, [20](#)
 grounding, [18](#)
 inspecting, [18](#)
 service, [21](#)
Probe Calibration dialog box, [56](#)
probe tips, [12](#)

R

repair, [21](#)
resistance testing, [76](#)
returning for service, [21](#)

S

service, [21](#)

SMA Adapter, [11](#)
standard accessories, [11](#)
static-safe accessories, [51](#)

T

temperature, [24, 28](#)
testing
 input resistance, [76](#)

W

warranted bandwidth verification, [79](#)

