

# Keysight N7040A/1A/2A Rogowski AC Current Probes

User Guide



# Notices

© Keysight Technologies 2017, 2021, 2022

No part of this manual may be reproduced in any form or by any means (including electronic storage and retrieval or translation into a foreign language) without prior agreement and written consent from Keysight Technologies as governed by United States and international copyright laws.

## Manual Part Number

N7040-97000

## Edition

Third Edition, September 2022

Available in electronic format only

## Warranty

THE MATERIAL CONTAINED IN THIS DOCUMENT IS PROVIDED "AS IS," AND IS SUBJECT TO BEING CHANGED, WITHOUT NOTICE, IN FUTURE EDITIONS. FURTHER, TO THE MAXIMUM EXTENT PERMITTED BY APPLICABLE LAW, KEYSIGHT DISCLAIMS ALL WARRANTIES, EITHER EXPRESS OR IMPLIED WITH REGARD TO THIS MANUAL AND ANY INFORMATION CONTAINED HEREIN, INCLUDING BUT NOT LIMITED TO THE IMPLIED WARRANTIES OF MERCHANTABILITY AND FITNESS FOR A PARTICULAR PURPOSE. KEYSIGHT SHALL NOT BE LIABLE FOR ERRORS OR FOR INCIDENTAL OR CONSEQUENTIAL DAMAGES IN CONNECTION WITH THE FURNISHING, USE, OR PERFORMANCE OF THIS DOCUMENT OR ANY INFORMATION CONTAINED HEREIN. SHOULD KEYSIGHT AND THE USER HAVE A SEPARATE WRITTEN AGREEMENT WITH WARRANTY TERMS COVERING THE MATERIAL IN THIS DOCUMENT THAT CONFLICT WITH THESE

TERMS, THE WARRANTY TERMS IN THE SEPARATE AGREEMENT WILL CONTROL.

## Technology Licenses

The hardware and/or software described in this document are furnished under a license and may be used or copied only in accordance with the terms of such license.

## U.S. Government Rights

The Software is "commercial computer software," as defined by Federal Acquisition Regulation ("FAR") 2.101. Pursuant to FAR 12.212 and 27.405-3 and Department of Defense FAR Supplement ("DFARS") 227.7202, the U.S. government acquires commercial computer software under the same terms by which the software is customarily provided to the public. Accordingly, Keysight provides the Software to U.S. government customers under its standard commercial license, which is embodied in its End User License Agreement (EULA), a copy of which can be found at <http://www.keysight.com/find/sweula>. The license set forth in the EULA represents the exclusive authority by which the U.S. government may use, modify, distribute, or disclose the Software. The EULA and the license set forth therein, does not require or permit, among other things, that Keysight: (1) Furnish technical information related to commercial computer software or commercial computer software documentation that is not customarily provided to the public; or (2) Relinquish to, or otherwise provide, the government rights in excess of these rights customarily provided to the public to use, modify, reproduce, release, perform, display, or disclose commercial computer software or commercial computer software documentation. No additional government requirements beyond those set forth in the EULA shall apply, except to the extent that those terms, rights, or licenses are explicitly required from all providers of commercial computer software pursuant to the FAR and the DFARS and are set forth specifically in writing elsewhere in the EULA. Keysight shall be under no obligation to update, revise or otherwise modify the Software. With respect to any technical data as defined by FAR 2.101, pursuant to FAR 12.211 and 27.404.2 and DFARS 227.7102, the U.S. government acquires no greater than Limited Rights as defined in

FAR 27.401 or DFAR 227.7103-5 (c), as applicable in any technical data. 52.227-14 (June 1987) or DFAR 252.227-7015 (b)(2) (November 1995), as applicable in any technical data.

## Safety Notices

### CAUTION

A CAUTION notice denotes a hazard. It calls attention to an operating procedure, practice, or the like that, if not correctly performed or adhered to, could result in damage to the product or loss of important data. Do not proceed beyond a CAUTION notice until the indicated conditions are fully understood and met.

### WARNING

A WARNING notice denotes a hazard. It calls attention to an operating procedure, practice, or the like that, if not correctly performed or adhered to, could result in personal injury or death. Do not proceed beyond a WARNING notice until the indicated conditions are fully understood and met.

# Contents

## 1 N7040A/1A/2A - Overview

<b>Introduction</b>	6
<b>Usage</b>	8
<b>Features</b>	9
<b>Specifications and Characteristics</b>	11
Probe Dimensions	13
<b>Inspecting the Probe</b>	14
<b>Cleaning the Probe</b>	15
<b>Probe Handling Precautions</b>	16
Precautions while Clipping / Unclipping the Coil	16
General Coil Handling Precautions	17

## 2 Safety and Regulatory Information

<b>Pre-Use Safety Checks and Warnings</b>	20
<b>Instrument Markings</b>	22

## 3 Setting up and Using the Probe

<b>Step 1 - Connect to a Compatible Keysight Oscilloscope</b>	24
Compatibility with Oscilloscopes	24
<b>Step 2 - Connect to a De-energized Conductor Under Test</b>	26
<b>Step 3 - Power Up</b>	27
Replacing Batteries	27
<b>Step 4 - Switch ON the Probe</b>	28
<b>Step 5 - Configure the Probe Settings in the Oscilloscope Software GUI</b>	29
On an Infiniium Oscilloscope	29
On an InfiniiVision Oscilloscope	31

## 4 Making Measurements

<b>Positioning the Rogowski Coil Accurately</b>	34
<b>Frequency Content above the Probe Bandwidth</b>	35
<b>Handling Probe's Sensitivity to External Currents and Voltages</b>	36
<b>Choosing an Appropriate Output Cable</b>	37
<b>Measurements Supported</b>	38

## 5 Returning the Probe for Repair or Service

Contacting Keysight Technologies 39

# 1 N7040A/1A/2A – Overview

Introduction / 6  
Usage / 8  
Features / 9  
Specifications and Characteristics / 11  
Inspecting the Probe / 14  
Cleaning the Probe / 15  
Probe Handling Precautions / 16

This chapter introduces the three models available under Keysight Rogowski AC Current probing range and lists their features, usage, characteristics, and specifications.

## Introduction

The N7040A/1A/2A Rogowski AC Current probes allow you to monitor AC current flowing through a conductor. These probes provide accurate, non-contact measurement of AC currents over a broad frequency range thereby ensuring high bandwidth performance with minimal disruption to the circuit under test.

These probes have a thin, lightweight, flexible, and simple to use clip-around Rogowski coil that enables currents to be measured in the most difficult to reach parts and confined spaces of a circuit under test. The coil size is independent of the magnitude of the current to be measured provided the di/dt ratings for the probes are not exceeded.



Figure 1 N7040A/1A/2A Probe Components (The figure shows the N7042A probe)

Component	Description
Rogowski Coil	The sensor loop of the probe that is clipped around a conductor under test. This coil is thin and delicate and must be handled with care. Refer to the topic " <a href="#">Probe Handling Precautions</a> " on page 16 to know more. Refer to the <a href="#">Table on page 13</a> for the Rogowski coil's length (circumference) and thickness applicable for the three models.
Free end of the Coil	Use this free end to clip / unclip the coil. Refer to the topic " <a href="#">Probe Handling Precautions</a> " on page 16 to know about the correct insertion and handling techniques while clipping / unclipping the coil.
Ferrule	Insert the free end of the coil into the ferrule while clipping / unclipping the coil.

Component	Description
Output Cable	0.5m BNC to BNC 50Ω cable to establish connectivity between the probe and oscilloscope. In order to maintain safety, the BNC terminal must be connected to an equipment that is separated from hazardous voltages by at least double insulation.
Connecting Cable	The cable connecting the Rogowski coil and Integrator. Refer to the <a href="#">Table on page 13</a> for the cable length applicable for the three models.
External Power Adapter (DC) Socket	5.5mm Jack socket to connect to an external adapter to power the probe using an external DC supply. Refer to the topic " <a href="#">Step 3 - Power Up</a> " on page 27 to know more.
Power Button	The push button to switch the probe ON / OFF.
Status Indicator LED	The LED adjacent to the Power button to indicate the current status of the probe. <ul style="list-style-type: none"> <li>▪ <b>Green</b> - Indicates that the probe is switched ON. Also indicates that the batteries used in the probe are charged.</li> <li>▪ <b>Red</b> - Indicates that the batteries used in the probe are depleted and must be replaced.</li> <li>▪ <b>Off</b> - Indicates that the probe is switched OFF.</li> </ul>
BNC Output Socket	Use this socket to connect the BNC output cable to the probe.
Batteries	Four standard 1.5V AA alkaline batteries. Battery Life is 25 hours (typical). Refer to the topic " <a href="#">Step 3 - Power Up</a> " on page 27 to know more.
Power Supply Adapter	The power supply adapter (part number 0950-6484) is also included with the probe to power the probe using an external DC supply. Refer to the topic " <a href="#">Step 3 - Power Up</a> " on page 27 to know more.

## Usage

- For Power converter development and diagnostics. Following are some examples:
  - In MOSFET or IGBT devices as small as TO-220 or TO-247 in case of the N7042A probe.
  - In MOSFET or IGBT devices as small as TO-247 or around the terminals of large power modules in case of the N7040A / N7041A probes.
  - In bond wires in power devices
- To measure power losses in semiconductors
- To monitor currents in small inductors, capacitors, snubber circuits, etc
- To measure small AC current on a conductor with high DC current or in the presence of a high DC magnetic field. An example can be monitoring capacitor ripple.
- To measure high frequency sinusoidal, pulsed, or transient currents from power frequency to rf applications
- To measure current in motor drives and in particular power quality measurements in VSD, UPS or SMPS circuits
- To evaluate switching performance of power switches (double pulse tester)
- To measure high order harmonics



## Features

Keysight provides three models (*N7040A*, *N7041A*, and *N7042A*) under the Rogowski AC Current probes. The following tables list the key features of each of these models.

### N7040A



- 4.5mm thick miniature clip-around Rogowski coil with 5kV peak insulation.
- A novel electrostatic shielded Rogowski coil providing excellent immunity to interference from fast local  $dV/dt$  transients or large 50/60Hz voltages
- Peak current rating upto 3.0kA
- -3dB high frequency bandwidth upto 23MHz
- -3dB low frequency bandwidth 3Hz
- Peak  $di/dt$  capability upto 80kA/ $\mu$ s
- Wide operating temperature from  $-40^{\circ}\text{C}$  to  $+125^{\circ}\text{C}$
- Terminated into  $1\text{M}\Omega$  scope input
- Positional accuracy typically  $\pm 2\%$

### N7041A



- 4.5mm thick miniature clip-around Rogowski coil with 5kV peak insulation.
- A novel electrostatic shielded Rogowski coil providing excellent immunity to interference from fast local  $dV/dt$  transients or large 50/60Hz voltages
- Peak current rating upto 0.6kA
- -3dB high frequency bandwidth upto 30MHz
- -3dB low frequency bandwidth 12Hz
- Peak  $di/dt$  capability up to 40kA/ $\mu$ s
- Wide operating temperature from  $-40^{\circ}\text{C}$  to  $+125^{\circ}\text{C}$
- Terminated into  $1\text{M}\Omega$  scope input
- Positional accuracy typically  $\pm 2\%$

N7042A



- 1.7mm thick ultra thin miniature clip-around Rogowski coil with 1.2kV peak insulation.
- Peak current rating upto 300A
- -3dB high frequency bandwidth upto 30MHz
- -3dB low frequency bandwidth 9.2Hz
- Peak di/dt capabilities upto 20kA/μs
- Wide operating temperature range -40°C to +125°C
- Terminated into 1MΩ scope input
- Positional accuracy typically ±2%
- Non-intrusive and loads the circuit under test by only a few pH

## Specifications and Characteristics

Table 1 Electrical Characteristics



Characteristic	N7040A	N7041A	N7042A
LF (-3dB) Bandwidth 	3.0 Hz	12 Hz	9.2 Hz
HF (-3dB) Bandwidth 	23 MHz	30 MHz	30 MHz
Peak Current	3000 A	600 A	300 A
Droop Peak Current	2.8 %/ms	11 %/ms	9 %/ms
Peak di/dt	80kA/ $\mu$ s	40kA/ $\mu$ s	20kA/ $\mu$ s
Absolute Maximum di/dt Ratings	100kA/ $\mu$ s (peak) / 1.2kA/ $\mu$ s (rms)	100kA/ $\mu$ s (peak) / 1.2kA/ $\mu$ s (rms)	70kA/ $\mu$ s (peak) / 1.2kA/ $\mu$ s (rms)
Sensitivity	2mV/A (500:1)	10mV/A (100:1)	20mV/A (50:1)
Output Load	>=100kohm (1Mohm scope input)		
Calibration	Calibrated to $\pm$ 0.2% reading with conductor positioned central in the coil loop		
Positional Accuracy	+/-2% variation of accuracy (Refer to the topic " <a href="#">Positioning the Rogowski Coil Accurately</a> " on page 34 to know more about how positional accuracy can help you obtain best measurements.)		
Linearity	$\pm$ 0.05% of reading		
Max Noise	8 mVp-p	10 mVp-p	15 mVp-p
Coil insulation	5kV Peak	5kV Peak	1.2kV Peak
DC Offset	$\pm$ 3mV maximum at 25°C		

Table 2 External DC Power Supply Characteristics

Characteristic	N7040A / N7041A / N7042A
DC Supply Voltage	12Vdc (+/-10%)
DC Quiescent Current	60mA @12VDC – standard alkali battery supplied with probe
DC Socket Type	5.5mm Jack Socket – Centre Positive Tip
Adapter Supply Voltage	100 – 240VAC
Adapter Supply Frequency	50 – 60Hz
Adapter Supply Current	450mA Max @ 100VAC Input
Supply Voltage Fluctuation	up to 10%

**Table 3 Mechanical Characteristic**

Characteristic	N7040A	N7041A	N7042A
Weight Includes Integrator, connecting cable, and Rogowski coil (without batteries)	10.8 Ounces (306.1 g)	10.0 Ounces (283.4 g)	9.6 Ounces (272 g)
Rogowski Coil Length (Circumference)	200mm	100mm	80mm
Rogowski Coil Thickness	4.5mm	4.5mm	1.7mm
Coil to Integrator Cable Length	4m	2.5m	2.5m
Output BNC Cable Length	0.5m		
Integrator Enclosure Dimensions	Refer to "Probe Dimensions" on page 13		
Minimum Bend Radius of the Coil	14mm	14mm	10mm

**Table 4 Environmental Characteristics**

Characteristic	N7040A	N7041A	N7042A
Use	For indoor use only		
Temperature (operating)	Coil and Cable: -40°C to +125°C Integrator: 0°C to +40°C	Coil and Cable: -40°C to +125°C Integrator: 0°C to +40°C	Coil and Cable: -20°C to +125°C Integrator: 0°C to +40°C
Altitude (operating)	3000 m		
Altitude (non-operating)	15000 m		
Maximum relative humidity	80% for temperatures up to 31°C decreasing linearly to 50% relative humidity at 40°C		
Installation Category	Installation Category III, Pollution Degree 2.	Installation Category III, Pollution Degree 2.	Installation Category II, Pollution Degree 2.
Overvoltage Transient	Cat III 600V	Cat III 600V	Cat II 600V

Probe Dimensions

The N7040A / N7041A / N7042A probe dimensions shown below are in millimeters.

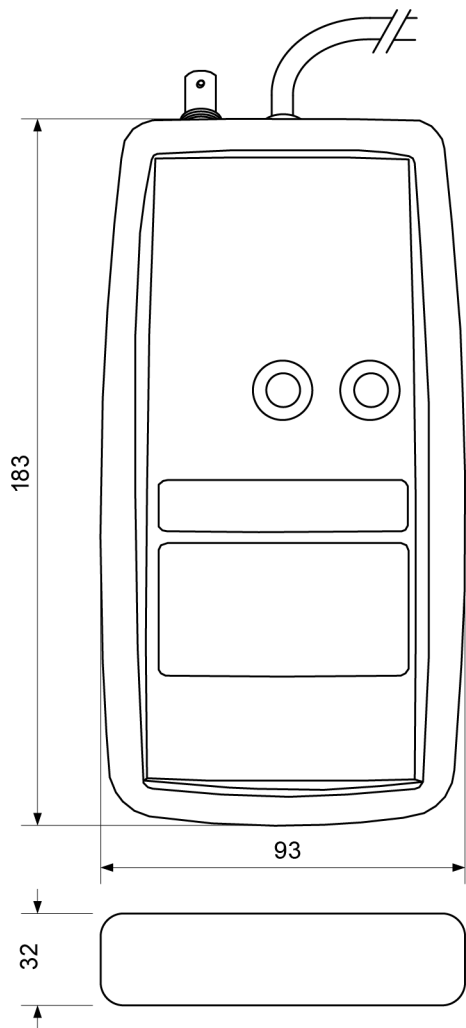

**N7040A / N7041A / N7042A Probe Integrator Dimensions**

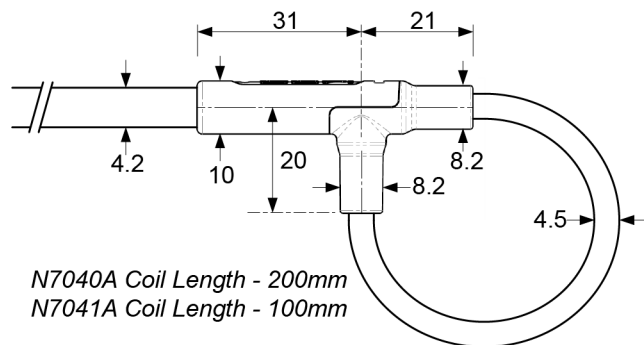

**N7040A and N7041A Coil and Cable Dimensions**

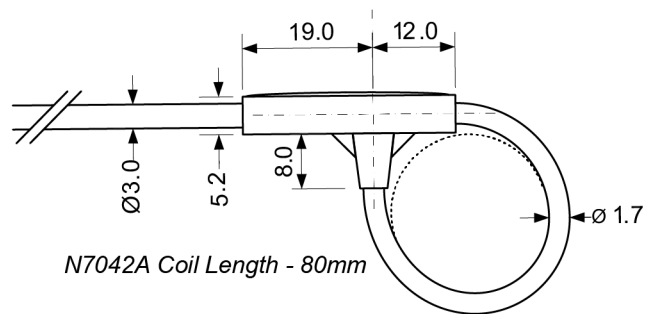

**N7042A Coil and Cable Dimensions**

Refer to [Table on page 13](#) to get information on mechanical characteristics of these probes.

## Inspecting the Probe

- Inspect the shipping container for damage.  
Keep the damaged shipping container or cushioning material until the contents of the shipment have been checked for completeness and the probe has been checked mechanically and electrically.
- Check the accessories. If the contents are incomplete or damaged, notify your Keysight Technologies Sales Office.
- Inspect the probe. If there is mechanical damage or defect, or if the probe does not operate properly, notify your Keysight Technologies Sales Office.
- If the shipping container is damaged, or the cushioning materials show signs of stress, notify the carrier as well as your Keysight Technologies Sales Office. Keep the shipping materials for the carrier's inspection. The Keysight Technologies office will arrange for repair or replacement at Keysight Technologies' option without waiting for claim settlement.

## Cleaning the Probe

You should inspect the Rogowski coil and cable regularly to prevent any surface contamination.

If the coil or cable requires cleaning:

- 1 Disconnect the probe from the oscilloscope, external power supply, and any circuit under test.
- 2 Turn the probe OFF.
- 3 Gently clean the cable and coil with a soft cloth dampened with a mild soap and water solution.
- 4 Wipe with clean water to remove the detergent and then dry thoroughly with a clean cloth.

**WARNING**

Do not try to clean the probe using cleaners containing organic solvents such as benzine, alcohol, acetone, ether, ketones, thinners, or gasoline. These may cause discoloration or damage. Make sure the probe is completely dry before reconnecting it for use.

---

## Probe Handling Precautions

The extremely thin and flexible qualities of the Rogowski coil makes it delicate and fragile and necessitates that it should be handled with care to prolong its life. The following sections provide instructions for proper handling of the coil and list some precautions that should be taken to avoid damage to the coil.

### Precautions while Clipping / Unclipping the Coil

- Hold the probe's ferrule as shown in the picture below while clipping / unclipping the coil.

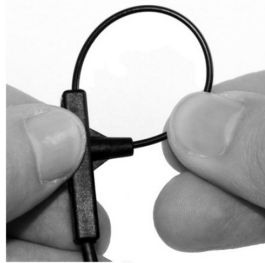

- Unclip the coil from its free end as shown in the picture below.

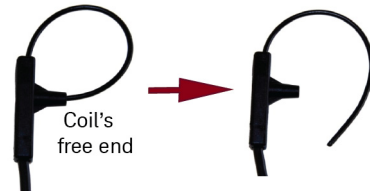

- For the N7040A / N7041A probes, ensure that the coil is correctly and fully inserted inside the probe's ferrule as illustrated in the figure below.

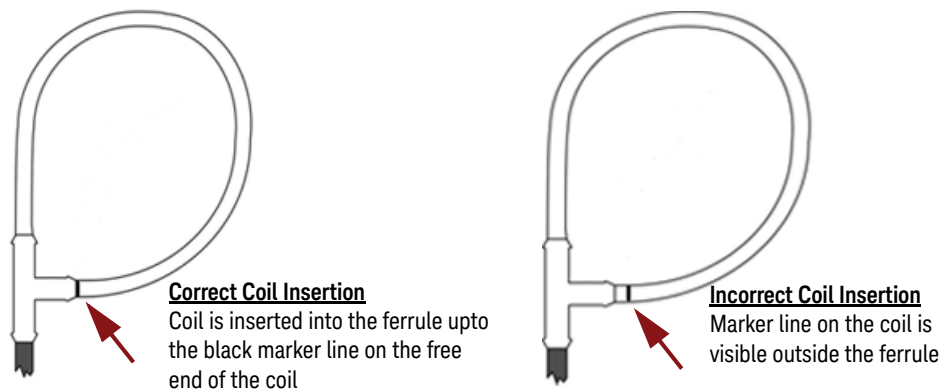

- For the N7042A probe, the coil has a friction fit. It is considered fully inserted into the ferrule when you can no further ease the coil's free end into the ferrule.

### CAUTION

If the coil is inserted correctly inside the ferrule, the coil will remain in place until released. If the coil is inserted incorrectly, the coil is likely to spring open while in use. Also, the accuracy of measurements will be greatly impacted.



## General Coil Handling Precautions

**CAUTION**

- Never force the free end of the coil into the ferrule. This may damage the coil insulation.
  - Take care not to put any force onto the cable attached to the coil. This may damage the coil.
- 

**CAUTION**

While bending the coil around a conductor, keep the minimum bend radius of the coil into consideration to avoid damage to the coil.

N7040A - 14 mm

N7041A - 14 mm

N7042A - 10 mm

---

**NOTE**

It is recommended to store the coil in its protective case when not in use.

---



## 2 Safety and Regulatory Information

Pre-Use Safety Checks and Warnings / 20

Instrument Markings / 22

These probes have been designed and tested in accordance with accepted industry standards, and have been supplied in a safe condition. These probes conform to international standards including IEC 61010-1 and IEC 61010-2-032.

Throughout this manual and specifically in this chapter, there are information and warnings that must be followed by the user to ensure safe operation and to maintain the product in a safe condition. If the probe is used in a manner not specified by the manufacturer, the protection provided by the equipment may be impaired.

## Pre-Use Safety Checks and Warnings

**WARNING**

Indoor Use Only. Do not operate in wet / damp environments. Keep product surfaces dry and clean.

Do not operate in an explosive environment.

---



**CAUTION**

The intended use of these probes is for the measurement of AC current. Keysight Technologies accepts no responsibility for any damage resulting from careless use, or failure to observe these instructions.

---



**WARNING**

If HAZARDOUS LIVE voltages are present and accessible in the installation, appropriate protective measures must be taken to avoid electric shock.

---



**WARNING**

The integrity of the insulation around the Rogowski coil must be VISUALLY INSPECTED before and after each use, and the probe must NOT BE USED if there are signs of coil damage.

---



**WARNING**

Be extremely careful when using the coil of the probe on uninsulated conductors. The power of the uninsulated conductor must be turned off when applying or removing the probe's coil from this conductor.

In addition, make sure that the probe is never used at voltages greater than its voltage rating (safe PEAK working voltage) which is clearly labeled on the probe cable adjacent to the coil. For N7040A and N7041A, it is 5kV peak and for N7042A, it is 1.2kV peak.

---

**WARNING**

Voltage ratings are only valid if the 'free end' of the coil is fully inserted into the probe's ferule, and remains fully inserted during use. Refer to the topic "[Probe Handling Precautions](#)" on page 16 to know more.

---

**WARNING**

The voltage ratings are appropriate for intermittent use of the probe as a test instrument and not for continuous use in a permanent installation.

The ratings are derived from the following standard test:

- N7042A coil (rated for 1.2kV peak) is flash tested for one minute at 3.0kVrms using a 50Hz sine-wave voltage.
  - N7040A and N7041A coils (rated for 5kV peak) are flash tested for one minute at 8kVrms using a 50Hz sine-wave voltage.
- 

**CAUTION**

Though these probes are capable of handling huge current overloads without damaging or saturating the probes, it is crucial that the absolute maximum rated di/dt for the probe is not exceeded. Refer to the [Table on page 13](#) to know these ratings.

---

**WARNING**

These probes and the oscilloscope must be properly grounded when used. Making the connection between the oscilloscope and probe using the BNC cable grounds the BNC input for the probe.

Properly connecting the oscilloscope's three prong power cord to the power outlet grounds the oscilloscope. See the oscilloscope user manual for more information on proper oscilloscope grounding.







---

**CAUTION**

Ensure that the signals are within the LF and HF Bandwidth range of the probes. Refer to the [Table on page 13](#) to know about the supported bandwidth range for your probe.

---

## Instrument Markings

Marking	Description
	<p>KC certification mark to demonstrate compliance with the South Korean EMC requirements. South Korean Class A EMC declaration This equipment is Class A suitable for professional use and is for use in electromagnetic environments outside of the home.</p>
	<p>The CE mark is a registered trademark of the European Community. ISM GRP 1-A denotes the instrument is an Industrial Scientific and Medical Group 1 Class A product. ICES/NMB-001 indicates product compliance with the Canadian Interference-Causing Equipment Standard.</p>
	<p>This symbol indicates the Environmental Protection Use Period (EPUP) for the product's toxic substances for the China RoHS requirements.</p>
	<p>A registered trademark of the Spectrum Management Agency of Australia. This signifies compliance with the Australia EMC Framework regulations under the terms of the Radio Communication Act of 1992.</p>
	<p>Notice for the European Community: This product complies with the WEEE Directive (2002/96/EC) marking requirements. The affixed label indicates that you must not discard this electrical/electronic product in domestic household waste. Product Category: With reference to the requirement types in the WEEE Directive Annex I, this product is classed as a "Monitoring and Control Instrumentation" product. Do not dispose in domestic household waste. To return unwanted products, contact your local Keysight office.</p>
	<p>The product is marked with this symbol when it is necessary for the user to refer to the instructions in the documentation.</p>
	<p>This symbol indicates a risk of electric shock. Refer to this manual for more information.</p>

# 3 Setting up and Using the Probe

- Step 1 - Connect to a Compatible Keysight Oscilloscope / 24
- Step 2 - Connect to a De-energized Conductor Under Test / 26
- Step 3 - Power Up / 27
- Step 4 - Switch ON the Probe / 28
- Step 5 - Configure the Probe Settings in the Oscilloscope Software GUI / 29

## Step 1 - Connect to a Compatible Keysight Oscilloscope

Compatibility with Oscilloscopes

### NOTE

You can use these probes with any Keysight Infiniium or InfiniiVision oscilloscope that has the **1MΩ** BNC input.

Infiniium Oscilloscopes	InfiniiVision Oscilloscopes
S-Series	6000L Series
9000 Series	6000 X-Series
9000 H-Series	4000 X Series
	3000 X Series
	3000T X Series
	2000 X Series
	1000 X Series
	1000 Series
Infiniium Software Version	InfiniiVision Software Version
Compatible with all Infiniium software versions Recommended version: 6.10 or higher	Compatible with all InfiniiVision software versions

### To connect to a compatible Keysight oscilloscope

Before you start setting up the probe, ensure that all safety warnings and precautions listed in the topic "[Pre-Use Safety Checks and Warnings](#)" on page 20 and 19 are followed.

- 1 Connect the probe's BNC output connector to the oscilloscope's BNC input connector using the BNC cable provided with the probe.

### WARNING

Grounding is critical to the safe operation of the probe. This connection using the BNC cable grounds the probe and coil to a properly grounded oscilloscope.

This connection must always be made **BEFORE** the coil is wrapped around the conductor under test and must not be removed until the coil has been removed from around the conductor under test.

Extreme caution needs to be taken not to damage coil insulation when placing or removing coil around sharp conductors.



**CAUTION**

When disconnecting the BNC cable from the oscilloscope, be sure to release the lock, then pull the connector. Forcibly pulling the connector without releasing the lock, or pulling on the cable will result in damage to the connector.

---

## Step 2 - Connect to a De-energized Conductor Under Test

### WARNING

Visually inspect the Rogowski coil to check for the integrity of the insulation around the coil. The probe must NOT BE USED if there are any signs of damage.

---

- 1 Unclip the coil from its free end as described in the ["Probe Handling Precautions"](#) on page 16.
- 2 Make a loop of the Rogowski coil around the de-energized conductor to be measured.

### CAUTION

When bending the Rogowski coil around a conductor, avoid tight bends and sharp edges that could damage the coil.

See [Table 3 on page 12](#) for information on minimum bend radius for the coil.

---

The positioning of the coil around the conductor can impact the accuracy of your measurements. Refer to the topic ["Positioning the Rogowski Coil Accurately"](#) on page 34 to know more.

- 3 Insert the free end of the coil fully inside the probe's ferrule as described in the ["Probe Handling Precautions"](#) on page 16. Ensure that the loop is closed properly.
- 4 Re-energize the conductor under test.

## Step 3 - Power Up

**CAUTION**

Before applying power, ensure that all connections to the probe have been made. Also, verify that all safety precautions have been taken.

---

You can power up the N7040A/41A/42A probes by using:

- **External DC power supply** - The DC voltage must be 12V ( $\pm 10\%$ ).

**CAUTION**

The external power supply adapter (Keysight part number - 0950-6484) provided with the probe must be used.

---

- **Batteries** - Four standard 1.5V alkaline AA batteries provided with the probe.

**NOTE**

When the external DC supply is present, the batteries are inoperative and the external DC voltage powers the probe.

---

When operating with the external power supply adapter, refer to [Table 2, "External DC Power Supply Characteristics,"](#)

### Replacing Batteries

The Status Indicator LED adjacent to the Power button on the probe glows Red indicating low battery. To replace the battery, switch off the probe, remove the battery cover, and replace with standard AA alkaline batteries.

**NOTE**

It is recommended that the circuit under test is de-energised or the probe is removed from the test circuit before replacing the batteries.

---

## Step 4 - Switch ON the Probe

- 1 Use the Power push-button on the probe to switch OFF/ON the probe by pressing and releasing this button. The Status LED adjacent to the Power button turns Green indicating that the probe is switched ON.
- 2 To switch OFF the probe, depress the Power button fully.

### NOTE

After you switch ON the probe, wait for upto 2 minutes before you start making any measurements. This is to allow the probe to warm up so that accurate measurements can be taken.

---

## Step 5 - Configure the Probe Settings in the Oscilloscope Software GUI

After making hardware connections, perform the following steps in the *Infiniium / InfiniiVision Oscilloscope software GUI* to configure probe settings such as identifying the type of probe attached to the oscilloscope and setting the appropriate input impedance and attenuation ratio etc. These settings are required to get accurate measurement results.

On an Infiniium Oscilloscope

- 1 Choose **Setup > Probe Configuration...** to open the **Probe Configuration** dialog box. The N7040A/41A/42A probe is not automatically identified by the oscilloscope and therefore not displayed as connected to the scope's channel.

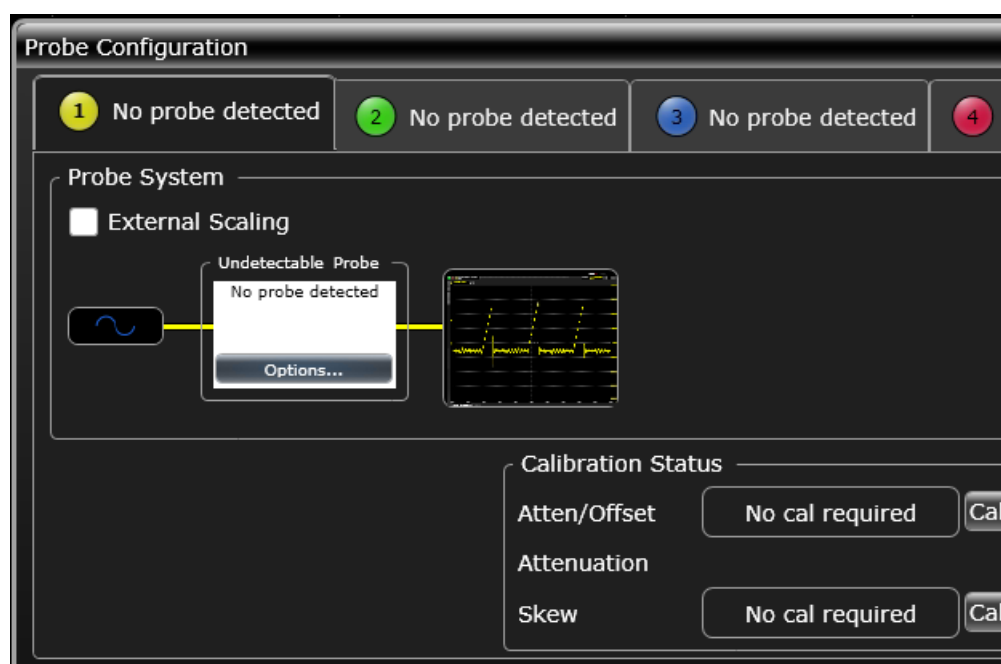

- 2 To manually identify the type of probe and configure its settings, click **Options...** displayed in the **Probe System** section of the scope channel to which the current probe is connected. In the above screen, the settings for the N7042A probe connected to Channel 1 are being configured.
- 3 The **Probe** dialog box is displayed. Select the **Current Probe attached** option from the **Probe Type** drop-down listbox.

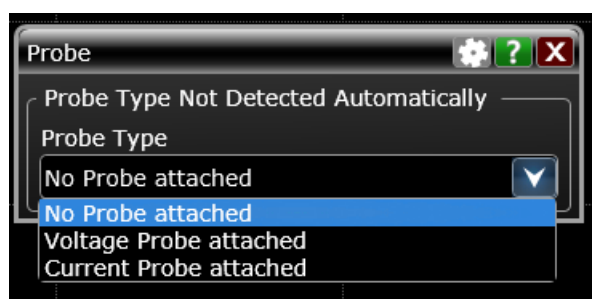

- 4 From the **Current Probe** drop-down listbox, select the attenuation ratio for your current probe to match the Output/Input ratio (in V/A) (printed on the label on the front side of the probe).

- N7040A..... 0.002 V/A (500:1)
- N7041A.....0.01 V/A (100:1)
- N7042A..... 0.02 V/A (50:1)

In the example below, the 0.02 V/A has been selected for the N7042A probe.

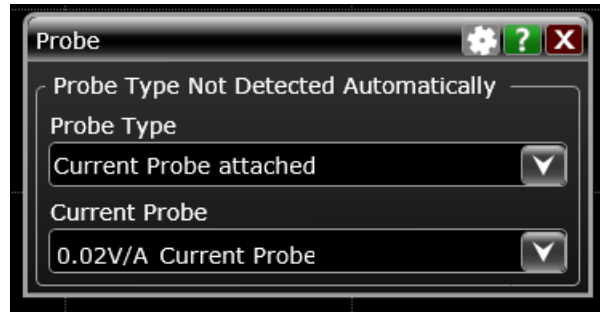

On identifying the probe type, the current probe is now displayed in the Probe configuration dialog box.

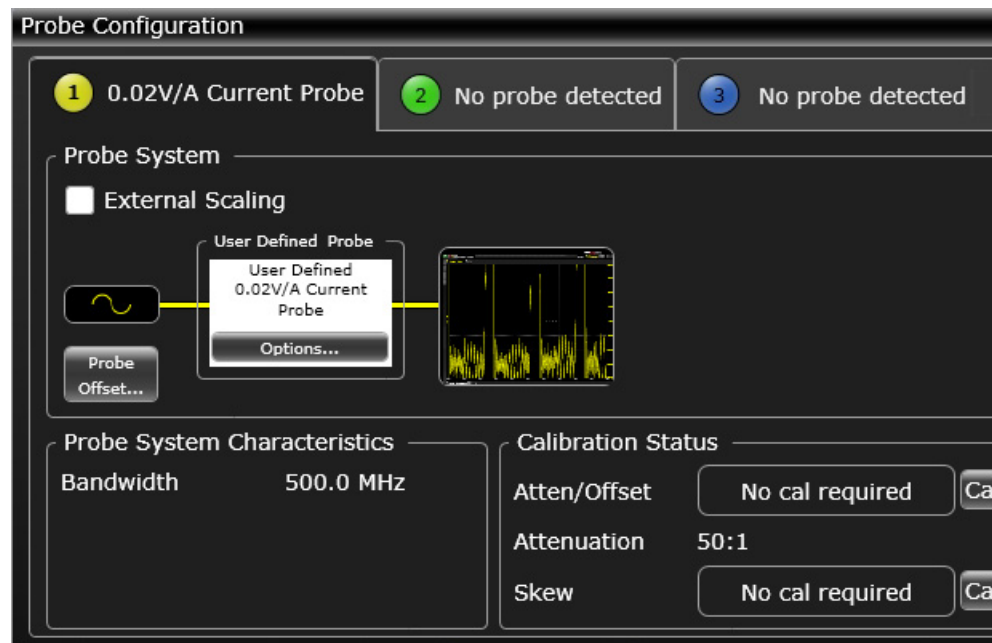

- 5 Configure the scope channel settings to which the current probe is attached. To do so, access the **Channel** dialog box by clicking **Setup > Channel <N>** option from the menu on the top.
- 6 In the Channel dialog box, confirm that the following settings are configured correctly for the channel.
  - The Vertical scale unit of the oscilloscope should be set to **Amps**. In the **Scale** field, select the desired Amps per division scale for a waveform.
  - The **Input Impedance** of the oscilloscope channel must be set to **1 MΩ** to make accurate measurements.
  - Set the oscilloscope's **Input Coupling** to **AC** to remove any DC offset voltage from the waveform. These settings are highlighted in the following screen.

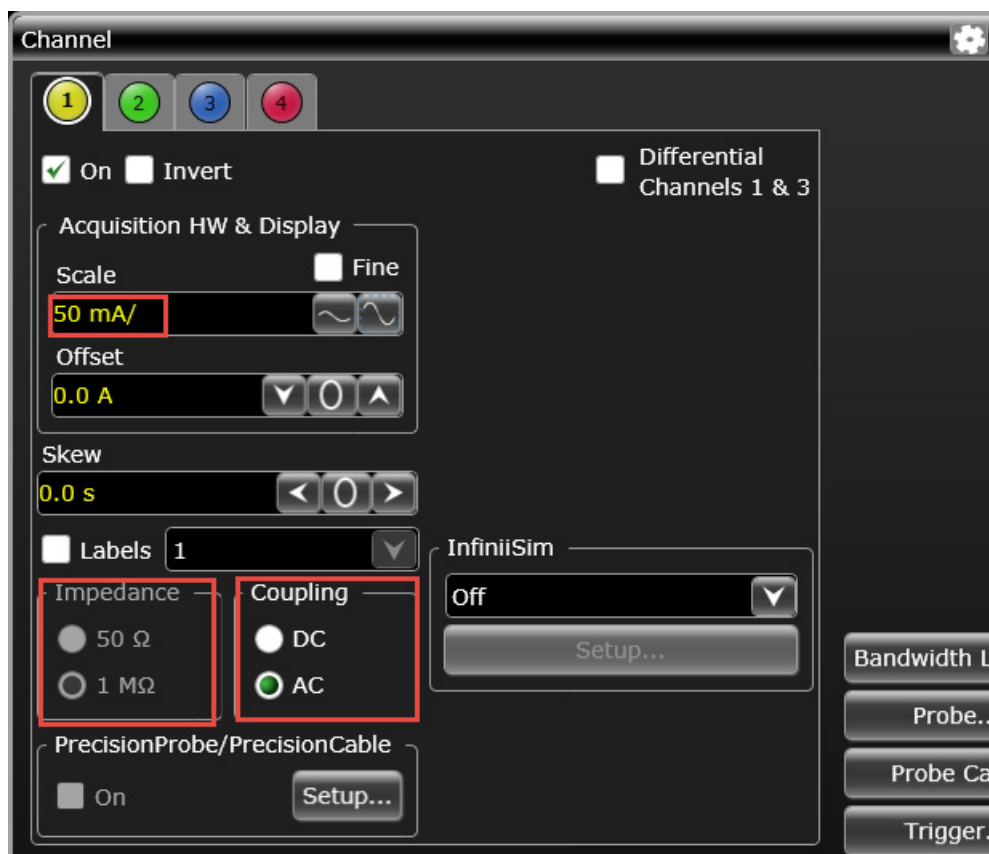

- 7 Measure the current and observe the waveform on the oscilloscope. Remember that the actual current will be greater or less than the oscilloscope waveform if the probe attenuation has not been set accurately.

On an InfiniiVision Oscilloscope

The N7040A/41A/42A probe is not automatically identified by the oscilloscope and therefore you need to manually set the attenuation factor and units for the probe.

- 1 Press the channel key to which the current probe is attached to display the Channel <N> menu.
- 2 Press the **Coupling** softkey to set the oscilloscope's **Input Coupling** to **AC** to remove any DC offset voltage from the waveform.
- 3 Press the **Impedance** softkey to set the input impedance of the oscilloscope channel to **1 MΩ** to make accurate measurements.

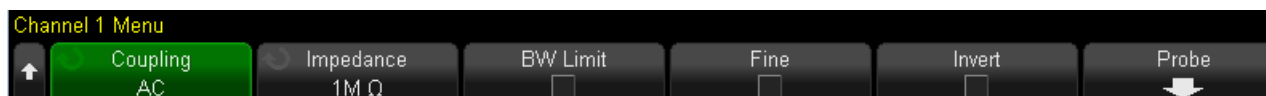

- 4 Press the **Probe** softkey to display the channel's probe menu.



- 5 Press the **Units** softkey to select **Amps** as the measurement unit for the connected probe.

- 6 Press the **Probe** softkey until you have selected how you want to specify the attenuation factor, choosing either Ratio or Decibels.



- 7 Rotate the Entry knob  to set the attenuation factor for your current probe. The attenuation factor must match the Output/Input ratio (in V/A) (printed on the label on the front side of the probe).

- N7040A..... 0.002 V/A (500:1)
- N7041A.....0.01 V/A (100:1)
- N7042A..... 0.02 V/A (50:1)

- 8 Measure the current and observe the waveform on the oscilloscope. Remember that the actual current will be greater or less than the oscilloscope waveform if the probe attenuation has not been set accurately.



## 4 Making Measurements

Positioning the Rogowski Coil Accurately /	34
Frequency Content above the Probe Bandwidth /	35
Handling Probe's Sensitivity to External Currents and Voltages /	36
Choosing an Appropriate Output Cable /	37
Measurements Supported /	38

This chapter provides guidelines that you would find useful in obtaining the best measurements accuracy using the N7040A/41A/42A probes. It also provides an overview of some relevant measurements that you can make using these probes on a compatible Keysight oscilloscope.

## Positioning the Rogowski Coil Accurately

You can achieve the maximum accuracy in your measurement results by ensuring that the Rogowski coil is positioned properly around the conductor under test.

- Position the Rogowski coil in such a manner that the conductor under test is encircled by the coil but is not adjacent to the ferrule or the probe cable attachment as illustrated by the shaded area in the picture below.
- The N7040A/41A/42A probes have been calibrated with the conductor near the center (indicated by *position A* in the picture below).

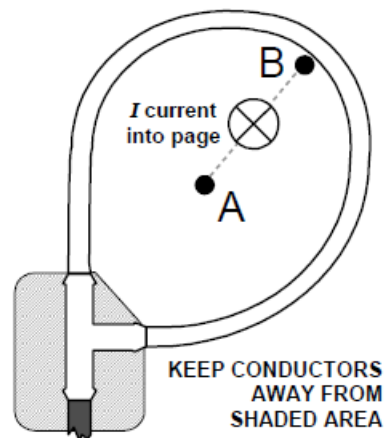

- The picture also shows the direction a positive current should pass through the coil loop to obtain a positive output voltage. For the best high frequency performance, the center of the current should lie on the dotted line shown from A to B, where A represents the center of the coil and B represents half way around the circumference of the coil.

## Frequency Content above the Probe Bandwidth

Attempting to make measures on signal sources which include higher frequency components will result in measurement accuracy issues. To make the most accurate measurements, the signals to be measured should not have frequency content above the probe's bandwidth and should have rise times greater than 20 ns.

## Handling Probe's Sensitivity to External Currents and Voltages

The sensitivity of the N7040A/41A/42A probes to currents that are outside the closed loop of the Rogowski coil is very small, provided that the external currents are less than the current rating of the probe or that such currents are relatively distant from the coil.

Following are some of the recommendations to handle probe's sensitivity to external currents and voltages.

- In the vicinity of a multi-turn conductor, the effects are far stronger than from a single conductor carrying the same current, and such positions should be avoided.
- If there is a surface with a high voltage very close to the coil and the voltage is subject to high rates of change (for example, 1kV/μs) or high frequency oscillations in the MHz range, then measurement errors can arise due to capacitive coupling to the coil.
- To check for any unwanted response to adjacent fields, it is recommended to quantify the output of the probe when close to (but not encircling) the conductor under test. This will reveal the magnitude of any unwanted responses to currents close to, but outside, the coil.

## Choosing an Appropriate Output Cable

The N7040A/41A/42A probes are shipped with a 0.5m BNC to BNC 50  $\Omega$  cable to establish connectivity between the probe and oscilloscope.

If needed, you may use a longer cable that meets the requirement of a 50  $\Omega$  single screened coaxial cable type.

Also, though the use of extension cables may not be problematic from the noise viewpoint but consideration should be given to the routing of very long cables.

### NOTE

---

## Measurements Supported

There are a number of measurements available in the Infiniium / InfiniiVision GUI that are relevant for AC current measurement using these probes. Some of these measurements are listed below. You can find a detailed description of each of the supported measurement in the online help for the Infiniium / InfiniiVision GUI.

Peak
Peak-Peak Contrast
RMS
Rise Time
Frequency

**NOTE**

For measurements such as RMS, there are two types available - AC and DC. Ensure that you select the type as AC for such measurements.

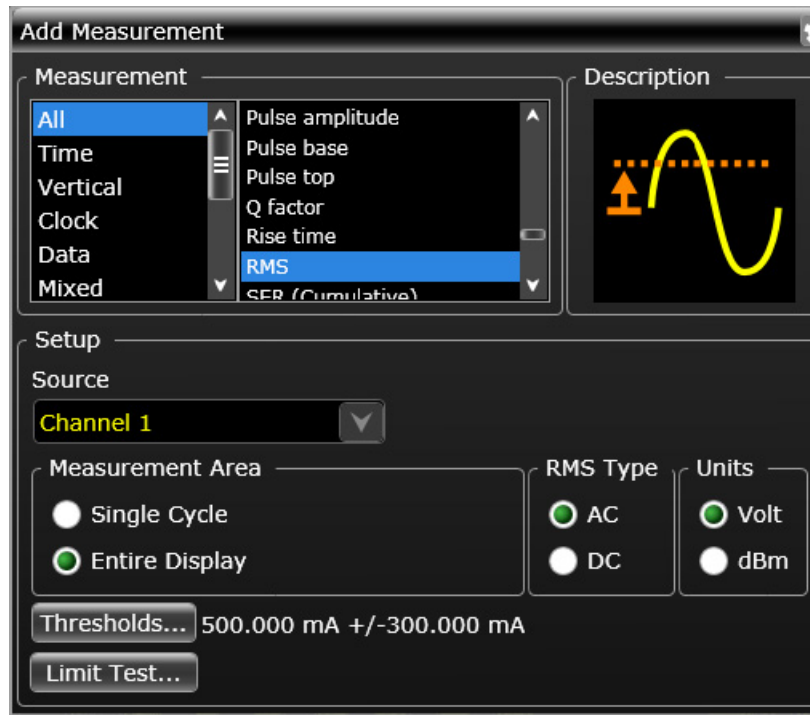

## 5 Returning the Probe for Repair or Service

If the probe is found to be defective, it is recommended to send it to a Keysight authorized service center for all repair and service needs.

If the probe is under warranty, normal warranty services apply. If the probe is not under warranty, repair costs will be applied.

### **WARNING**

Do not install substitute parts or perform any unauthorized modification to the instrument.

Only Keysight service centers should perform repair/maintenance on the equipment.

Only Keysight approved accessories should be used.

---

Perform the following steps before shipping the probe back to Keysight Technologies for repair / service.

- 1 Contact your nearest Keysight sales office for any additional details.
- 2 Write the following information on a tag and attach it to the malfunctioning equipment.
  - Name and address of owner
  - Product model number (for example, N7040A)
  - Product Serial Number (for example, MYXXXXXXXX)
  - Description of failure or service required
- 3 Protect the probe by wrapping in plastic or heavy paper. Use original packaging or comparable.
- 4 Pack the probe in the original carrying case or if not available, use bubble wrap or packing peanuts.
- 5 Place securely in sealed shipping container and mark container as "FRAGILE".

If any correspondence is required, refer to the product by serial number and model number.

### Contacting Keysight Technologies

For technical assistance, contact your local Keysight Call Center.

- In the Americas, call 1 (800) 829-4444
- In other regions, visit <http://www.keysight.com/find/assist>

Before returning an instrument for service, you must first call the Call Center.







